



Maha Bodhi School
2009 Continual Assessment 1
Mathematics

Name : _____ ()

Date : 3 March 2009

Class : Pr 5 _____

Total time for Booklets A and B : 50 min

PAPER 1
BOOKLET A

Questions 1 to 10 carry 1 mark each. Questions 11 to 15 carry 2 marks each.
For each question, four options are given. One of them is the correct answer.
Make your choice (1, 2, 3 or 4).

Shade the oval (1, 2, 3 or 4) on the Optical Answer Sheet.

(20 marks)

You are not allowed to use a calculator.

1. In 835 092, the digit 5 stands for _____.

- (1) 50
- (2) 500
- (3) 5000
- (4) 50000

2. What is $1000 - 100 + 10 - 1$?

- (1) 900
- (2) 909
- (3) 990
- (4) 999

3. This year, Benedict's mother is 4 times as old as he is. In 7 years' time, Benedict will be 18 years old. How old is his mother this year?

- (1) 44
- (2) 46
- (3) 65
- (4) 72

4. Which one of the following shows that more than $\frac{1}{2}$ of the square is shaded?

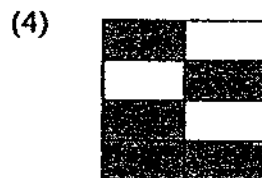
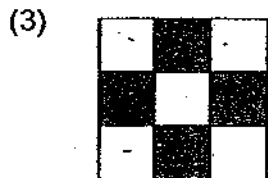
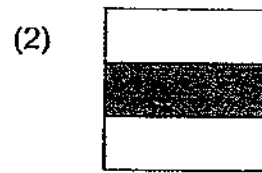

5. Meimei and Wenwen drank $\frac{4}{5}$ ℓ of water. Wenwen drank half as much as Meimei. How much water did Wenwen drink?

(1) $\frac{1}{2}$ ℓ.

(2) $\frac{1}{3}$ ℓ

(3) $\frac{2}{5}$ ℓ

(4) $\frac{4}{15}$ ℓ

6. Liwen shared a bag of sweets with Mona and Lisa. She gave $\frac{1}{3}$ of the sweets to Mona, $\frac{1}{4}$ to Lisa and kept 35 sweets for herself. How many sweets were there in the bag?

(1) 49

(2) 60

(3) 72

(4) 84

7. Write 5 thousands and 5 tenths in numerals.

- (1) 5000.05
- (2) 5000.5
- (3) 5050
- (4) 0.055

8. Dawn plans to construct a rectangular fence in her garden for her puppy as shown in the diagram below. What is the total length of the fence Dawn needs?

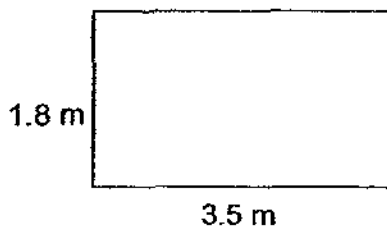

- (1) 5.3 m
- (2) 6.3 m
- (3) 10.6 m
- (4) 12.6 m

9. Xinhui exchanged a \$10 note for 50 coins. All the coins have the same value. What is the value of each coin?

- (1) 5¢
- (2) 10¢
- (3) 20¢
- (4) 50¢

10. Which one of the following shows the correct unit of measurements?

	Length	Mass	Capacity
(1)	cm	kg	m
(2)	km	g	ℓ
(3)	ℓ	g	ml
(4)	m	km	cm ³

11. Jane is older than Kim and Kim is older than Shawn. Russell is older than Jane. List the people from the oldest to the youngest.

- (1) Russell, Jane, Kim, Shawn
- (2) Jane, Kim, Shawn, Russell
- (3) Kim, Shawn, Russell, Jane
- (4) Shawn, Russell, Jane, Kim

12. Which one of the following is closest to 4?

(1) $3\frac{2}{3}$

(2) $3\frac{7}{10}$

(3) $4\frac{3}{11}$

(4) $4\frac{1}{4}$

13. There are 130 people in the cinema. $\frac{3}{5}$ of them are adults and the rest are children. If there are 4 more boys than girls, how many boys are there in the cinema?

(1) 24

(2) 28

(3) 30

(4) 41

14. Stephanie used 121.3 cm of string to tie a present in the shape of a cube as shown. 20.5 cm of the string is used for the ribbon. What is the length of each side of the box?

(1) 12.6 cm

(2) 16.8 cm

(3) 17.7 cm

(4) 23.6 cm



15. Which figure has only 1 line of symmetry?

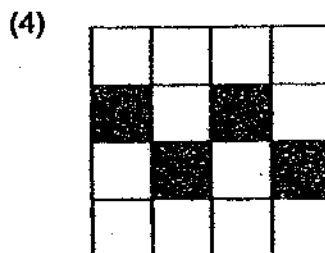
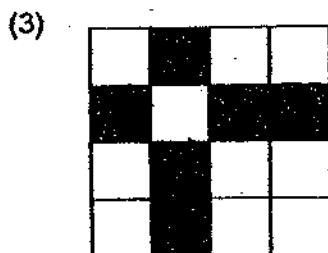
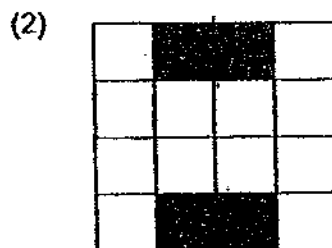
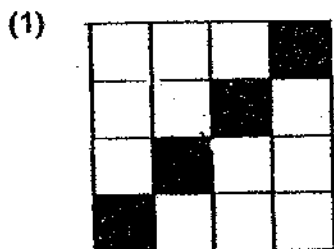



Maha Bodhi School
2009 Continual Assessment 1
Mathematics

Name : _____ ()

Date : 3 March 2009

Class : Pr 5 _____

Total time for Booklets A and B : 50 min

PAPER 1
BOOKLET B

Questions 16 to 25 carry 1 mark each. Write your answers in the spaces provided.
For questions which require units, give your answers in the units stated. (10 marks)
You are not allowed to use a calculator.

16. Arrange the numbers in ascending order:
639 892, 693 800, 619 892, 683 899

Ans: _____

17. Write 3 982 140 in words.

Ans: _____

18. Study the pattern below.

1×1	$= 1$
11×11	$= 121$
111×111	$= 12\,321$
$1\,111 \times 1\,111$	$= 1\,234\,321$

What is $111\,111 \times 111\,111$?

Ans: _____

19. Mrs Samad used 3 m of cloth to make 12 scarves. How much cloth was used to make 1 scarf?

Ans : _____ m

20. Find the value of $15\frac{1}{8} - 5\frac{3}{4}$.

Ans : _____

21. Express $2\frac{6}{7}$ as a decimal correct to 2 decimal places.

Ans : _____

22. Give any two numbers whose values lie between 7 and 7.1.

Ans: _____ and _____

23. $0.75 = \frac{3}{\square} = \frac{\square}{20}$

Ans : $\frac{3}{\square} = \frac{\square}{20}$

24. The figure below shows the weighing scale before and after the bananas are placed on it.

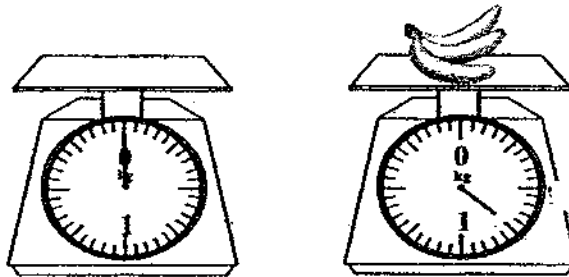

The same bananas are then placed on another weighing scale. Mark on the weighing scale the mass of the bananas.

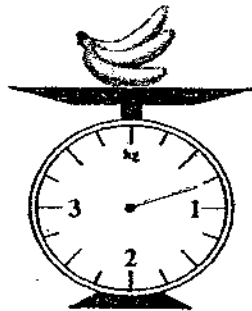

25. Andy watched a movie that lasted for $1\frac{3}{4}$ h. If the movie ended at 01 05, what time did it start? Express your answer in 24 h clock.

Ans : _____

Questions 26 to 30 carry 2 marks each. Show your working clearly in the space below each question and write your answers in the spaces provided.
For questions which require units, give your answers in the units stated. (10 marks)
You are not allowed to use a calculator.

26. Anne has 42 more stamps than Mark. Mark has 23 stamps fewer than Ben. If they have 1037 stamps altogether, how many stamps does Mark have?

Ans: _____ stamps

27. The sum of two fractions is 1. If one of the fractions is $\frac{3}{5}$ less than the other, find the product of the two fractions.

Ans : _____

28. Mr Yan baked a cake. He ate $\frac{1}{4}$ of it and gave $\frac{3}{5}$ of the remaining cake equally to his 3 children. What fraction of the cake did each of his 3 children get?

Ans : _____

29. Joan was afraid she did not have enough money for a book fair, so she borrowed \$20. After she spent \$50 at the book fair, she had \$12.50 left. How much money did she have originally?

Ans :\$ _____

30. How many more of the unit shape can you add in the space provided?
Write down the greatest possible number.

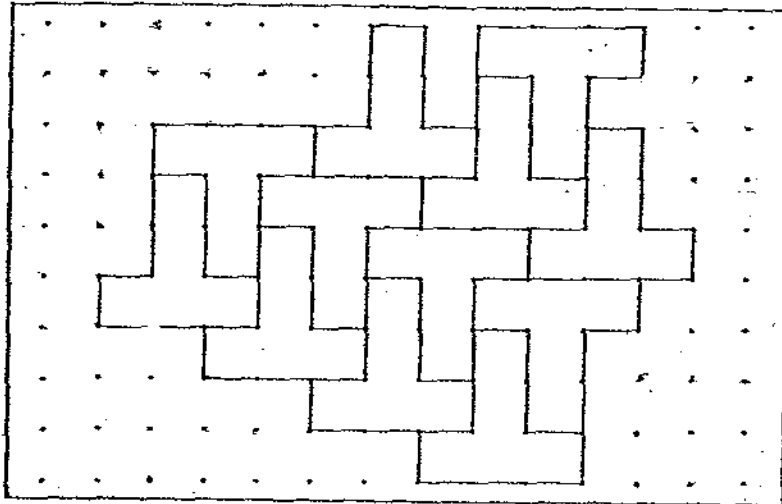

Ans : _____



Maha Bodhi School
2009 Continual Assessment 1

Mathematics

Name : _____ ()

Class : Pr 5 _____

Duration : 1 h 40 min

Date : 3 March 2009

Parent's Signature : _____

Paper 1	
Booklet A (20 marks)	
Booklet B (20 marks)	
Paper 2	
Q1 – 5 (10 marks)	
Q6 - 18 (50 marks)	
Total (100 marks)	

PAPER 2

Questions 1 to 5 carry 2 marks each. Show your working clearly in the space below each question and write your answers in the spaces provided.

For questions which require units, give your answers in the units stated. (10 marks)
You are allowed to use a calculator.

1. Nine bus stops are equally spaced along a bus route. The distance between the first stop and the third one is 600 m. How long is the bus route?

Ans : _____ m

2. How many different ways are there to arrange 4 children if they are standing in a row?

Ans : _____

3. A tank is $\frac{2}{7}$ full of water. When $5\frac{7}{8}$ l of water is poured into it, the tank will be $\frac{1}{3}$ full. What is the capacity of the tank?

Ans : _____ l

4. Issac wants to buy a new cap that costs \$5.25. He has only \$2.30. He can earn 50 cents an hour by helping his mother at her hawker stall. How many hours will Issac have to work in order to buy the cap? (Round off your answer to the nearest whole number.)

Ans : _____ h

5. A rectangular piece of paper was folded to form the figure shown below. What is the area of the piece of paper?

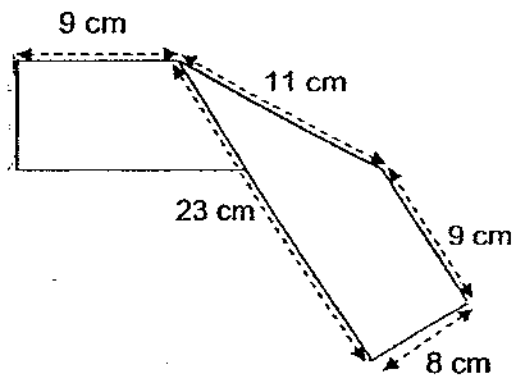

Ans : _____ cm²

For questions 6 to 18, show your working clearly in the space provided for each question and write your answers in the spaces provided. The number of marks available is shown in brackets [] at the end of each question or part-question. (50 marks)
You are allowed to use a calculator.

6. Michael usually walks from home to school and gets a lift on his friend's bicycle when he returns home. It takes him 40 minutes altogether. One day he travelled on the bicycle from home to school and back home, which took him 32 minutes. Assuming that the cycling speed is constant on both days, how much time would he need to travel to and from school at a constant speed on foot?

Ans : _____ [3]

7. $\frac{2}{3}$ of Mark's money is equal to $\frac{4}{7}$ of John's money. John has \$19 more than Mark. How much do they have altogether?

Ans : _____ [3]

8. The picture shows the cost of hamburgers and packets of fries.
Find
- the cost of a hamburger and
 - the cost of a packet of fries.



Ans: a) _____ [2]

b) _____ [1]

9. May is 1.4 m tall. She is 12 cm taller than her sister. If her brother's height is half the sum of the height of both the girls, how tall is her brother?

Ans : _____ [3]

10. A box filled with 100 metal balls has a mass of 120 kg. The same box when filled with 100 rubber balls has a mass of 95 kg. The mass of each metal ball is twice as heavy as each rubber ball. Find the mass of each rubber ball. Express your answer in grams.

Ans : _____ [3]

11. A man bought 450 sticks of satay. He divided them equally among 30 children. 12 children ate all the sticks of satay that were given to them. 7 children ate 9 sticks of satay each. The remainder ate 11 sticks of satay each. How many sticks of satay were not eaten?

Ans : _____ [4]

12. Tom had some marbles. He gave $\frac{1}{2}$ of them to Jenny and $\frac{1}{8}$ of the remainder to Auston. He bought another 144 marbles and then had as many marbles as he had at first. How many marbles did he have at first?

Ans : _____ [4]

13. Dominic and Javier had a total \$755.40. After each of them bought a tennis racket that cost \$128.95, Dominic had 4 times as much money left as Javier. How much money did Dominic have at first?

Ans : _____ [4]

14. The figure below is made up of 12 identical rectangles. The total area of the figure is 1296 cm^2 . Find the perimeter of the figure.



Ans: _____ [4]

15. The graph below shows the hourly sales at a foodcourt on a Thursday. Study the graph below and answer the questions that follow.

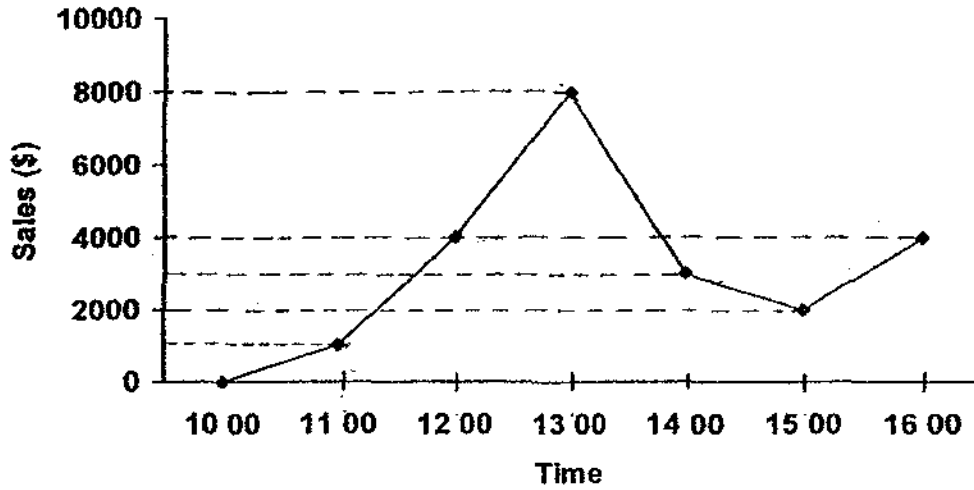

- a) At what time was the sales \$3000? _____ [1]
- b) Between which two timings was the increase in sales the greatest?
From _____ to _____ [1]
- c) What was the sales at 10:00? Give a reason for this amount of sales.
The sales at 10:00 was _____ because _____
_____ [2]

16. A businessman paid \$35,742 for an order of some handbags and dresses. Each handbag cost \$145 and each dress cost \$57 cheaper than each handbag. The businessman bought 9 more dresses than handbags. How many dresses did he buy?

Ans: _____ [5]

17. Joanne and her friends went to a restaurant for a buffet dinner. The charge for the buffet was \$24 per person and 1 person dines free for every 4 paying persons. How many people were there if they paid \$408 altogether?

Ans: _____ [5]

18. Ernest and Peter were playing a card game. In the 1st round, Ernest lost $\frac{1}{3}$ of his cards to Peter. In the 2nd round, Peter lost $\frac{1}{4}$ of the cards he had then to Ernest. In the last round, Ernest lost $\frac{1}{5}$ of the cards he had then to Peter. In the end, Ernest had 760 cards and Peter had 1324 cards. How many cards did Ernest have at first?

Ans : _____ [5]



*Remember to check your work!
Every mark counts.*

–End of Paper –

ANSWER SHEET

EXAM PAPER 2009

SCHOOL : MAHABODHI PRIMARY SCHOOL
 SUBJECT : PRIMARY 5 MATHEMATICS

TERM : CA 1

Q1	Q2	Q3	Q4	Q5	Q6	Q7	Q8	Q9	Q10	Q11	Q12	Q13	Q14	Q15
3	2	1	4	4	4	2	3	3	2	1	4	2	1	3

16) 619892, 639892, 683899, 693800

17) Three million, nine hundred and eight-two thousand, one hundred and forty.

18) 12345654321

19) 0.25m

20) $9\frac{3}{8}$

21) 2.86

22) 7.01 and 7.02

23) $3\frac{15}{4}$, $\frac{15}{20}$

24)

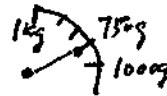

25) 2320

26) 324 stamps

27) $4/25$

28) $3/20$

29) \$42.50

30) 4

Paper 2

1) 2400m	2) 24
3) 123,375L	4) $\$5.25 - \$2.30 = \$2.95$ $\$2.95 \div 50\text{¢} = 5\text{R}9 = 6\text{h}$ Issac have to work 6 hours.

<p>5) $8\text{cm} \times (9+23)\text{cm} = 256\text{cm}^2$ The area of the piece of paper is 256cm^2</p>	<p>6) bicycle from home to sch \rightarrow $32\text{min} \div 2 = 16\text{min}$ foot from home to sch \rightarrow $40 - 16 = 24\text{min}$ to and from sch $\rightarrow 24 \times 2 = 48\text{min}$ He would need 48min.</p>
<p>7) 1 units = \$19 13 units = $\\$19 \times 13 = \\247 They have \$247 altogether</p>	<p>8) a) $(\\$7.65 \times 2) - \\$12.45 = \\$2.85$ = 1 hamburger 1 hamburger cost \$2.85. b) $\\$7.65 - (\\$2.85 \times 2) = \\$1.95$ = 1 packet of fries. 1 packet of fries cost \$1.95.</p>
<p>9) $1.4\text{m} = 140\text{cm}$ Brother $\rightarrow (140 - 12) + 140$ $= 268 \div 2 = 134\text{cm}$ Her brother is 134 cm tall.</p>	<p>10) Mass of 100 rubber ball $\rightarrow 120 - 95 = 25\text{kg}$ Mass of 1 rubber ball $\rightarrow 25000 / 100 = 250\text{ g}$</p>
<p>11) 86 stays <i>sticks of satay</i></p>	<p>12) 9 units $\rightarrow 144$ $(8 - 1) + 9\text{units} \rightarrow 16\text{units}$ $= (144 \div 9) \times 16 = 256\text{ marbles}$ He have 256 marbles at first.</p>
<p>13) $\\$755.40 - (\\$128.95 \times 2)$ $= \\$497.50 = 5\text{ units}$ 1 unit $\rightarrow \\$497.50 \div 5 = \\99.50 $(\\$99.50 \times 4) + \\128.95 $= \\$526.95$ Dominic have \$526.95 at first.</p>	<p>14) 156cm</p>
<p>15) a) 1400 b) 1200 to 1300 c) \$0 because the food court is still preparing food.</p>	<p>16) 159</p>
	<p>17) 21</p>
	<p>18) 858</p>