



NAN HUA PRIMARY SCHOOL
CONTINUAL ASSESSMENT 1 – 2009
PRIMARY 5

MATHEMATICS

Paper 1

Section A: 15 Multiple Choice Questions (20 marks)

Section B: 15 Short Answer Questions (20 marks)

Total Time for Paper 1: 50 minutes

INSTRUCTION TO CANDIDATES

1. Write your name and index number in the space provided.
2. Do not turn over the page until you are told to do so.
3. Follow all instructions carefully.
4. Answer all questions.
5. Shade your answers in the Optical Answer Sheet (OAS) provided for Questions 1-15.
6. You are not allowed to use calculator for Paper 1.

Marks Obtained

Paper 1	Booklet A		/ 40
	Booklet B		
Paper 2			/ 60
Total			/ 100

Name : _____ ()

Class : 5 _____

Date : 10 March 2009

Parent's Signature : _____

Section A (20 marks)

Questions 1 to 10 carry 1 mark each. Questions 11 to 15 carry 2 marks each. For each question, four options are given. One of them is the correct answer. Mark your choice (1, 2, 3 or 4). Shade the oval (1, 2, 3 or 4) on the Optical Answer Sheet.

1. 69 905 when rounded off to the nearest thousand is _____.

(1) 69 000

(2) 69 900

(3) 70 000

(4) 70 905

2. $240 \cancel{000} + 1 \cancel{000} = 24 \times \boxed{}$

What is the missing number in the box?

(1) 10

(2) 100

(3) 1 000

(4) 10 000

3. 48 926, 48 946, 48 966, 48 986 , _____, 49 026.

Study the pattern shown above and fill in the missing number?

(1) 48 006

(2) 48 996

(3) 49 006

(4) 49 016

4. The digit "5" in 905 328 has a value of _____.

- (1) 5×100
- (2) $5 \times 1\,000$
- (3) $5 \times 10\,000$
- (4) $5 \times 100\,000$

5. A number is 110 000 when rounded off to the nearest thousand.

Which of the following **cannot** be the number?

- (1) 109 590
- (2) 109 940
- (3) 110 410
- (4) 110 980

6. In 45.67, the digit "6" stands for _____.

- (1) 6 hundredths
- (2) 6 tenths
- (3) 6 ones
- (4) 6 tens

7. $200 \times 75 = 25 \times \boxed{} \times 4 \times 3$

What is the missing value in the box?

- (1) 12
- (2) 50
- (3) 300
- (4) 15 000

8. The length of a rectangle is thrice its breadth. If its perimeter is 120 cm, what is its breadth?

- (1) 15 cm
- (2) 20 cm
- (3) 30 cm
- (4) 40 cm

9. A jug has a capacity of 4 l. It contains $2\frac{3}{4}$ l of water.

How much water is needed to fill the jug completely?

- (1) $\frac{1}{4}$ l
- (2) $1\frac{1}{4}$ l
- (3) 4 l
- (4) $6\frac{3}{4}$ l

10. $63 + 81 = \frac{\boxed{}}{27}$

What is the missing value in the box?

- (1) 7
- (2) 18
- (3) 3
- (4) 21

11. Dorothy ate $\frac{1}{3}$ of a cake. Her friend ate $\frac{1}{6}$ of the same cake.

What fraction of the cake is left?

(1) $\frac{2}{9}$

(2) $\frac{1}{3}$

(3) $\frac{1}{2}$

(4) $\frac{1}{9}$

12. Part of the table below was accidentally torn off. The table below shows the number of students from class 5C scoring within various mark ranges in a Mathematics test.

Mark range	Number of students
91 - 100	5
81 - 90	9
71 - 80	
61 - 70	
51 - 60	

35 students scored above 70 marks. How many students scored in the mark range 71 - 80?

- (1) 14
(2) 21
(3) 26
(4) 30

13. What is the value of $72 - (20 + 28) + 4$?

- (1) 6
- (2) 20
- (3) 59
- (4) 60

14. The graph below shows the temperature of water in a Science experiment over a period of time.

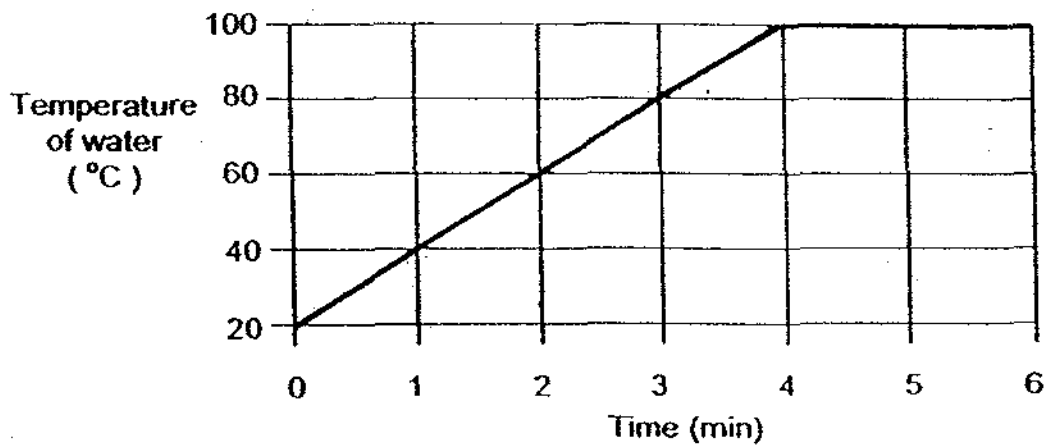

The temperature of the water after 1 minute is 40°C . How much longer will it take for it to reach 80°C ?

- (1) 1 min
- (2) 2 min
- (3) 3 min
- (4) 4 min

15. The figure is made up of four identical squares each of side 3 cm placed together as shown below. What is the perimeter of the figure?

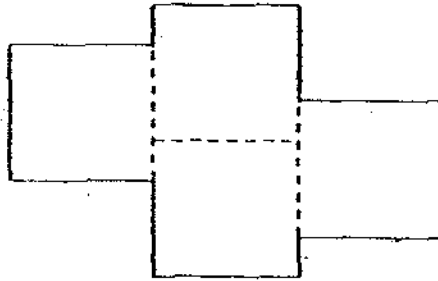

- (1) 24 cm
- (2) 30 cm
- (3) 33 cm
- (4) 48 cm

Section B (20 marks)

Do not
write in
space

Questions 16 to 25 carry 1 mark each. Write your answers in the spaces provided. For questions which require units, give your answers in the units stated.

[10 marks]

16. Express 5 306 048 in words.

Ans : _____

17. Find the sum of all the factors of 16.

Ans : _____

18. What is the quotient when $85\overset{\text{>}}{\underset{\text{^}}{2}}$ divided by 8?

Ans : _____

19. What is the smallest possible number which will give a remainder of 3 when divided by either 12 or 15?

Ans : _____

20. Eight pupils lined up in a row and spaced out equally. The distance between the second and fifth pupil was 6 metres. What was the distance between the third and last pupil?

Ans : _____ m

21. Write the fraction represented by the letter A in its simplest form.

Do not write in this space

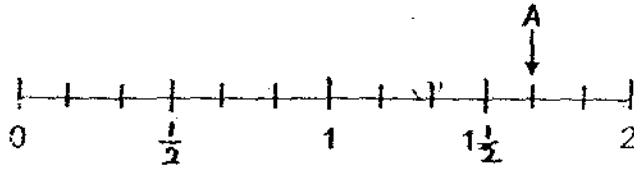

Ans : _____

22. Find the area of the shaded figure.

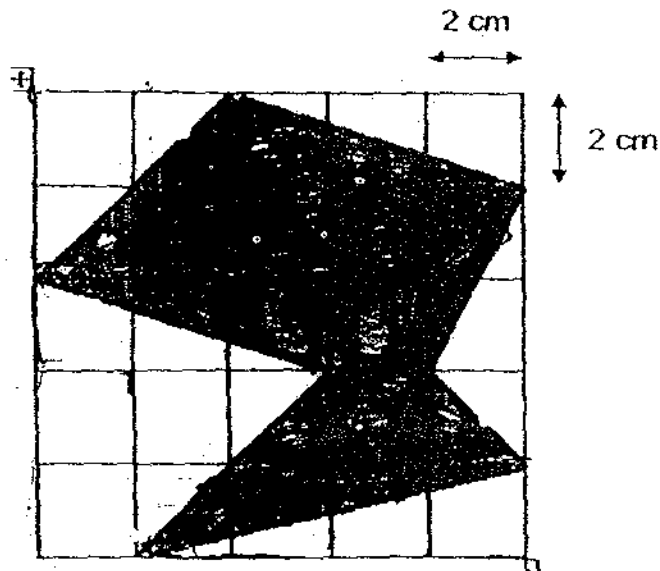

Ans : _____ cm²

23. Express 2 h 50 min in minutes.

Ans : _____ min

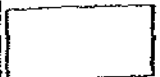

24. Shade two more squares to complete the figure which has the dotted line AB as a line of symmetry.

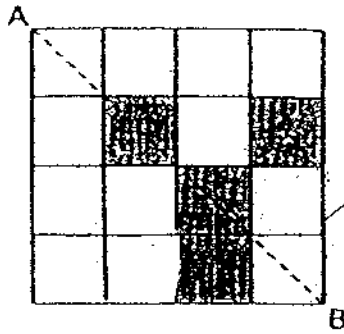

25. The length of a rectangle is three times its breadth. If its perimeter is 64 cm, find its area.

Ans : _____ cm²

Questions 26 to 30 carry 2 marks each. Show your working clearly in the space provided for each question and write your answers in the spaces provided. For each questions which require units, give your answers in the units stated.

[10 marks]

Do not write in this space

26. A company needs to hire buses to send 1 625 workers for an excursion to Botanic Gardens. Each bus can take only 43 people. What is the least number of buses that the company needs to hire?

Ans : _____

27. At a certain bus stop A, 9 passengers alighted from a bus. At bus stop B, 5 passengers alighted and 2 passengers boarded the same bus. There are 29 passengers in the bus now. How many passengers were there in the bus at first?

Ans : _____



28. The perimeter of this rectangular field is 700 m. It is subdivided into six identical rectangular enclosures as shown.

Do not
write in
space



What is the length of each of the smaller rectangular enclosures?

Ans : _____ m

Do not
write in
space

29. Jane spent 4 days making paper dolls for her friends. Each day, she managed to make 2 paper dolls more than the day before. She made a total of 24 paper dolls. How many paper dolls did she make on the last day?

Ans : _____

30. The figure below is made up of a square and a rectangle. Find the perimeter of the figure.

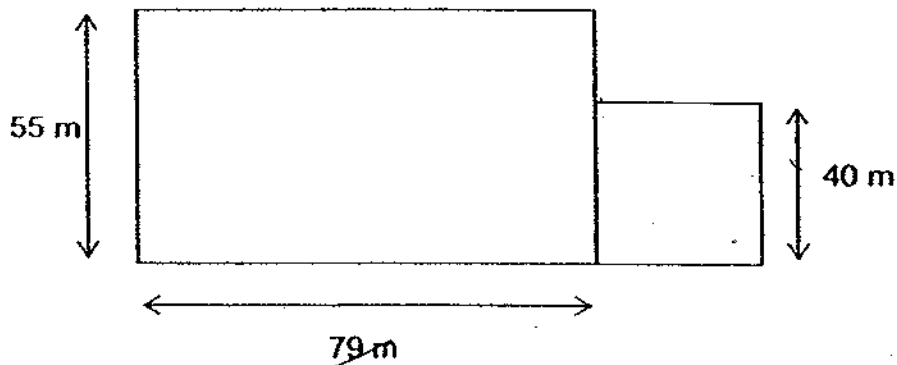

Ans : _____ m

END OF PAPER



**NAN HUA PRIMARY SCHOOL
CONTINUAL ASSESSMENT 1 – 2009
PRIMARY 5**

MATHEMATICS

Paper 2

Total Time for Paper 2: 1 hour 40 minutes

5 Short Answer Questions (10 marks)

13 Structured / Long Answer Questions (50 marks)

INSTRUCTION TO CANDIDATES

- 1. Write your name and index number in the space provided.**
- 2. Do not turn over the page until you are told to do so.**
- 3. Follow all instructions carefully**
- 4. Answer all questions and show your workings clearly.**
- 5. You are allowed to use a calculator.**

Marks Obtained

Total		/ 60
--------------	--	-------------

Name : _____ ()

Class : 5 _____

Date : 10 March 2008

Parent's Signature : _____

Questions 1 to 5 carry 2 marks each. Show your working clearly in the space provided for each question and write your answers in the spaces provided. For questions which require units, give your answers in the units stated. [10 marks]

Do not write
in this space

1. The sum of two numbers, A and B is 2 454. If the value of A is five times the value of B, find the value of A.

Answer: _____

2. Jane was given $\frac{2}{7}$ of a cheese cake and Mary was given $\frac{3}{5}$ of the same cake. What fraction of the cake was left?

Answer: _____

3. Tim wants to purchase a new car which costs \$105 000. He first needs to pay a downpayment of \$10 500. The remaining amount will be paid in monthly instalment over 7 years. How much is each monthly instalment?

Do not write
in this space

Answer: \$ _____

4. Roland managed to complete a jigsaw puzzle in $3\frac{2}{5}$ h. How many minutes did he take to complete the puzzle?

Answer: _____ min

5. The four shaded corners of the square below consist of identical triangles. Find the area of the unshaded part.

Do not write
in this space

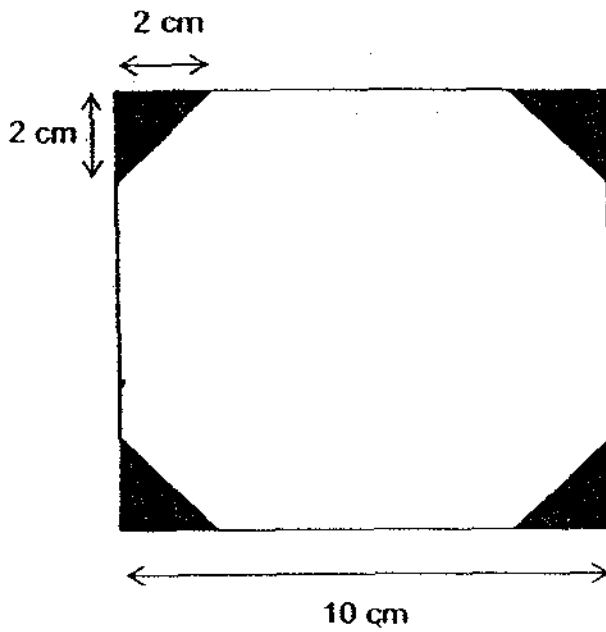

Answer: _____ cm^2

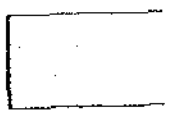

For questions 6 to 18, show your working clearly in the space provided for each question and write your answers in the spaces provided.

The number of marks available is shown in the brackets [] at the end of each question or part question. [50 marks]

Do not write
in this space

6. Primary 5C sold 3 times as many funfair coupons as Primary 5D on Monday. On Tuesday, Primary 5C sold another 75 coupons while Primary 5D sold another 127 coupons. The total number of coupons sold by each class then became the same. Find the number of funfair coupons sold by Primary 5C on Monday.

Answer: _____ [3]

7. Angeline and Joanne received \$967 from their father. Angeline received more money than Joanne. When Angeline bought a pair of earrings for \$42 and Joanne received an additional \$85 from her mother, their amount of money became the same. How much money did Joanne receive from her father?

Answer: _____ [3]

8. Robin jogged $3\frac{1}{4}$ km. His sister, Tammy, jogged $\frac{2}{5}$ km more. What is the total distance covered by them. Give your answer in metres.

Do not write
in this space

Answer: _____ [3]

9. Torres sold 18 soccer balls on Saturday. He sold $\frac{3}{7}$ of the remainder on Sunday. If he still had 100 soccer balls left to be sold on Monday, how many soccer balls did he have at first?

Answer: _____ [3]

10. Melissa visited a farm where she saw some ducks and goats. There were a total of 65 ducks and goats. She then counted the legs of the animals and found that there were 196 legs. How many ducks were there in the farm?

Do not write
in this space

Answer: _____ [3]

11. Molly scored a total of 190 marks for Mathematics and Science. She scored a total of 179 marks for her Science and English. She had 6 more marks for Science than Mathematics. How many marks did she get for English?

Answer: _____ [4]

12. In the figure, the side of the shaded square is $\frac{1}{3}$ that of the side of the big square. Find the area of the unshaded part of the figure.

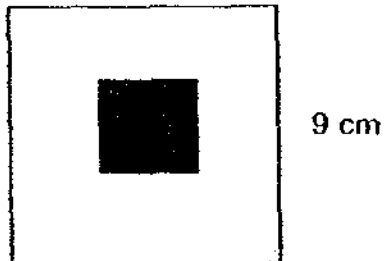

Do not write
in this space

Answer: _____ [4]

13. $\frac{3}{8}$ of Christie's money is equal to $\frac{1}{4}$ of Jenny's money. After each of them spent \$40, Jenny had \$64 more than Christie. How much money does Jenny have left after spending the money?

Do not write
in this space

Answer: _____ [4]

14. Keith and ^{Diana} ~~Danny~~ read a total of 30 books in January. In February, Keith read 9 books fewer than ^{Diana} ~~Danny~~ who had read thrice as many as he did in January. If both of them read a total of 45 books in February, how many books did Keith read in the 2 months?

Do not write
this space

Answer: _____ [4]

15. The figure ABCD is made up of 4 identical rectangles. It has a perimeter of 56 cm. What is the area of ABCD?

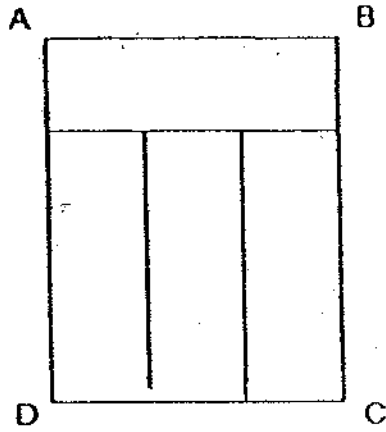

Do not write
this space

Answer: _____ [4]



16. Penny has some 10-cent coins and 50-cent coins. The coins add up to \$10.70. If there are five more 10-cent coins than 50-cent coins, how many 10-cent coins are there?

Do not write
in this space

Answer: _____ [5]

17. Tap A can fill a tank in 3 minutes. Tap B can fill a similar tank in 5 minutes.

(a) What fraction of the tank is filled when Tap A is turned on for 2 minutes?

(b) What fraction of the tank is filled after one minute when both taps are turned on at the same time?

Do not write
in this space

Answer: (a) _____ [2]

(b) _____ [3]

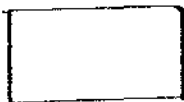

18. Study the Pascal's Triangle shown below and answer the questions that follow.

1 st row				1								
2 nd row			1		1							
3 rd row			1		2		1					
4 th row		1		3		3		1				
5 th row		1		4		6		4		1		
6 th row		1								1		[2]

- (a) Complete the 6th row of the Pascal's Triangle by filling in the blanks above.
- (b) Find the sum of the numbers in the 6th row.
- (c) Find the sum of the numbers in the 10th row.

Answer: (b) _____ [1]

(c) _____ [2]

Do not write
in this space



END OF PAPER

ANSWER SHEET

EXAM PAPER 2009

SCHOOL : NAN HUA PRIMARY
SUBJECT : PRIMARY 5 MATHEMATICS

TERM : CA1

Q1	Q2	Q3	Q4	Q5	Q6	Q7	Q8	Q9	Q10	Q11	Q12	Q13	Q14	Q15
3	1	3	2	4	2	2	1	2	4	3	2	4	2	2

16) five million, three hundred and six thousand and forty-eight.

17)31 18)106 19)63 20)10m 21) $1\frac{2}{3}$ 22)50cm²

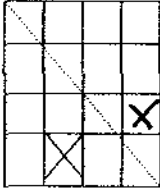
23)170 min 24)  25)192cm² 26)38 27)41 passengers

28)100m 29)9 30)348m

paper 2

<p>1) $2454 \div 6 = 409$ $409 \times 5 = 2045$ The value of A is 2045</p>	<p>2) $2\frac{7}{7} + 3\frac{3}{5} = 31\frac{31}{35}$ $35\frac{35}{35} - 31\frac{31}{35} = 4\frac{4}{35}$ The fraction is $4\frac{4}{35}$</p>
<p>3) $105000 - 10500 = 94500$ $7 \times 12 = 84$ $94500 \div 84 = \\$1125$ Each monthly instalment is \$1125</p>	<p>4) $3\frac{2}{5} \times 60\frac{0}{1} = 204$ He took 204 minutes</p>
<p>5) $2 \times 2 = 4$ $4 \times 2 = 8$ $10 \times 10 = 100$ $100 - 8 = 92$ The area is 92cm²</p>	<p>6) 2 units $\rightarrow 127 - 75 = 52$ 1 unit $\rightarrow 52 \div 2 = 26$ 3 units $\rightarrow 26 \times 3 = 78$ 5C sold 78 coupons on Monday</p>

<p>7) $967 - (42 + 85) = 840$ $840 \div 2 = 420$ She received \$420 from her father.</p>	<p>8) $3\frac{1}{4} \times 2\frac{1}{1} = 6\frac{1}{2} + \frac{2}{5} = 6\frac{9}{10}$ $6\frac{1}{2} \times 1000 = 6900$ The total distance covered is 6900m</p>
<p>9) $100 \div 4 = 25$ $25 \times 7 = 175$ $175 + 18 = 193$ He had 193 soccer balls at first</p>	<p>10) There were 32 ducks</p>
<p>11) $190 - 6 = 184$ $184 \div 2 = 92$ $92 + 6 = 98$ $179 - 98 = 81$ She scored 81 marks for English</p>	<p>12) $9 \div 3 = 3$ $3 \times 3 = 9$ $9 \times 9 = 81$ $81 - 9 = 72$ The area is 72cm²</p>
<p>13) \$152</p>	<p>14) $45 - 9 = 36$ $36 \div 2 = 18$ $18 + 9 = 27$ $27 \div 3 = 9$ $30 - 9 = 21$ $21 + 18 = 39$ Keith read 39 books</p>
<p>15) 192cm²</p>	<p>16) 22 10¢ coins</p>
<p>17) a) $\frac{2}{3}$ b) $\frac{8}{15}$</p>	<p>18) a) 5, 10, 10, 5 b) 32 c) 512</p>