



AI TONG SCHOOL

2009

SEMESTRAL ASSESSMENT 2

PRIMARY 5

MATHEMATICS Paper 1 (Booklet A and B)

DURATION : 50 min

DATE : 3 November 2009

INSTRUCTIONS

Do not open the booklet until you are told to do so.

Follow all instructions.

Answer all questions.

You are not allowed to use a calculator.

Name : _____ ()

Class : Primary 5 _____

Marks:

Paper 1	40
Paper 2	60
Total	100

Parent's Signature :	_____
Date :	_____

Paper 1

Booklet A

Questions 1 to 10 carry 1 mark each. Questions 11 to 15 carry 2 marks each.

For each question, four options are given. One of them is the correct answer.

Make your choice (1, 2, 3 or 4). Shade the oval (1, 2, 3 or 4) on the Optical Answer Sheet. (20 marks)

1 Seven million and seventy-seven thousand in numerals is _____.

- (1) 7 000 770
- (2) 7 007 700
- (3) 7 077 000
- (4) 7 770 000

2 A machine can wrap 58 sweets in 1 minute. How many sweets can it wrap in 1 hour?

- (1) 348
- (2) 3480
- (3) 34 800
- (4) 348 000

3 Which of the following is the largest fraction?

- (1) $\frac{2}{3}$
- (2) $\frac{5}{6}$
- (3) $\frac{3}{4}$
- (4) $\frac{11}{12}$

4 Find the value of $\frac{7}{8} \div 4$.

- (1) $\frac{7}{32}$
- (2) $\frac{2}{7}$
- (3) $3\frac{1}{2}$
- (4) $4\frac{4}{7}$

5 The ratio of Glen's height to Peter's height is 5 : 4. Peter is 140 cm tall. What is Glen's height?

- (1) 112 cm
- (2) 135 cm
- (3) 165 cm
- (4) 175 cm

6 Express 10 m 7 cm in metres.

- (1) 1.07 m
- (2) 10.07 m
- (3) 10.7 m
- (4) 100.7 m

7 There were 50 pupils at a choir selection. 35 pupils were selected. What percentage of the pupils were not selected?

- (1) 20%
- (2) 30%
- (3) 40%
- (4) 70%

8 What is the average of all the even numbers from 1 to 10?

- (1) 5.5
- (2) 5
- (3) 3
- (4) 6

9 The figure below is not drawn to scale. Find the value of x .

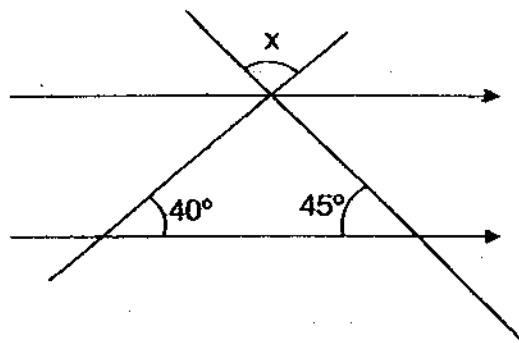

- (1) 85°
- (2) 90°
- (3) 95°
- (4) 100°

- 10 The diagram below is not drawn to scale. ABD is an isosceles triangle and ABC is a straight line. Find $\angle DBC$.

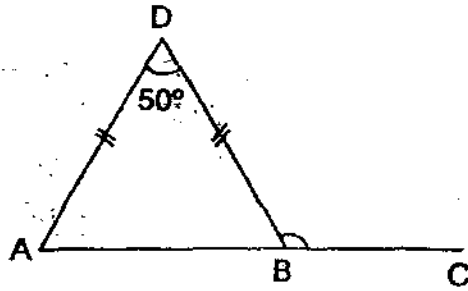

- (1) 100°
(2) 115°
(3) 130°
(4) 140°
- 11 At a concert, 60 tickets were sold at the usual price and the remaining 40 tickets were sold at half the usual price. The total amount of money collected was \$720. What was the usual price of a ticket?
- (1) \$4.50
(2) \$7.20
(3) \$9.00
(4) \$12.00
- 12 At a school prize-giving ceremony, there were 60 more boys than girls. $\frac{4}{11}$ of the pupils were girls. How many boys were there?
- (1) 220
(2) 140
(3) 80
(4) 60
- 13 Leonard and Max shared some game cards in the ratio of 7 : 3. When Leonard gave Max 16 game cards, he found that they each had the same number of cards. How many game cards did Max have at first?
- (1) 56
(2) 28
(3) 24
(4) 12

14 At a sale, a refrigerator was sold at a discount of 15%. The price of the refrigerator was \$1700 after the discount. What was the original price of the refrigerator?

- (1) \$1445
- (2) \$1685
- (3) \$1955
- (4) \$2000

15 Mustafa wants to fill up his rectangular water tank measuring 20 cm by 30 cm by 40 cm to its brim. He turns on 2 taps, Tap A and Tap B, at the same time. 4 litres of water flow out from Tap A per minute and 2 litres of water flow out from Tap B per minute. How long does it take to fill up the whole tank?

- (1) 24 min
- (2) 12 min
- (3) 6 min
- (4) 4 min

Booklet B

Questions 16 to 25 carry 1 mark each. Write your answers in the spaces provided. For questions which require units, give your answers in the units stated. (10 marks)

16 What is the value of $50 + (80 + 4) \times 2$?

Ans: _____

17 Using all the digits below, form the smallest five-digit odd number.

2, 8, 0, 5, 1

Ans: _____

18 When 396 900 is divided by 700, what is the digit in the **tens** place?

Ans: _____

19 There are 210 books in the class library. Two out of every three books are English books. How many English books are there?

Ans: _____

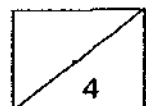

- 20 A string was cut into 3 pieces in the ratio 3 : 1 : 8. What was the shortest length of the string if the longest piece is 24 cm?

Ans: _____ cm

- 21 There are 40 pupils in a class. 24 of them are boys and the rest are girls. What percentage of the pupils in the class are boys?

Ans: _____ %

- 22 The table shows the postage for letters and small parcels to Australia.

Mass step not over	Postage
20 g	50¢
50 g	70¢
100 g	\$1.00
per additional step of 100 g	\$1.00

How much did Andrew pay for sending a parcel of mass 370g to Australia?

Ans: \$ _____

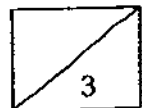

- 23 The average mass of a group of 4 boys is 35 kg. A fifth boy with a mass of 40 kg joins the group. What is the average mass of the group now?

Ans: _____ kg

- 24 The figure is not drawn to scale. ABC is an equilateral triangle and BCD is a straight line. Find the value of $\angle BAD$.

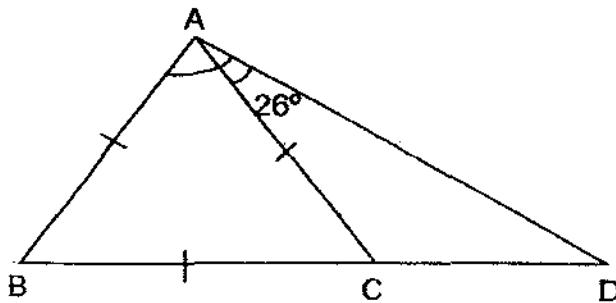

Ans: _____

- 25 The trapezium is not drawn to scale. Find the value of $\angle a$.

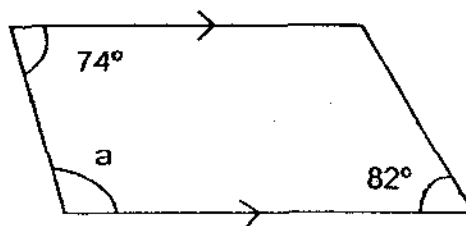

Ans: _____

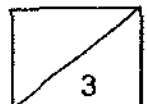

Questions 26 to 30 carry 2 marks each. Show your working clearly in the space provided for each question and write your answers in the spaces provided. For questions which require units, give your answers in the units stated. (10 marks)

- 26 Susan had \$60. She spent $\frac{5}{12}$ of her money on a bag and $\frac{2}{5}$ of the remainder on a book. How much did she spend on the book?

Ans: \$ _____

- 27 A cubic tank with sides 20 cm contains 3.25 litres of water. How much more water is needed to fill the tank completely? Give your answer in litres. (1 l = 1000 cm³)

Ans: _____ l

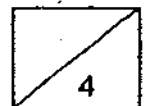

- 28 A bucket filled with sand has a mass of 16 kg. When it is filled with water, the mass is 6 kg. The mass of the sand is thrice that of the water. Find the mass of the bucket in kilograms.

Ans: _____ kg

- 29 In the figure, the length of the smaller square is 14 cm and the length of the bigger square is 17 cm. Find the shaded area.

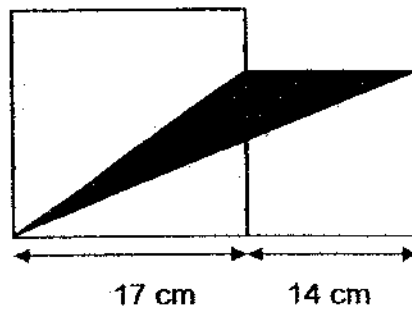

Ans: _____ cm²

- 30 There were 800 people in an auditorium. During the interval, 25% of the audience left the auditorium. How many people were left in the auditorium?

Ans: _____

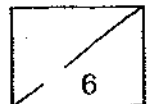

Questions 1 to 5 carry 2 marks each. Show your working clearly in the space provided for each question and write your answers in the spaces provided. For questions which require units, give your answers in the units stated. (10 marks)

- 1 Mdm Ang bought 3 kg of prawns and 4 crabs for \$60. Each crab cost \$7.50, how much is 1 kg of prawns?

Ans: \$ _____

- 2 20% of the fruits in a shop are apples and the rest are oranges. If there are 60 apples, how many oranges are there?

Ans: _____

- 3 The average height of 4 boys is 150 cm. The average height of the first 3 boys is 152 cm. What is the height of the fourth boy?

Ans: _____ cm

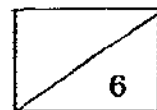



AI TONG SCHOOL

2009

SEMESTRAL ASSESSMENT 2

PRIMARY 5

MATHEMATICS

Paper 2

DURATION : 1 h 40 min

DATE : 3 November 2009

INSTRUCTIONS

Do not open the booklet until you are told to do so.

Follow all instructions.

Answer all questions.

You are allowed to use a calculator.

Name : _____ ()

Class : Primary 5 _____

Marks: Paper 2

	60
--	----

Parent's Signature : _____

Date : _____

- 4 Draw a trapezium ABCD in which $AB \parallel CD$, $AB = 5$ cm, $CD = 8$ cm, $AD = 4$ cm and $\angle ADC = 80^\circ$. Label the trapezium clearly.

- 5 The rhombus below is not drawn to scale. Find the value of $\angle x$.

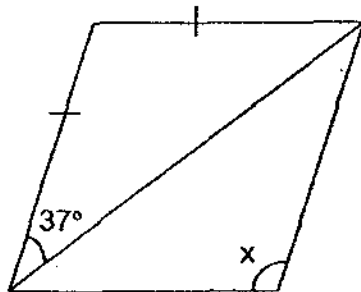

Ans: _____

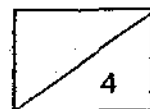

For questions 6 to 18, show your working clearly in the space provided for each question and write the answers in the spaces provided.
 The number of marks available is shown in the brackets [] at the end of each question or part-question. (50 marks)

- 6 The total mass of 3 friends, Amy, Ben and Cindy, is 195 kg. The mass of Amy is 7 kg less than Ben, and Ben is 14 kg more than Cindy. Find the mass of Cindy.

Ans: _____ [3]

- 7 The figure below is not drawn to scale. Triangle ABE is an equilateral triangle. Triangle ACD is an isosceles triangle. $\angle CAD$ is $\frac{1}{6}$ of $\angle BAE$. Find the value of $\angle y$.

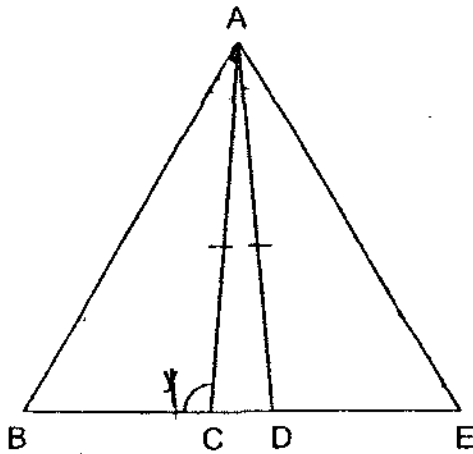

Ans: _____ [3]

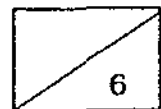

- 8 Dan had some marbles. He gave away 225 marbles to Eve and $\frac{2}{9}$ of the remainder to Freddy. He found that he had $\frac{1}{2}$ of his original number of marbles left. How many marbles did Dan have at first?

Ans: _____ [3]

- 9 Sally's salary is 30% more than Janet's. If their total salary is \$5290, what is Sally's salary?

Ans: _____ [3]

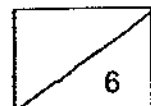

- 10 The figure below not drawn to scale shows the rectangle WXYZ overlapping with another rectangle ABCD. Find the value of $\angle h$.

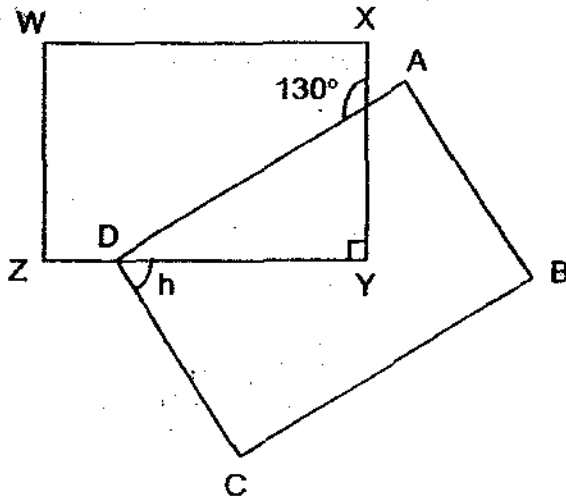

Ans: _____ [3]

- 11 A book has 400 pages numbered 1, 2, 3 and so on. How many times does the digit 2 appear in all the page numbers?

Ans: _____ [3]

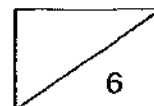

- 12 Siti had some money. She gave some money to Kelly and Lindy and saved the rest. The ratio of her savings to the amount she gave away was 5 : 8. The ratio of Kelly's money to Lindy's money was 5 : 3 at first. After Kelly's money increased by \$128 and Lindy's money decreased by \$128, the ratio of Kelly's money to Lindy's money became 3 : 1. How much money did Siti save?

Ans: _____ [4]

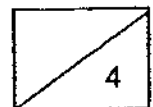

- 13 Henry drew a triangle and split it into 3 parts as shown in the figure below. He shaded 2 parts and left 1 part unshaded. What is the area of the shaded portion of the triangle?

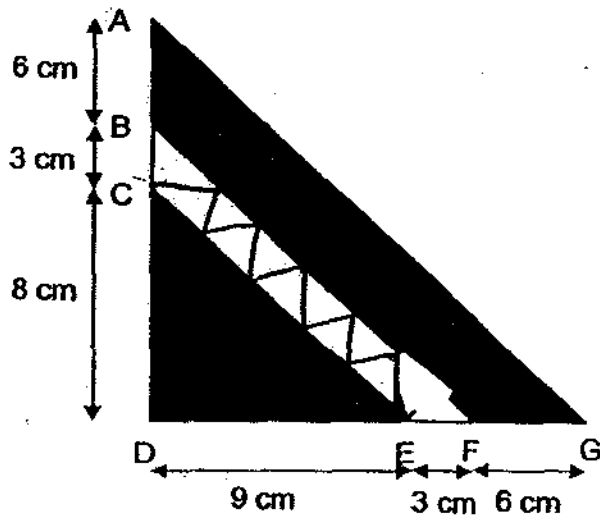

Ans: _____ [4]

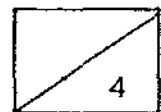

- 14 50 books of equal thickness are stacked on top of one another. The stack of books is 225 cm high. 15 books are removed from the stack and 22 magazines are stacked on top of the remaining books. What is the thickness of each magazine if the new height is 192.7 cm?

Ans: _____ [4]

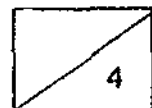

- 15 Jeanny spent $\frac{3}{7}$ of her allowance on a bag and $\frac{1}{5}$ of the remainder on transport. She spent the rest on a book and a CD in the ratio of 1 : 3. The CD cost \$12 more than the book. What was the cost of the bag?

Ans: _____ [5]

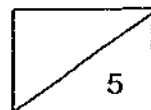

- 16 The ratio of the number of ten-cent to twenty-cent stamps in an album was 3 : 4. 50 ten-cent stamps were taken out, exchanged for twenty-cent stamps of the same value and put back into the album. The ratio then became 1 : 5. Find the total value of all the stamps in the album at first.

Ans: _____ [5]

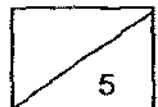

- 17 A seamstress had some white and some black buttons. 60% of the buttons were white. He bought another 120 buttons. Now, the percentage of white buttons became only 40% of the total. How many white buttons did he have at first?

Ans: _____ [5]

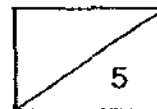

- 18 Dexter is given \$7.50 more pocket money than Dee Dee each week. Each of them spends \$9.50 every week and saves the rest. When Dexter saves \$55.50, Dee Dee saves \$18. How much pocket money does Dexter receive each week?

Ans: _____ [5]

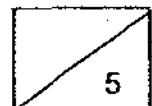

ANSWER SHEET

EXAM PAPER 2009

**SCHOOL : AITONG PRIMARY
SUBJECT : PRIMARY 5 MATHEMATICS**

TERM : SA2

Q1	Q2	Q3	Q4	Q5	Q6	Q7	Q8	Q9	Q10	Q11	Q12	Q13	Q14	Q15
3	2	4	1	4	2	2	4	3	2	3	2	3	4	4

- 16)90 17)10285 18)6 19)140 20)3cm
 21)60% 22)\$4 23)36kg 24)86° 25)106°
 26)\$14 27)4.75L 28)1 kg 29)98cm² 30)600 people

Paper 2

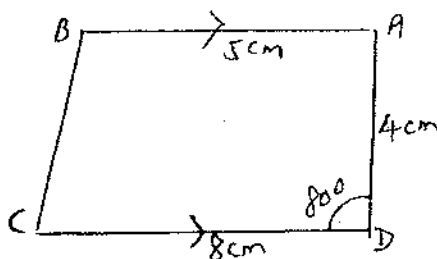
1) $7.5 \times 4 = 30$ $60 - 30 = 30$ $30 \div 3 = \$10$	2) $1u \rightarrow 60$ $4u \rightarrow 60 \times 4 = 240$ oranges.
3) 144cm	4) 
5) 106°	6) $7 \times 3 = 21$ $195 - 21 = 174$ $174 \div 5 = 58\text{kg}$
7) $60 \div 6 = 10$ $180 - 10 = 170$ $170 \div 2 = 85$ $180 - 85 = 95$	8) $5u \rightarrow 225$ $1u \rightarrow 225 \div 5 = 45$ $45 \times 9 = 405$ $405 + 225 = 630$ marbles

<p>9) Sally : Janet $130 : 100$ $= 13 : 10$ $10 + 13 = 23$ 23 units \rightarrow 5290 1 unit \rightarrow $5290 \div 23 = 230$ 13 units \rightarrow $230 \times 13 = \\$2990$</p>	<p>10) $180 - 130 = 50$ $50 + 90 = 140$ $180 - 140 = 40$ $90 - 40 = 50^\circ$</p>
<p>11) 180 times</p>	<p>12) \$640</p>
<p>13) $\frac{1}{2} \times 17 \times 18 = 153$ $\frac{1}{2} \times 12 \times 11 = 66$ $153 - 66 = 87$ $66 - \frac{1}{2} \times 8 \times 9 = 30$ $36 + 87 = 123 \text{cm}^2$</p>	<p>14) $225 \div 50 = 4.5$ $50 - 15 = 35$ $35 \times 4.5 = 157.5$ $192.7 - 157.5 = 35.2$ $35.2 \div 22 = 1.6$</p>
<p>15) $3 - 1 = 2$ $12 \div 2 = 6$ $6 \times 4 = 24$ $24 \div 16 = 1.5$ $1.5 \times 20 = 30$ $30 \div 4 = 7.5$ $7.5 \times 3 = \\$22.5$</p>	<p>16) $50 \div 2 = 25$ $25 \times 4 = 100$ $25 \times 3 = 75$ $100 \times 20 = 2000$ $75 \times 10 = 750$ $750 + 20 = \\$27.50$</p>
<p>17) 72 white buttons</p>	<p>18) $55.5 - 18 = 37.5$ $37.5 \div 7.5 = 5$ $9.5 \times 5 = 47.5$ $47.5 + 55.5 = 103$ $103 \div 5 = \\$20.60$</p>