

Name : _____

Date: _____

Class : Primary 5

SINGAPORE CHINESE GIRLS' SCHOOL
SECOND SEMESTRAL EXAMINATION 2009

PRIMARY 5
MATHEMATICS
PAPER 1
Booklet A

	Mark	Max Mark
Booklet A		20

Parent's Signature

15 Questions

20 Marks

Total Time For Booklets A and B : 50 min

DO NOT OPEN THIS BOOKLET UNTIL YOU ARE TOLD TO DO SO.

FOLLOW ALL INSTRUCTIONS CAREFULLY.

ANSWER ALL QUESTIONS.

Booklet A

Questions 1 to 10 carry 1 mark each. Questions 11 to 15 carry 2 marks each.
For each question, four options are given. One of them is the correct answer.
Make your choice (1, 2, 3 or 4). Shade the correct oval (1, 2, 3 or 4) on the Optical Answer Sheet. **(20 marks)**

1 In 9 401 687, the value of the digit '4' is _____.

- ~~(1)~~ 4×1000
- ~~(2)~~ $4 \times 10\,000$
- ~~(3)~~ $4 \times 100\,000$
- ~~(4)~~ $4 \times 1\,000\,000$

2 $5\text{ L } 5\text{ mL} =$ _____

- (1) 0.55 L
- (2) 5.5 L
- (3) 5.05 L
- (4) 5.005 L

3 How many sixths are there in $3\frac{1}{3}$?

- (1) 8
- (2) 2
- (3) 10
- (4) 20

4 Raju has 56 marbles. 24 of the marbles are yellow and the rest are blue. Find the ratio of the number of yellow marbles to the number of blue marbles.

- (1) $2 : 3$
- (2) $3 : 4$
- (3) $4 : 3$
- (4) $4 : 7$

5 The following fractions are arranged in ascending order.

$$\frac{4}{12}, \frac{1}{3}, \boxed{}, \frac{1}{2}$$

Which one of the following fractions is most likely to be the missing fraction in the box?

~~(1)~~ $\frac{1}{6}$

~~(2)~~ $\frac{1}{4}$

~~(3)~~ $\frac{2}{3}$

~~(4)~~ $\frac{5}{12}$

6 Express 2.5% as a decimal.

(1) 0.025

(2) 0.25

(3) 2.05

(4) 2.5

7 Given that $11.5 \times 6 = 69$. If $1.15 \times \boxed{} = 69$, what is the missing number in the $\boxed{}$?

(1) 0.06

(2) 0.6

(3) 60

(4) 600

8 Which one of the following statements about a trapezium is incorrect?

~~(1)~~ Its sum of angles is 360° .

~~(2)~~ It has 1 pair of parallel lines.

~~(3)~~ It can be formed by 2 triangles.

~~(4)~~ One of its angles must be a right angle.

9 What is the value of $72 + (28 - 4 \times 5) + 6 + 8 \times 4$?

- (1) 41
- (2) 47
- (3) 65
- (4) 92

10 The figure shows a square that is made up of four parts, P, Q, R and S.

Q is a square and is $\frac{1}{4}$ of the figure. Which of the following two parts will add up to form $\frac{5}{8}$ of the figure?

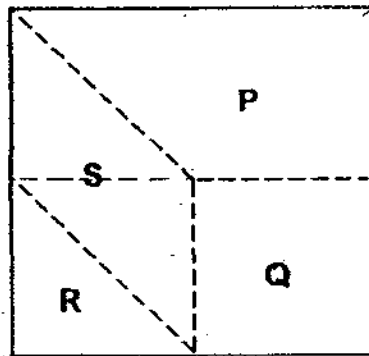

- (1) R and Q
- (2) R and P
- (3) S and Q
- (4) S and P

11 A tree was 5.4 m tall 5 years ago. It grows an average height of 25 cm every year. How tall is the tree now?

- (1) 5.65 m
- (2) 6.29 m
- (3) 6.65 m
- (4) 7.9 m

12 Hui Min read $\frac{1}{4}$ of a book on Monday, $\frac{1}{3}$ of the book on Tuesday and $\frac{1}{5}$ of the remaining pages on Wednesday. She read the final 40 pages on Thursday. How many pages were there in the book?

- (1) 60
- (2) 100
- (3) 120
- (4) 150

- 13 Sabrina made a pattern using 4 shapes. The pattern is shown below. Which of the following is the 98th shape of the pattern?



- (1)
- (2)
- (3)
- (4)

- 14 In the following diagram, ABCD is a parallelogram. The ratio of $\angle ABC$ to $\angle BCD$ is 1 : 2. What is the value of $\angle DAB$?

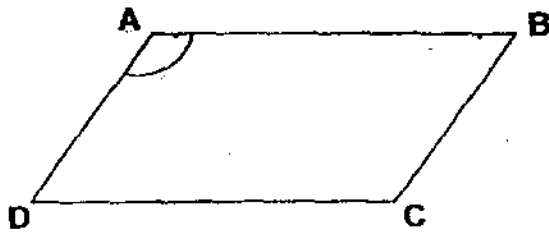

- (1) 30°
 - (2) 60°
 - (3) 120°
 - (4) 150°
- 15 A box can hold 24 markers or 30 pencils. If there are already 12 markers and 9 pencils in the box, how many more pencils can be put into the box?

- (1) 5
- (2) 6
- (3) 15
- (4) 21

Name : _____

Date: _____

Class : Primary 5

SINGAPORE CHINESE GIRLS' SCHOOL
SECOND SEMESTRAL EXAMINATION 2009

PRIMARY 5

MATHEMATICS

PAPER 1

Booklet B

	Mark	Max Mark
Booklet B		20

Parent's Signature

15 Questions

20 Marks

Total Time For Booklets A and B : 50 min

DO NOT OPEN THIS BOOKLET UNTIL YOU ARE TOLD TO DO SO.

FOLLOW ALL INSTRUCTIONS CAREFULLY.

ANSWER ALL QUESTIONS.

Booklet B

Name: _____ () Class: P5 SY/CIG/SE/P

Do not write in this column

Questions 16 to 25 carry 1 mark each. Write your answers in the spaces provided. For questions which require units, give your answers in the units stated. (10 marks)

16 Mr Rahim spent \$79 504 on a car. Round off the price of the car to the nearest thousand.

Ans: \$ _____

17 Find the value of 60% of 3000.

Ans: _____

18 If Devi has 4 times as many apples as Eileen and Eileen has twice as many apples as Farid, what is the ratio of the number of Devi's apples to the number of Eileen's apples to the number of Farid's apples?

Ans: _____

19 $2.073 = 2 + 7 \times \square + 3 \times 0.001$. What is the number in the box?

Ans: _____

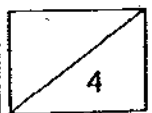

20 4 toothbrushes cost \$7. If Jasmine buys 20 toothbrushes, how much does she have to pay?

Ans: \$ _____

21 Fill in the missing value indicated by the arrow.

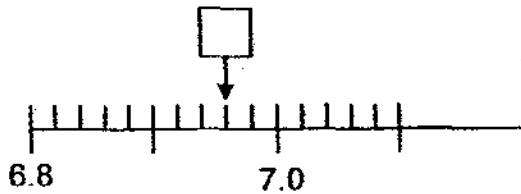

Ans: _____

22 The average of 5 numbers is 14. If the average of 4 of the numbers is 16, What is the 5th number?

Ans: _____

23 The base area of a rectangular tank is 30 cm^2 . If its volume is 270 cm^3 , what is its height?

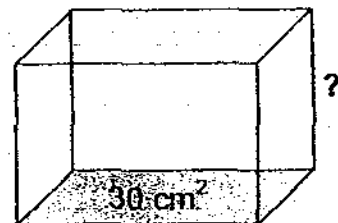

Ans: _____ cm

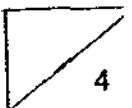

- 24 The figure below is made up of 1-cm cubes. How many more cubes are needed to make a 3-cm cubic solid?

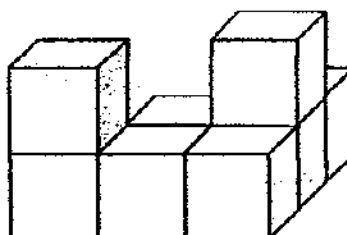

Ans: _____

- 25 $\frac{2}{5}$ of Rod X is joined to $\frac{1}{3}$ of Rod Y as shown below. Express the length of Rod X as a fraction of Rod Y in its simplest form.



Ans: _____

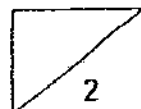

Questions 26 to 30 carry 2 marks each. Show your working clearly in the space for each question and write your answers in the spaces provided. For questions which require units, give your answers in the units stated. (10 marks)

Do not write this column

26 43 is the average of 29, 43, 51 and _____.
What is the value of the missing number?

Ans: _____

27 In the following figure, not drawn to scale, PQRS is a rectangle. VSU is a straight line. Find $\angle PVU$.

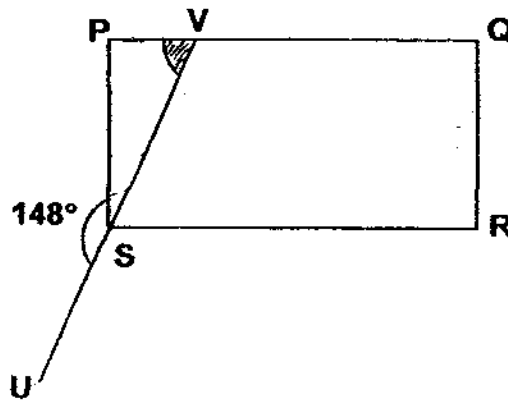

Ans: _____°

28 The following figure shows a square piece of cardboard WXYZ. Four small squares of equal size and a circle, twice the area of each small square, were cut out from the cardboard. What percentage of the cardboard was cut out?

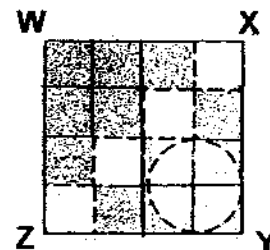

Ans: _____%

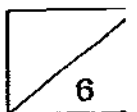

Do not write
this column

- 29 For every dollar that a customer spent at a toy shop, the toy shop owner will contribute \$0.20 to the charity. If he had contributed \$560 to the charity, how much money did his customers spend at his toy shop?

Ans: \$ _____

- 30 The head of a toy dog is 10 cm long. Its tail is as long as its head plus half the length of its body. The body is as long as the head and tail. What is the length of

Ans: _____ cm

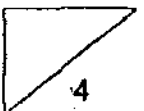

Name : _____ ()

Date: _____

Class : Primary 5

SINGAPORE CHINESE GIRLS' SCHOOL
SECOND SEMESTRAL EXAMINATION 2009
PRIMARY 5
MATHEMATICS
PAPER 2

	Mark	Max Mark
Paper 2		60

Parent's Signature

18 Questions

60 Marks

Total Time For Paper 2 : 1 h 40 min

DO NOT OPEN THIS BOOKLET UNTIL YOU ARE TOLD TO DO SO.

FOLLOW ALL INSTRUCTIONS CAREFULLY.

ANSWER ALL QUESTIONS.

Questions 1 to 5 carry 2 marks each. Show your working clearly in the space below each question and write your answers in the space provided. For questions which require units, give your answers in the units stated. (10 marks)

Do not write in this column

- 1 A duck weighs 3.8 kg. A chicken weighs 365 g less than the duck. What is the total mass of the duck and the chicken?

Ans: _____ kg

- 2 Laura saved \$1.80 in 3 weeks. How much would she save in 20 weeks if she saved the same amount of money each week?

Ans: \$ _____

- 3 If $\frac{2}{5}$ of a number is 76, what is $\frac{7}{10}$ of the number?

Ans: _____

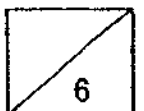

4. 2 sets of teacups and 3 sets of cutlery cost \$184. How much will 6 sets of teacups and 9 sets of cutlery cost?

Do not write in
this column

Ans: \$ _____

5. Paul and James shared a box of candies. Paul ate $\frac{1}{4}$ of the candies. James ate 3 more pieces of candies than Paul. If there were 15 pieces of candies left, how many pieces of candies were there in the box at first?

Ans: _____

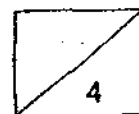

For questions 6 to 18, show your working clearly in the space below each question and write your answers in the spaces provided. The number of marks awarded is shown in brackets [] at the end of each question or part-question. (50 marks)

Do not write
this column

- 6 The usual price of a television set is \$1750. Mr Ong bought it at a discount of 15%. If he pays GST at 7% of the discounted price, how much GST did he pay? (Express your answer to the nearest dollar)

Ans: _____ [3]

- 7 The figure below is not drawn to scale. What is the value of $\angle y$?

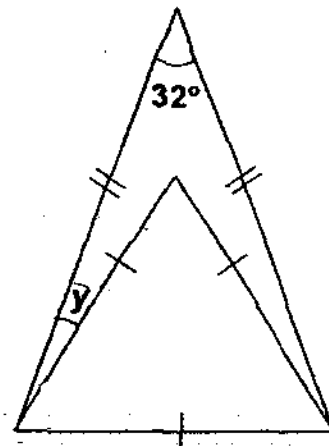

Ans: _____ [3]

6

Do not write in
this column

- 8 A group of boys and 18 girls signed up for a tennis course. On the first lesson, the ratio of the number of girls to the number of boys was 2 : 3. After a few lessons, some boys stopped attending the course and the ratio of the number of girls to the number of remaining boys became 3 : 2. How many boys stopped attending the course?

Ans: _____ [3]

- 9 Mr Chan has a few children. Each of his sons has the same number of brothers as sisters. Each of his daughters has twice as many brothers as sisters. How many children does Mr Chan have?

Ans: _____ [3]

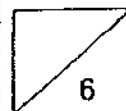

- 10 A group of soldiers were marching on a parade square. There were 4 rows of soldiers with 15 soldiers in each row. As the soldiers marched, they moved to form the perimeter of a square with the same number of soldiers on each side of the square. How many soldiers were there on each side of the square?

Ans: _____ [3]

- 11 A librarian recorded the number of books borrowed by pupils of Primary 5A in the table below.

Number of books borrowed	0	1	2	3	4	5	6
Number of pupils	3	7	9	5	10	6	3

- (a) How many pupils borrowed at least 3 books?
 (b) What was the total number of books borrowed by the pupils of Primary 5A?

Ans: (a) _____ [2]

(b) _____ [2]

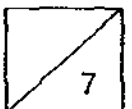

Do not write
in this column

- 12 The following tank has a square base of side 40 cm. It is filled with water to a height of 8 cm. If 32 litres more of water is needed to fill the tank completely, what is the height of the tank?

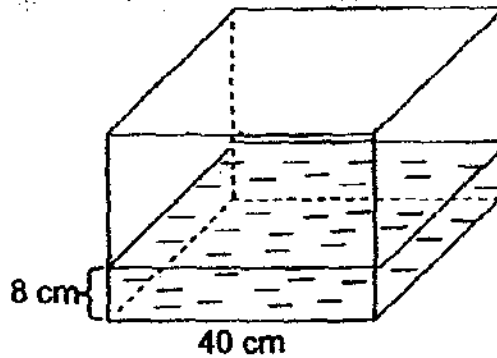

Ans: _____ [4]

- 13 Figures A and B are each made up of 3 identical rectangles. Both figures have the same area of 384 cm^2 each. What is the perimeter of Figure B?



Figure A

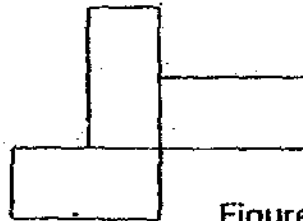
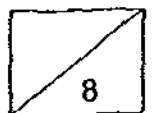
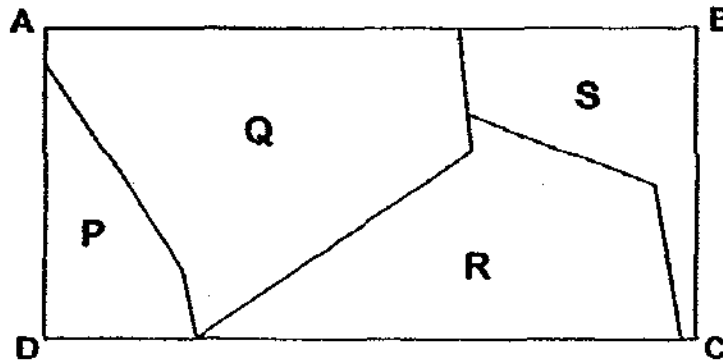

Figure B

Ans: _____ [4]



- 14 The following figure shows a rectangle ABCD which is divided into four parts P, Q, R, S. The ratio of Area P to Area Q is 1 : 3 and the ratio of Area Q to Area R is 4 : 3. The ratio of Area R to Area S is 2 : 1. If the area of S is 126 cm^2 , what is the area of Rectangle ABCD?



Ans: _____ [4]



Do not write in
this column

- 15 30% of the buffaloes in a herd were males. When 60 more female buffaloes joined the herd, the percentage of male buffaloes in the herd dropped to 20%. How many male buffaloes were there in the herd?

Ans: _____ [4]

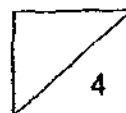

- 16 The following shaded figure is made up of a square and 2 triangles.
Find the total area of the shaded figure.

Do not write
this column

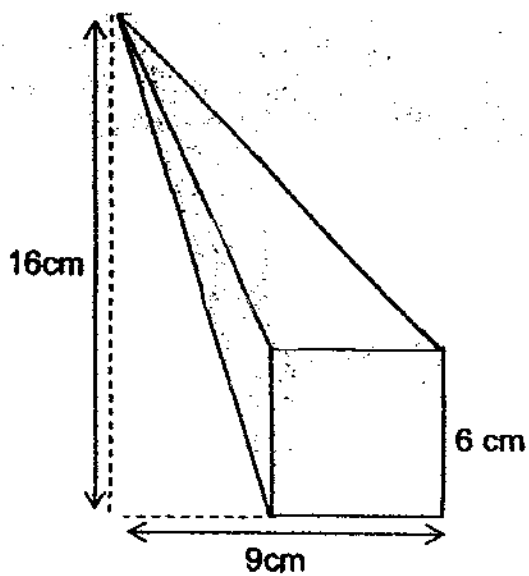

Ans: _____ [5]

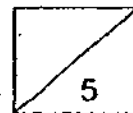

- 17 A total of 350 children joined Camp A and Camp B. Camp A was for girls while Camp B was for boys. There were $\frac{2}{5}$ as many girls as boys. After the first day, more children joined both camps. For every 2 additional girls who joined Camp A, 1 additional boy joined Camp B. Given that there was an equal number of boys and girls after the first day, how many additional boys joined Camp B?

Do not write in this column.

Ans: _____ [5]

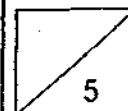

- 18 Zara had 70 more dresses than skirts. She sold $\frac{3}{4}$ of the dresses and $\frac{3}{5}$ of the skirts. She sold 126 more dresses than skirts. What fraction of the remaining clothes that Zara had were skirts?

Do not write
this column

Ans: _____ [5]

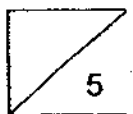

End of Paper
— Please check your work thoroughly —

ANSWER SHEET

EXAM PAPER 2009

**SCHOOL : SCGS PRIMARY
SUBJECT : PRIMARY 5 MATHEMATICS**

TERM : SA2

Q1	Q2	Q3	Q4	Q5	Q6	Q7	Q8	Q9	Q10	Q11	Q12	Q13	Q14	Q15
3	4	4	2	4	1	3	4	2	4	3	3	2	3	2

- 16)\$80000 17)1800 18)8 : 2 : 1 19)0.01 20)\$35
 21)6.96 22)6 23)9cm 24)19 more cubes
 25)5/6 26)49 27)58° 28)37.5% 29)\$2800 30)80cm

Paper 2

1)Chicken---3800g-356g=3435g Total mass---3800g+3435g =7235g =7.235kg	2)1 week---\$1.80 ÷ 3=\$0.60 20 week---\$0.60x20=\$12
3)1/5 of number---76 ÷ 2=38 Number---38x5=190 7/10 of number---7/10x190=133	4)6 sets of teacups +9 sets of cutlery ---\$184x3=\$552
5)2u→3+15=18 1u→18 ÷ 2=9 Box→9x4=36 pieces of candies.	6)15% discount→15/100x1750/1 =\$262.50 Discounted price→\$1750-\$262.50 =\$148.50 7% GST→7/100x1487.50 =\$104.125 ≈\$104
7)∠a→(180° -32°) ÷ 2=74° ∠y→74° -60° =14°	8)girls 3u x 2=6u boys 2u x 2=4u 6u→18 1u→18 ÷ 6=3 Boys (stop)→3x(9-4)=3x5=15 boys

<p>9) 7 children</p>	<p>10) Total $\rightarrow 15 \times 4 = 60$? soldiers $\rightarrow 60 \div 4 = 15$ 1 side $\rightarrow 15 + 1 = 16$ soldiers</p>
<p>11) a) pupils $\rightarrow 5 + 10 + 6 + 3 = 24$ b) 128 books</p>	<p>12) Base area $\rightarrow 40 \text{cm} \times 40 \text{cm} = 1600 \text{cm}^2$ $32 \text{L} = 3200 \text{ml} = 32000 \text{cm}^3$ Height of water $\rightarrow 32000 \text{cm}^3 \div 1600 \text{cm}^2 = 20 \text{cm}$ Height of tank $\rightarrow 20 \text{cm} + 8 \text{cm} = 28 \text{cm}$</p>
<p>13) Area of 1 rectangle $\rightarrow 384 \text{cm}^2 \div 3 = 128 \text{cm}^2$ 3 breadth $\rightarrow 24 \text{cm}$ 1 breadth $\rightarrow 24 \text{cm} \div 3 = 8 \text{cm}$ 1 length $\rightarrow 8 \text{cm} \times 2 = 16 \text{cm}$ 6 breadth $\rightarrow 6 \times 8 = 48 \text{cm}$ 4 length $\rightarrow 16 \text{cm} \times 4 = 64 \text{cm}$ Perimeter $\rightarrow 48 \text{cm} + 64 \text{cm} = 112 \text{cm}$</p>	<p>14) Area of R $\rightarrow 126 \text{cm}^2 \times 2 = 252 \text{cm}^2$ $3R \rightarrow 252 \text{cm}^2$ $1R \rightarrow 84 \text{cm}^2$ Area of Q $\rightarrow 84 \text{cm}^2 \times 4 = 336 \text{cm}^2$ Area of P $\rightarrow 336 \text{cm}^2 \div 3 = 112 \text{cm}^2$ Area of  $\rightarrow 252 \text{cm}^2 + 336 \text{cm}^2 + 112 \text{cm}^2 + 126 \text{cm}^2 = 826 \text{cm}^2$</p>
<p>15) 36 male buffaloes</p>	<p>16) Area of C $\rightarrow 6 \text{cm} \times 6 \text{cm} = 36 \text{cm}^2$ Area of A $\rightarrow \frac{1}{2} \times B \times H = \frac{1}{2} \times 6 \times 10 = 30 \text{cm}^2$ Area of rectangle $\rightarrow 16 \text{cm} \times 9 \text{cm} = 144 \text{cm}^2$ Area of D $\rightarrow \frac{1}{2} \times B \times H = \frac{1}{2} \times 9 \times 10 = 45 \text{cm}^2$ Area of E $\rightarrow \frac{1}{2} \times B \times H = \frac{1}{2} \times 3 \times 16 = 24 \text{cm}^2$ Area of figure $\rightarrow 144 \text{cm}^2 - 45 \text{cm}^2 - 24 \text{cm}^2 = 75 \text{cm}^2$</p>
<p>17) 150 additional boys</p>	<p>18) 7/12</p>