

SINGAPORE CHINESE GIRLS' SCHOOL
SECOND SEMESTRAL ASSESSMENT 2009
PRIMARY 3
MATHEMATICS

Name : _____ ()

Date _____

Class : Primary 3 SY / G / SE / P

Duration : 1 h 45 mins

Parent's Signature : _____

Marks :

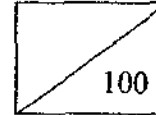

Section A (40 marks)

Questions 1 – 20 carry 2 marks each. For each question, 4 options are given. One of these is the correct answer. Make your choice (1, 2, 3 or 4). Shade the correct oval in the Optical Answer Sheet (OAS).

1. $5193 = 5000 + \underline{\hspace{2cm}} + 3$

~~(1)~~ 9

~~(2)~~ 90

~~(3)~~ 190

~~(4)~~ 193

2. What is the sum of 3 thousands, 4 tens and 1 one?

~~(1)~~ 3014

~~(2)~~ 3041

~~(3)~~ 3104

~~(4)~~ 3401

3. $378 \div 7 = \underline{\hspace{2cm}}$

~~(1)~~ 7

~~(2)~~ 54

~~(3)~~ 70

~~(4)~~ 577

4. How much more water must be added to Container A below so that it contains 450 ml?

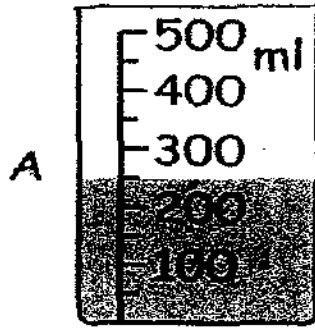

- (1) 150 ml (2) 200 ml
 (3) 250 ml (4) 650 ml

5. I started doing my homework at 10.15 am as shown below. I completed my homework at 12.05pm. How long did I take to do my homework?



- (1) 1 h 10 min (2) 1 h 50 min
 (3) 2 h 10 min (4) 2 h 50 min

6. The picture below is made up of rectangles, triangles and ovals. How many pairs of parallel lines are there in the picture below?

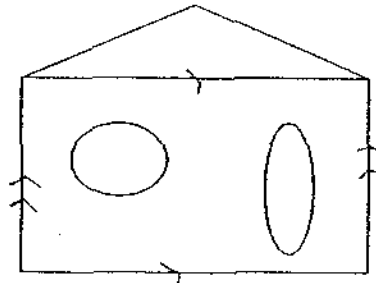

- (1) 1 (2) 2
 (3) 3 (4) 4

7. Which figure below has the largest perimeter?

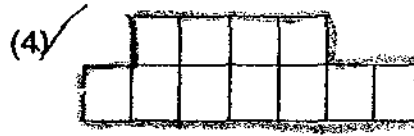
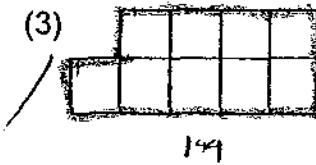
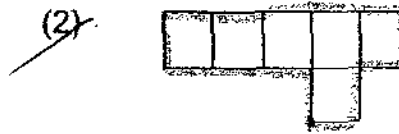
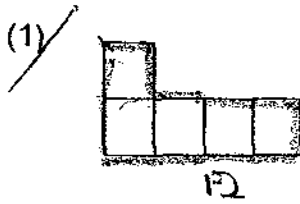

8. $350 \div 5 = 100 - \square$. What is the number in the box?

(1) 30

(2) 70

(3) 300

(4) 700

9. Patrick had 96 stickers. He packed them into bags of 7 stickers each. How many stickers were left over?

(1) 1

(2) 2

(3) 3

(4) 5

10. James has 45 stamps. He has 3 times as many stamps as Ben. How many stamps does Ben have?

(1) 15

(2) 42

(3) 48

(4) 135

11. Batteries are sold in packs of 4 at \$1.50 each pack. What is the cost of 16 batteries?

~~(1)~~ \$2.50

~~(2)~~ \$5.50

~~(3)~~ \$6.00

~~(4)~~ \$24.00

12. A glass was completely filled with water. Mary spilled half of the water and found that there was 125 ml left. What was the capacity of the glass?

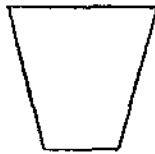

~~(1)~~ 100 ml

~~(2)~~ 110 ml

~~(3)~~ 250 ml

~~(4)~~ 340 ml

13. Which fraction is the smallest?

~~(1)~~ $\frac{1}{5}$

~~(2)~~ $\frac{5}{6}$

~~(3)~~ $\frac{3}{4}$

~~(4)~~ $\frac{1}{2}$

14. The breadth of a rectangle is 7 cm. Its length is twice the breadth. Find its area.

~~(1)~~ 14 cm²

~~(2)~~ 27 cm²

~~(3)~~ 89 cm²

~~(4)~~ 98 cm²

15. Fred had \$64. He wanted to buy 9 files but he needed \$17 more than what he had to buy them. How much did 1 file cost?

(1) ✓ \$7

(2) ✓ \$9

(3) ✓ \$20

(4) ✓ \$63

16. Bala ate $\frac{3}{8}$ of a pie. Chin Han ate $\frac{1}{4}$ of the same pie.

How much more pie did Bala eat than Chin Han?

(1) ✓ $\frac{1}{8}$

(2) ✓ $\frac{1}{4}$

(3) ✓ $\frac{1}{2}$

(4) ✓ $\frac{5}{8}$

17. Look at the figures below. Two sticks are planted into the ground. Stick X is 15 cm longer than Stick Y. Stick Y is 1 m long. What is the length of the shaded part of Stick X?

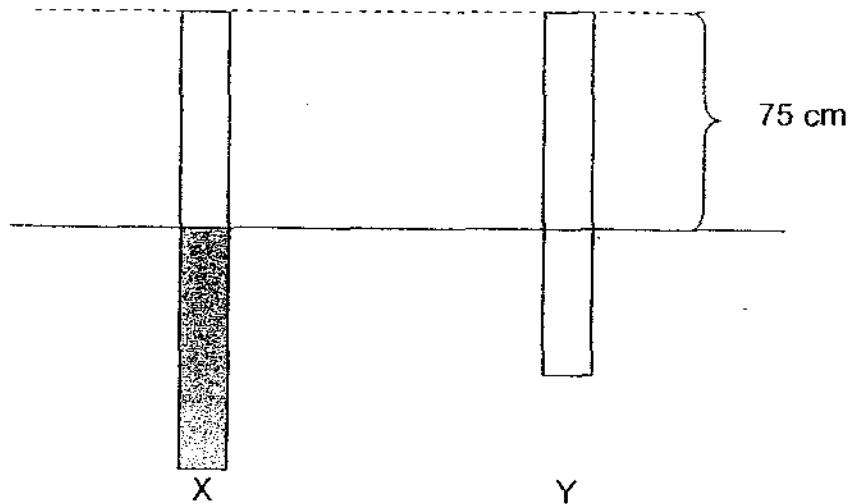

(1) ✓ 25 cm

(2) ✓ 40 cm

(3) ✓ 75 cm

(4) ✓ 115 cm

18. What is the mass of one black ball?

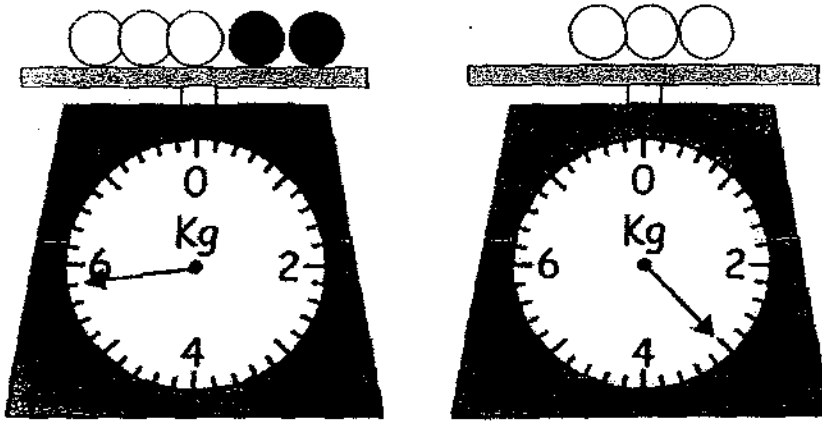

- (1) 1400 g (2) 2800 g
(3) 3000 g (4) 5800 g

19. Garbage bins are put at an equal distance along a walking path. The distance between the 1st and the 2nd bin is 50 m. How far apart is the 1st to the 7th bin?

- (1) 300 m (2) 350 m
(3) 3000 m (4) 3500 m

20. The figure below is not drawn to scale. The perimeter of the figure below is 40 cm. What is the length of AB?

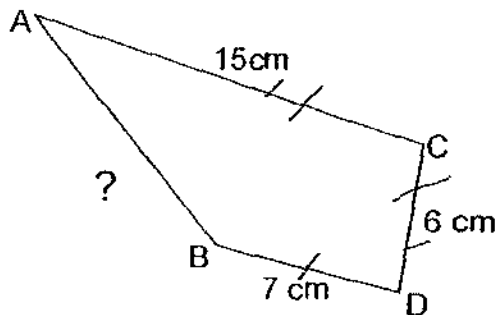

- (1) 12 cm (2) 13 cm
(3) 28 cm (4) 68 cm

SINGAPORE CHINESE GIRLS' SCHOOL
SECOND SEMESTRAL ASSESSMENT 2009
PRIMARY 3
MATHEMATICS

Name : _____ ()

Date : _____

Class : Primary 3 SY+G (G) / SETP

Duration : 1 h 45 mins

Parent's Signature : _____

Section B (40 marks)

Questions 21 – 40 carry 2 marks each. Write your answers in the blanks provided. All working must be shown clearly.

21. What is the value of the digit 8 in 5802?

Ans : _____

22. 3 h 25 min + 1 h 43 min = _____ h _____ min

Ans : _____ h _____ min

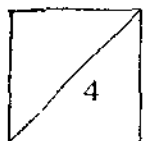

23. Jerry had 2 m of string. He used 92 cm to tie a parcel. How much string had he left?

Ans: _____ cm

24. The graph below shows the favourite fruits of a class of pupils.

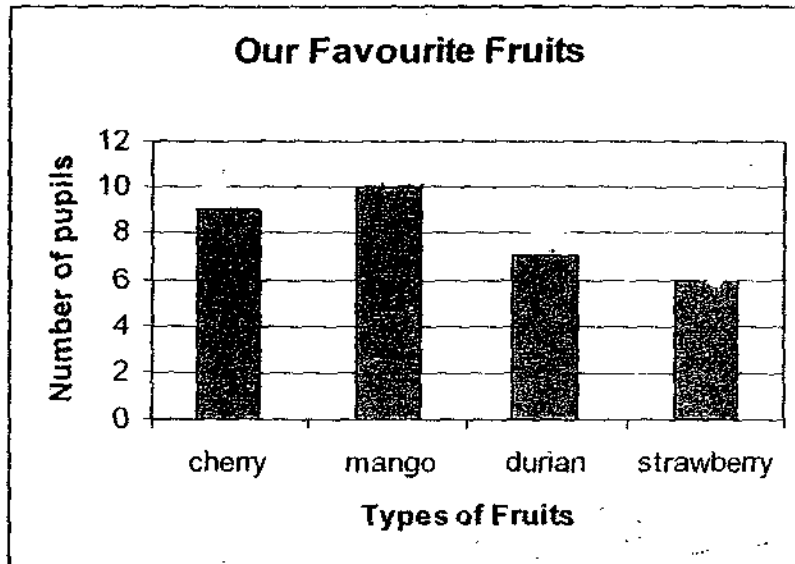

How many pupils are there in the class?

Ans: _____

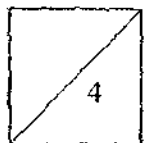

25. $\frac{1}{2} + \frac{3}{8} = \boxed{}$. What is the missing fraction in the box?

Ans : _____

26. Express $\frac{6}{9}$ as a fraction in its simplest form.

Ans : _____

27. How many angles in the figure below are more than 90 degrees?

a right angle.

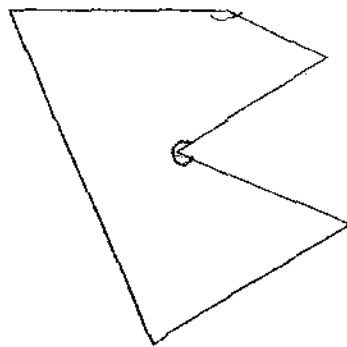

Ans : _____

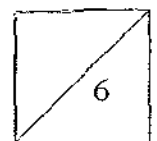

28. What is the number in the blank below?

100. 200. 250. 350. 400, 500, _____

Ans: _____

29. The cost of each kind of fruit is shown below.

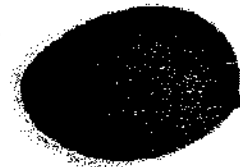

Apple	Orange	Bananas	Mango
70 cents each	\$1 each	55 cents each	\$1.10 each

Anna spent \$5.00 on 5 fruits. She bought 3 mangoes, 1 apple and _____. Which other fruit did she buy?

Ans: _____

30. A bag with 9 books weighed 2 kg 300 g. The mass of a book was 150 g. What was the mass of the bag?

Ans: _____ g



31. Flight SQ22 took off from Singapore for Hong Kong at the time shown below.

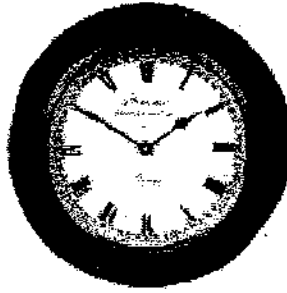

The flight took 3h 20 minutes. At what time did the flight land in Hong Kong?

Ans : _____ pm

32. The graph below shows the amount of money Danny spent on the following items during his holiday.

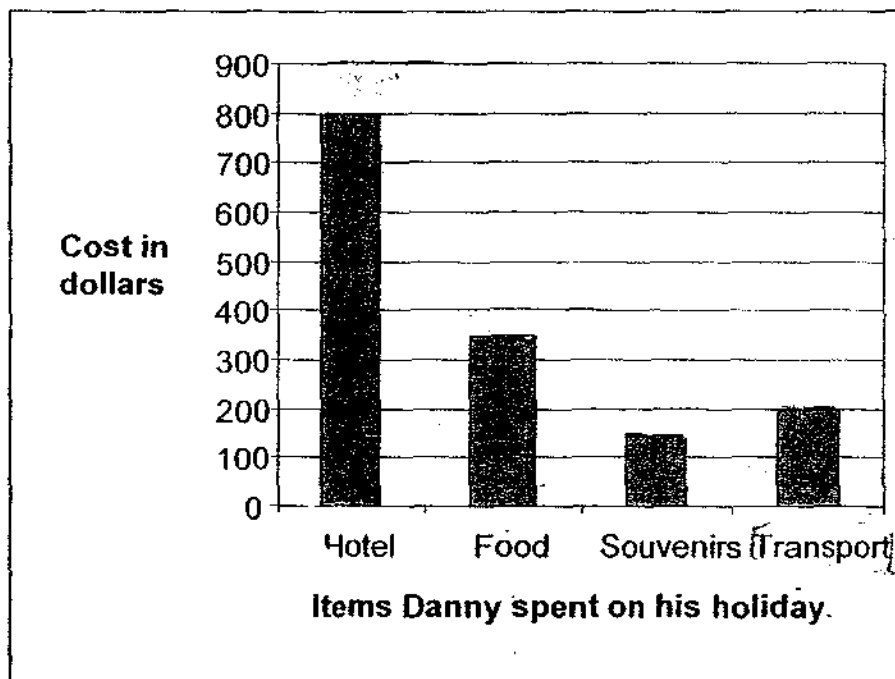

Danny spent _____ times as much on hotel charges as on transport.

Ans : _____

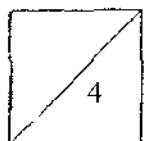

33. Andy bought a pizza. He gave $\frac{3}{10}$ of it to his brother and $\frac{1}{10}$ of it to his sister. What fraction of the pizza had he left?
(Express your answer in its simplest form).

Ans : _____

34. The fraction strip below shows $\frac{9}{10}$ of it shaded.

Before

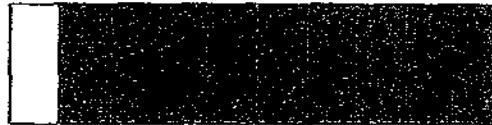

Some parts of the fraction strip above were erased and only $\frac{2}{5}$ was left shaded as shown below.

After



How many parts were erased?

Ans: _____

35. Find the difference in area between the rectangle and the square below.

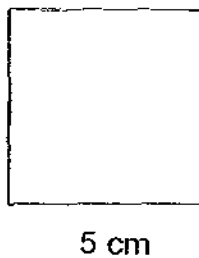
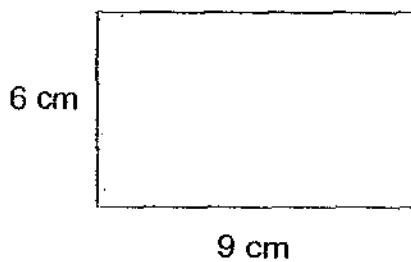

Ans: _____ cm²



36. Christine and Lai Peng had the same number of sweets. How many sweets must Christine give to Lai Peng so that Lai Peng would have 20 more sweets than Christine?

Ans: _____

37. The prices of milk powder are shown below.

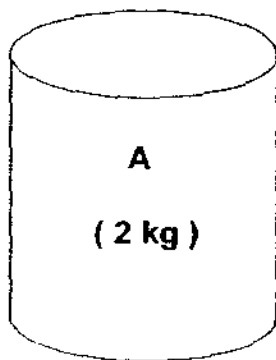

\$23.50

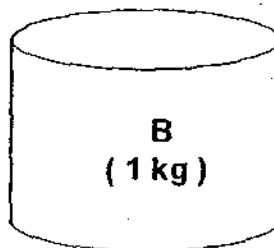

\$13.00

Jane wants to spend the least amount of money to buy 5 kg of milk powder for her childcare centre. How many of each tin should she buy?

Ans: _____

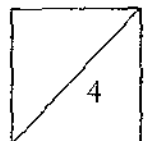

38. Ten pails were needed to fill up a fish tank. The tank had a capacity of 8 litres. Three pails were spilled. How much water was spilled?

Ans: _____ l _____ ml

39. When Muthu was sick, his doctor told him to take his pills every 8 hours, 3 times a day. He took his last pills at 11 pm. At what time did he start taking his pills?

Ans: _____ am

40. Look at the picture below. It is made up of squares.

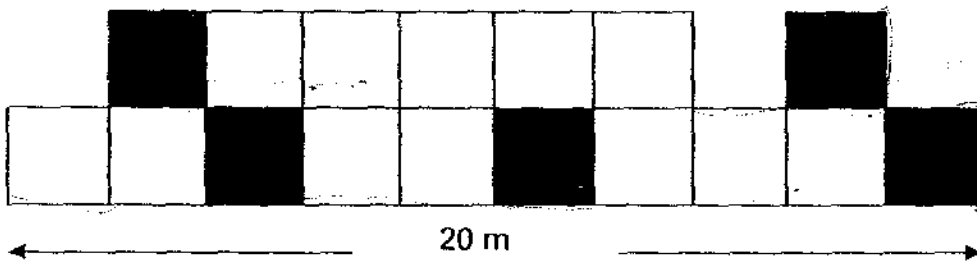

Find the total area of the shaded squares.

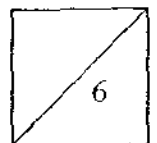

Ans: _____

Section C (20 marks)

Questions 41 – 45 carry 4 marks each. All working must be clearly shown.

41. Mike had 300 stickers. He gave half of them to his brother and lost 80 in a game. How many stickers had he left?

Ans: _____

42. Mary bought 4 files. She paid the cashier \$15 and received \$3 as change. How much did 1 file cost?

Ans: _____

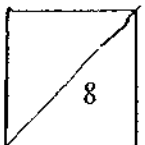

43. There were 3 parcels, A, B and C. Parcel A is 3 kg. Parcel A is twice as heavy as Parcel C. Parcel B is 500 g heavier than Parcel A. Find the total mass of the 3 parcels.

Ans: _____

44. David had 5 m of raffia. He used 3m 20 cm to tie a parcel and cut the remainder into 9 pieces. How long was each piece?

Ans: _____

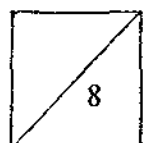

45. Alex and Mary had \$180. After Alex gave \$30 to Mary, he had 3 times as much money as Mary. How much money did Alex have at first?

Ans: _____

END OF PAPER
CHECK YOUR WORK

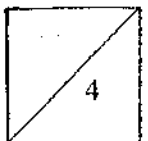

EXAM PAPER 2009**SCHOOL : SCGS PRIMARY**
SUBJECT : PRIMARY 3 MATHEMATICS**TERM : SA2**

Q1	Q2	Q3	Q4	Q5	Q6	Q7	Q8	Q9	Q10	Q11	Q12	Q13	Q14	Q15	Q16	Q17
3	2	2	2	2	2	4	1	4	1	3	3	1	4	2	1	2

Q18	Q19	Q20
1	1	1

- 21)800 22)5h 8min 23)108cm 24)32 25)7/8 26)2/3
- 27)2 28)550 29)Orange 30)950g 31)5.10pm 32)4
- 33)3/5 34)5 35)29cm² 36)10 37)2 tins of A and 1 tin of B
- 38)2L 400ml 39)7.00am 40)20m²
- 41)Half--- $300 \div 2 = 150$
Leaf--- $150 - 80 = 70$ stickers
- 42)4u → $\$15 - \$3 = \$12.00$
1u → $\$12 \div 4 = \3.00
- 43)8kg
- 44)20cm
- 45) $30 \times 4 = 120$
4u → $180 - 120 = \$60$
1u → $\$60 \div 4 = \15
Alex- $(30 \times 4) + (15 \times 3) = 120 = \165