



RED SWASTIKA SCHOOL

RED SWASTIKA SCHOOL

2009 END-OF-YEAR EXAMINATION

MATHEMATICS

Name : _____ ()

Class : Primary 4 / _____

Date : 27 October 2009

BOOKLET A

20 Questions

40 Marks

Duration of Paper : 1 hour 45 minutes

Note:

1. Do not open this Booklet until you are told to do so.
2. Questions 1 - 20 are to be done on the OAS provided.
3. Read carefully the instructions given at the beginning of each part of the Booklet.
4. Do not waste time. If a question is difficult for you, go on to the next one.
5. Check your answers thoroughly and make sure you attempt every question.

Questions 1 to 20 carry 2 marks each. For each question, four options are given. One of them is the correct answer. Make your choice (1, 2, 3 or 4). Shade the correct oval (1, 2, 3 or 4) on the Optical Answer Sheet.

(40 marks)

1 50 thousands, 3 tens is the same as _____

- (1) 503
- (2) 5 030
- (3) 50 003
- (4) 50 030

2 Which of the following numbers when rounded off to the nearest ten becomes 72 500?

- (1) 72 444
- (2) 72 496
- (3) 72 506
- (4) 72 554

3 How many one-fifths are there in 3 wholes?

- (1) $\frac{3}{5}$
- (2) $2\frac{4}{5}$
- (3) 5
- (4) 15

4 What fraction of the shapes in the box are  ?

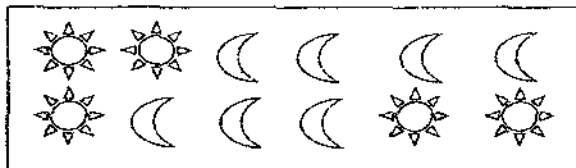

- (1) $\frac{1}{2}$
- (2) $\frac{2}{3}$
- (3) $\frac{5}{12}$
- (4) $\frac{7}{12}$

- 5 In the figure below, which angle is greater than a right angle?

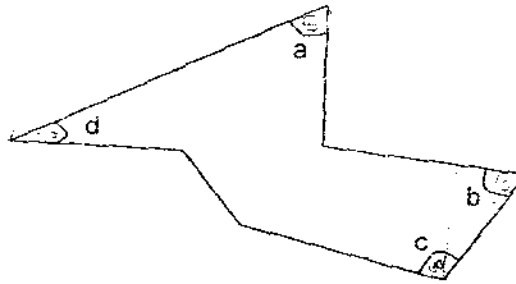

- (1) $\angle a$
(2) $\angle b$
(3) $\angle c$
(4) $\angle d$
- 6 $40.08 \times 8 =$ _____
- (1) 5.01
(2) 32.08
(3) 48.08
(4) 320.64
- 7 In which of the following numbers does the digit '5' have the smallest value?
- (1) 30 594
(2) 35 831
(3) 36 985
(4) 37 350
- 8 Study the figure below. How many line(s) of symmetry is/are there?



- (1) 1
(2) 2
(3) 3
(4) 4

- 9 Poh Han has twice as many phone cards as Jonathan. If Poh Han gives Jonathan 24 phone cards, they will each have the same number of phone cards. How many phone cards do they have altogether?

- (1) 48
- (2) 72
- (3) 96
- (4) 144

- 10 The figure below is made up of 5 triangles. What is the sum of all the angles in Triangles A, B, C, D and E?

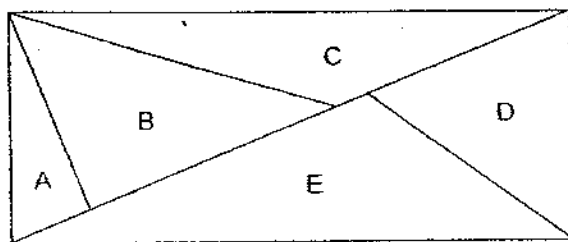

- (1) 360°
 - (2) 900°
 - (3) $1\,440^\circ$
 - (4) $1\,800^\circ$
- 11 Jeremy is standing at point A and facing West. He turns through 2 right angles in the anti-clockwise direction, followed by 135° in the clockwise direction. Which direction is he facing now?

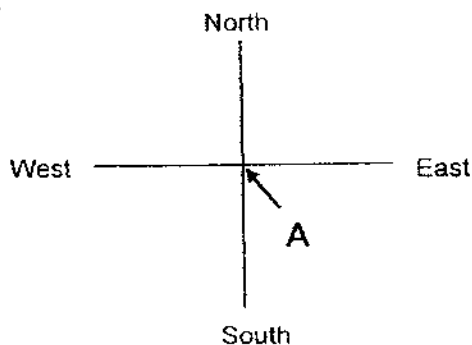

- (1) North-East
- (2) North-West
- (3) South-East
- (4) South-West

12 How many pairs of parallel lines can you see in the figure below?

- (1) 6
- (2) 5
- (3) 3
- (4) 4

13 The rectangle below is not drawn to scale. It is made up of small identical squares. The perimeter of each small square is 12 cm. What is the area of the rectangle?

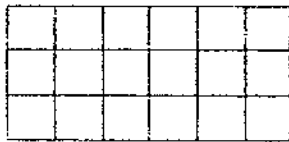

- (1) 54 cm^2
- (2) 108 cm^2
- (3) 162 cm^2
- (4) 216 cm^2

14 0.7 is made up of _____ hundredths.

- (1) 7
- (2) 70
- (3) 700
- (4) 7 000

15 $6.005 = 6 + \frac{5}{\square}$

- (1) 1
- (2) 10
- (3) 100
- (4) 1 000

- 16 Round off the value of $9\frac{4}{6}$ to 2 decimal places.
- (1) 9.04
 - (2) 9.40
 - (3) 9.60
 - (4) 9.67
- 17 Joe has six 20-cent coins and three 50-cent coins. He puts all the coins into a piggy coin box. How much does he put into the box?
- (1) \$ 0.70
 - (2) \$ 2.70
 - (3) \$ 7.00
 - (4) \$ 17.00
- 18 Patricia had 28.3 kg of mutton. She sold 11.45 kg to Mr Koh and 12.85 kg to Sammy. The remaining amount of mutton was packed equally into 5 packets. How much mutton was there in each packet?
- (1) 0.75 kg
 - (2) 0.80 kg
 - (3) 1.20 kg
 - (4) 4.00 kg
- 19 When it is 07 00 in Singapore, it is 09 00 in Australia. Mrs Kwek called her daughter who was studying in Australia at 15 30 Singapore time. What was the time in Australia when Mrs Kwek called her daughter?
- (1) 12.30 p.m.
 - (2) 3.30 p.m.
 - (3) 5.30 p.m.
 - (4) 7.30 p.m.
- 20 What is the difference between the fourth multiple of 6 and the sum of all the factors of 10?
- (1) 18
 - (2) 10
 - (3) 6
 - (4) 4

Questions 21 to 30 carry 1 mark each. Questions 31 to 40 carry 2 marks each. Show your working clearly in the space below each question and write your answers in the spaces provided. For questions which require units, give your answers in the units stated.

(30 marks)

- 21 What is 11 hundreds subtracted from the sum of 14 thousands and 13 ones?

Ans: _____

- 22 Arrange all the digits 2, 0, 6, 7 and 5 to form the largest odd number.

Ans: _____

- 23 How many pairs of perpendicular lines are there in the figure below?

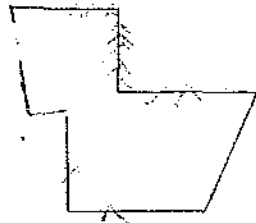

Ans: _____

- 24 A number when rounded off to one decimal place is 15.8. What could be the largest possible actual number with two decimal places?

Ans: _____

6

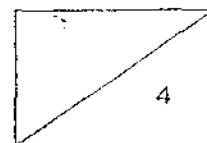

203



RED SWASTIKA SCHOOL

RED SWASTIKA SCHOOL

2009 END-OF-YEAR EXAMINATION

MATHEMATICS

Name : _____ ()

Class : Primary 4 / _____

Date : 27 October 2009

BOOKLET B

28 Questions
60 Marks

MARKS

	OBTAINED	POSSIBLE
BOOKLET A		40
BOOKLET B		60
TOTAL		100

Parent's Signature : _____

- 25 A rectangular swimming pool has a length of 17 m and a breadth of 10 m. What is the perimeter of the pool?

Ans: _____ m

The table below shows the types of CCA that Primary 4 pupils participate in. Use the information below to answer Questions 26 and 27.

	Girls	Boys	Total
Clubs	58	?	
Sports		69	104
Scouts & Brownies	45		
Total	?	126	

- 26 There are thrice as many boys participating in Sports than the Clubs. How many boys are there in the Clubs?

Ans: _____

- 27 How many girls are there altogether?

Ans: _____

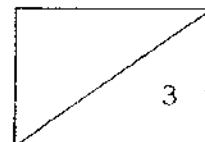

- 28 Shermaine's younger sister is 1.24 m tall. Shermaine is 0.5 m taller than her younger sister but shorter than her elder brother by 0.13 m. How tall is Shermaine's elder brother?

Ans: _____ m

- 29 The figure below is made up of a triangle and a square. What is the perimeter of the figure?

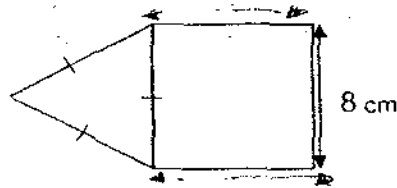

Ans: _____ cm

- 30 Uncle Tong and Aunt Mary watched a movie which ended at 22 45 on Sunday night. The movie lasted for 165 minutes. At what time did the movie begin?

Ans: _____

- 31 Fill in the blank with the correct number in the number pattern below.

78, 95, 112, _____, 146

Ans: _____

8

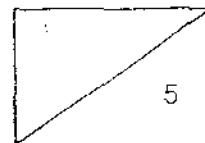

32 Write three ten thousands, seventy-two hundreds and four tens in figures.

Ans: _____

33 What is the first common multiple of 4 and 6?

Ans: _____

34 Arrange the following fractions from the smallest to the greatest.

$$\frac{2}{3}, \frac{5}{6}, \frac{1}{12}$$

Ans: _____

35 What fraction of the figure is shaded?

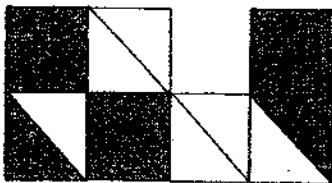

Ans: _____

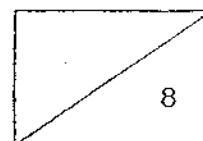

- 36 One of the lines in the figure is parallel to AD. Which line is parallel to AD?

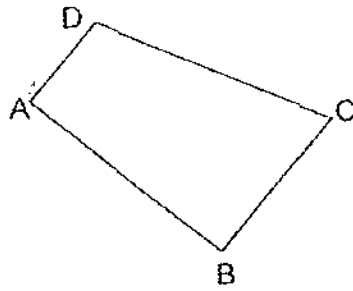

Ans: _____

- 37 Write 3 thousandths as a decimal.

Ans: _____

- 38 Write the decimal represented by A.

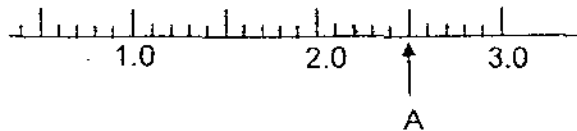

Ans: _____

- 39 $13.86 + 0.18 =$ _____

Ans: _____

- 40 The figure below shows 2 shaded squares. Shade 2 more squares to complete the figure so that the dotted line AB is a line of symmetry.

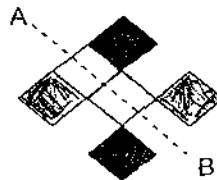

10

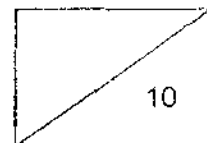

Questions 41 to 42 carry 3 marks each. Questions 43 to 48 carry 4 marks each. Show your working clearly in the space below each question and write your answers in the spaces provided.

(30 marks)

- 41 In a class, $\frac{1}{3}$ of the pupils belong to the Red House. $\frac{4}{9}$ of the pupils belong to the Yellow House. The remaining 10 pupils belong to the Blue House. How many pupils are there in the class?

_____ [3]

- 42 The figure is made up of 2 identical rectangles. The length of the rectangle is 10 cm and the breadth is 7 cm. The rectangles overlap and form a small square of area 9 cm^2 . Find the perimeter of the figure.

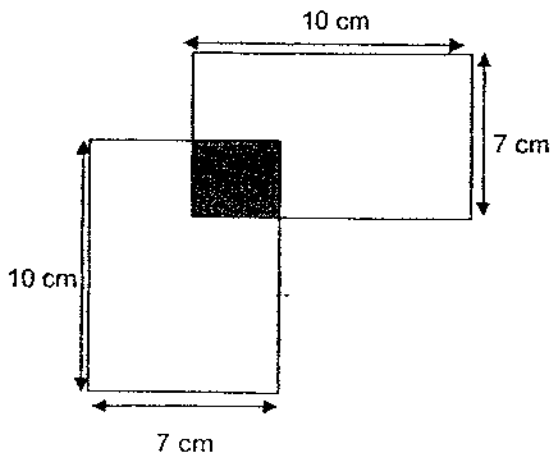

Ans: _____ [3]

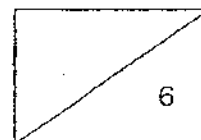

- 43 Mr Mah is thrice Tommy's age. The difference between their ages is 30. What is their total age in 5 years' time?

-
- 44 Mrs Tang walked $\frac{5}{8}$ km from her home to the supermarket. After that, she walked to the community centre which was twice the distance from her home to the supermarket. How far was the community centre from her home? (Give your answer in its simplest form.)

Ans: _____ [4]

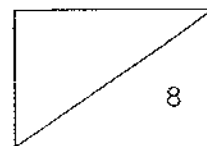

- 45 Tracy has some 50-cent and 20-cent coins. The sum of all the coins is \$7.20. If there are 30 coins altogether, how many of them are 50-cent coins?

Ans: _____ [4]

- 46 The sum of 4 numbers is 121. The first number is 9 more than the second number. The third number is 5 less than the second number. The fourth number is 3 times that of the first number. What is the first number?

Ans: _____ [4]

- 47 In a class of 40 pupils, $\frac{3}{5}$ of them are girls. $\frac{1}{2}$ of the girls and all the boys have short hair. How many pupils in the class have short hair?

Ans: _____ [4]

48. A rope has 12 knots which are spaced out equally. The distance between the first knot and sixth knot is 3.5 m. What is the distance between the third knot and the last knot?

Ans: _____ [4]

END OF PAPER

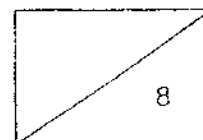

ANSWER SHEET

EXAM PAPER 2009

**SCHOOL : RED SWASTIKA PRIMARY
SUBJECT : PRIMARY 4 MATHEMATICS**

TERM : SA2

Q1	Q2	Q3	Q4	Q5	Q6	Q7	Q8	Q9	Q10	Q11	Q12	Q13	Q14	Q15	Q16	Q17
4	2	4	3	3	4	3	2	4	2	4	1	3	2	4	4	2

Q18	Q19	Q20
2	3	3

- 21)12913 22)76205 23)4 pairs 24)15.84 25)54m 26)23
27)138 28)1.87m 29)40cm 30)2000 31)129 32)37240
33)12 34)1/12, 2/3, 5/6 35)4/7 36)CB 37)0.003

- 38)2.5 39)14.04
41)45 42)56cm

- 43)2 unit \rightarrow 30
1 unit \rightarrow $30 \div 2 = 15$
Mr Mah's age \rightarrow $30 + 15 = 45$
Total age $= 15 + 5 + 45 + 5 = 70$

- 44) $1\frac{7}{8}$ km

- 45)4

- 46)6 units \rightarrow $121 - 61 = 60$
1 unit \rightarrow $60 \div 6 = 10$
 $10 + 9 + 5 = 24$
The first number is 24

40)

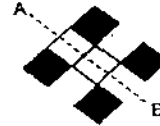

- 47)10 units \rightarrow 40
1 unit \rightarrow $40 \div 10 = 4$
No of pupils in the \rightarrow 4×7
class that have short hair $= 28$

- 48) $3.5\text{m} \div 5 = 0.7\text{m}$
 $0.7\text{m} \times 9 = 6.3\text{m}$
The distance between the third
knot to the last knot is 6.3m