



NAN HUA PRIMARY SCHOOL
SEMESTRAL ASSESSMENT 2 – 2010
PRIMARY TWO
MATHEMATICS

Time : 1 h 30 min

INSTRUCTIONS TO CANDIDATES

1. Write your name, register number and class in the blanks provided.
2. Do not turn over this page until you are told to do so.
3. Follow all instructions carefully.
4. Answer all questions.
5. Write your answers in this booklet.

Marks Obtained

Total Marks:

	/ 100
--	-------

Name : _____ ()

Class : P 2 _____

Date : 27 October 2010

Parent's Signature : _____

Date : _____

Section A (2 marks each)

Fill in each box with the correct answer.

1.

Hundreds	Tens	Ones
3	4	5

Write in words.

2. Complete the number pattern below. Write your answer in the blanks provided.

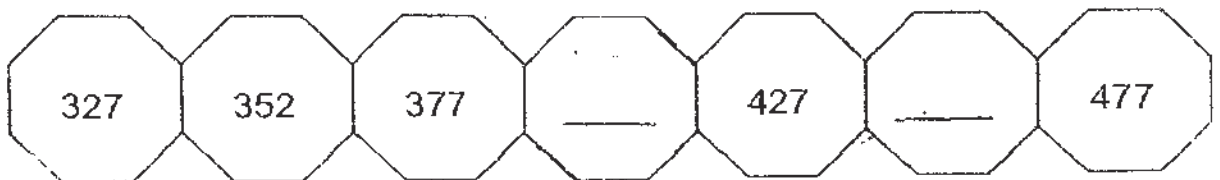

3.

719 is 30 more than

4.

— 363 = 442

5. Fill in the 2 missing numbers in the boxes.

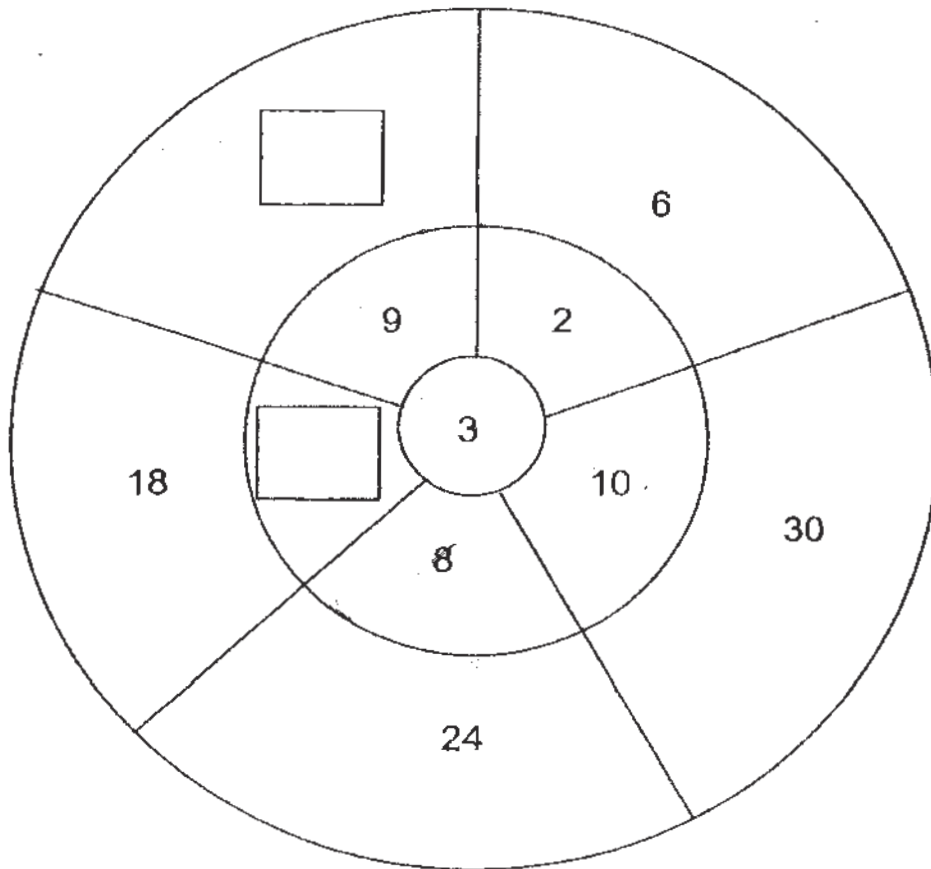

6. Write a **multiplication sentence** and a **division sentence** for the following picture.



$$\boxed{} \times \boxed{} = \boxed{}$$

$$\boxed{} \div \boxed{} = \boxed{}$$

7. Look at the following numbers.

Which **two numbers** below give a total of 1000?



The two numbers are and .

Section B (2 marks each)

Do these sums carefully.

8.

$$\begin{array}{r} 900 \\ - 99 \\ \hline \end{array}$$

9. If  stand for

18 mangoes, then  stand for mangoes.

10. Rani shared 20 slices of cakes equally with her 4 friends.
Circle the number of cakes each of them would get.

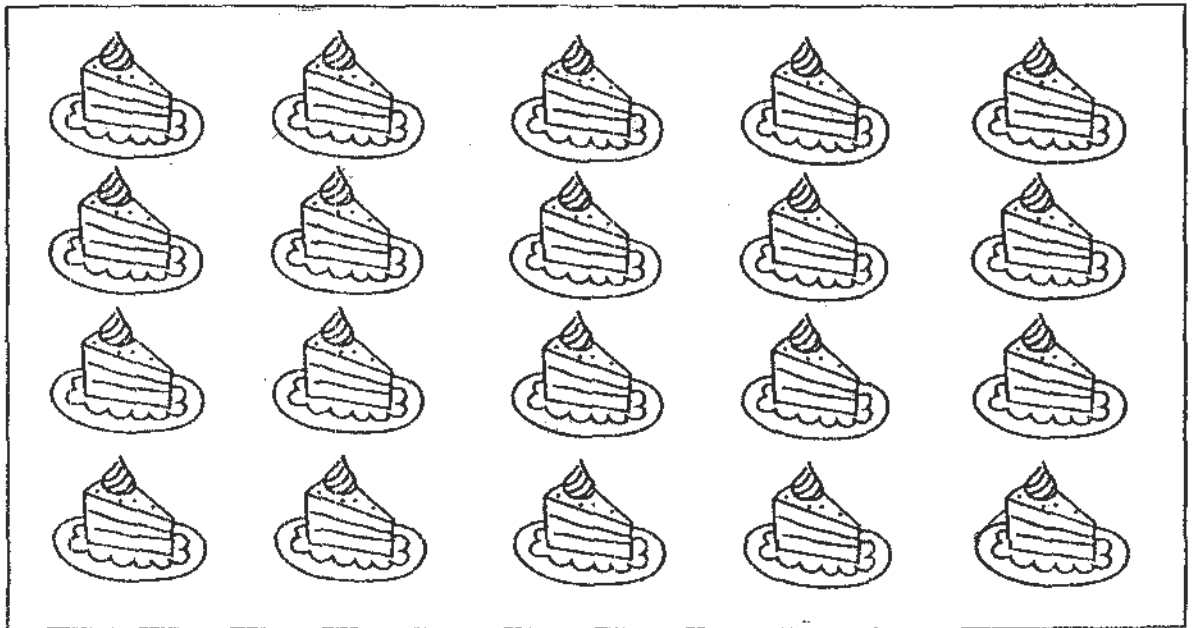

11. Mrs Tan bought 4 boxes of tarts for a party.
There were 8 tarts in each box.
How many tarts did Mrs Tan buy altogether?

Mrs Tan bought tarts.

Section C (2 marks each)

For Questions 12 to 14, study the picture below carefully and fill in the answers in the boxes provided.

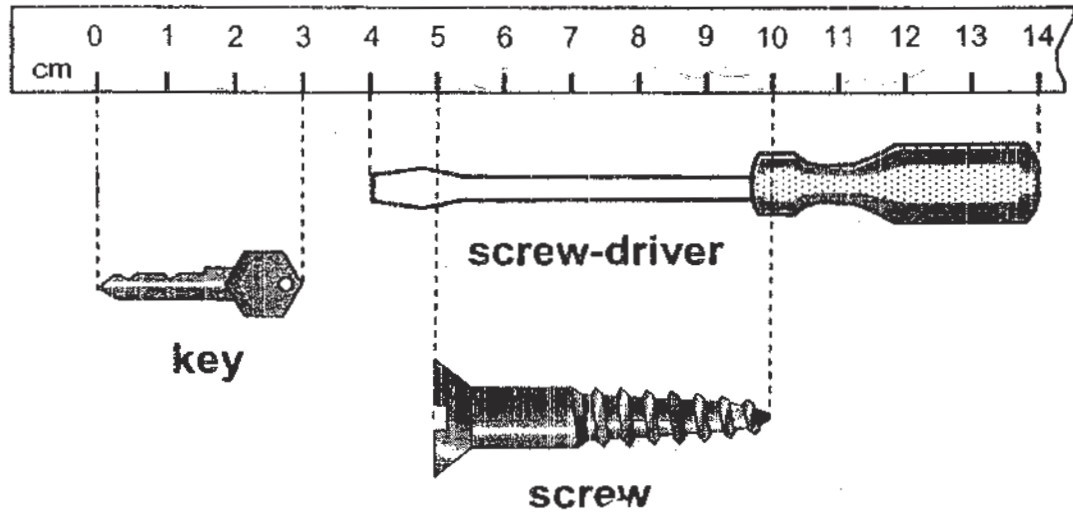

12. The screw is cm long.
13. The **total** length of the screw and the key is cm.
14. The **total** length of two screws is as long as the length of the .

Section D (2 marks each)

Do these sums carefully.

15. What fraction of the circle is shaded?

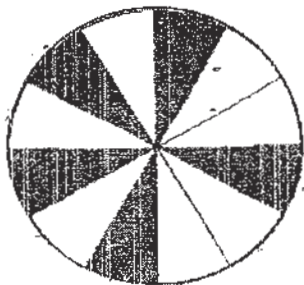

The fraction is .

16. Father bought a pizza and cut it into 4 equal slices. Peter ate 2 slices of pizza and Jane ate 1 slice of the pizza. What fraction of the pizza was left?

of the pizza was left.

17. Fill in the missing fraction in the box below.

$\frac{5}{7}$ and make 1 whole.

18. Arrange the following fractions from the greatest to the smallest.

$\frac{1}{7}$, $\frac{1}{4}$, $\frac{1}{9}$, $\frac{1}{5}$

<input type="text"/>	<input type="text"/>	<input type="text"/>	<input type="text"/>
greatest			smallest

Section E (2 marks each)

For Questions 19 to 22, fill in the answers in the boxes provided.

19. The figure below is made up of 2 shapes. Name the 2 shapes.

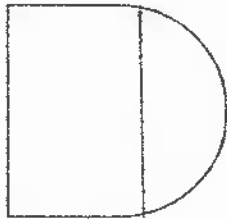

This figure is made up of a and a .

20. Look at the letters in the box below.



Which letter in the box has **both** straight line(s) and curve(s)?

Letter has **both** straight line(s) and curve(s).

21.



The object above has flat face(s).

22. Copy the given figure on the square grid provided.

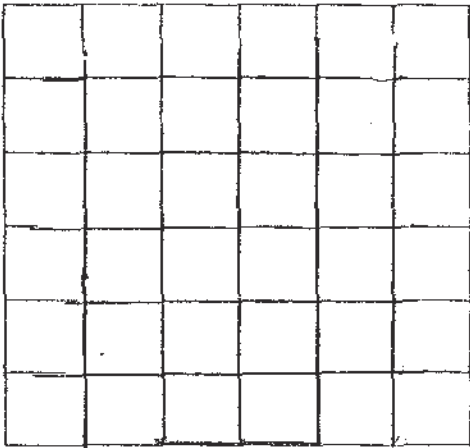
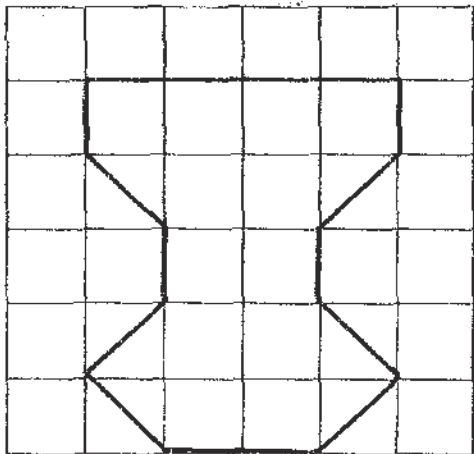

Section F (2 marks each)

For Questions 23 to 25, study the picture below carefully and fill in the answers in the boxes provided.



Container A

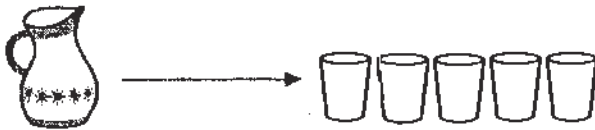

Container B



Container C

23. Container holds the **greatest** volume.

24. The three containers hold a **total** of glasses of water.

25. Container holds 6 glasses of water **fewer than** Container C.

Section G (2 marks each)

Study the picture graph carefully. Show working clearly in the space given below each question.

Write the correct answers in the boxes for Questions 26 to 28.

Number of Paper Flowers Made by the Children

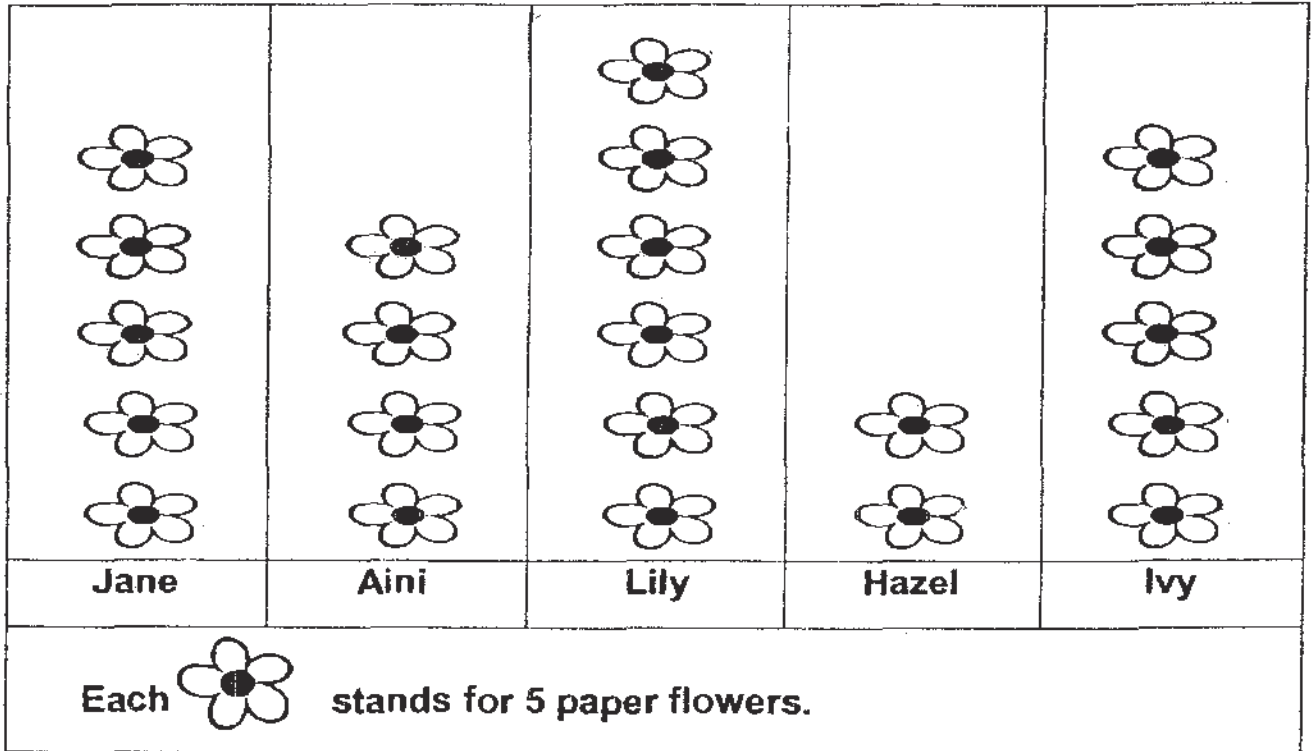

26. and made the **same number** of paper flowers.

27. Lily made paper flowers.

28. Aini wanted to make as many paper flowers as Lily.
She needed to make more paper flowers.

Study the picture graph carefully. Show your working clearly in the space given below each question.

Write the correct answers in the boxes for Questions 29 to 31.

Number of Stamps Collected by 5 Children

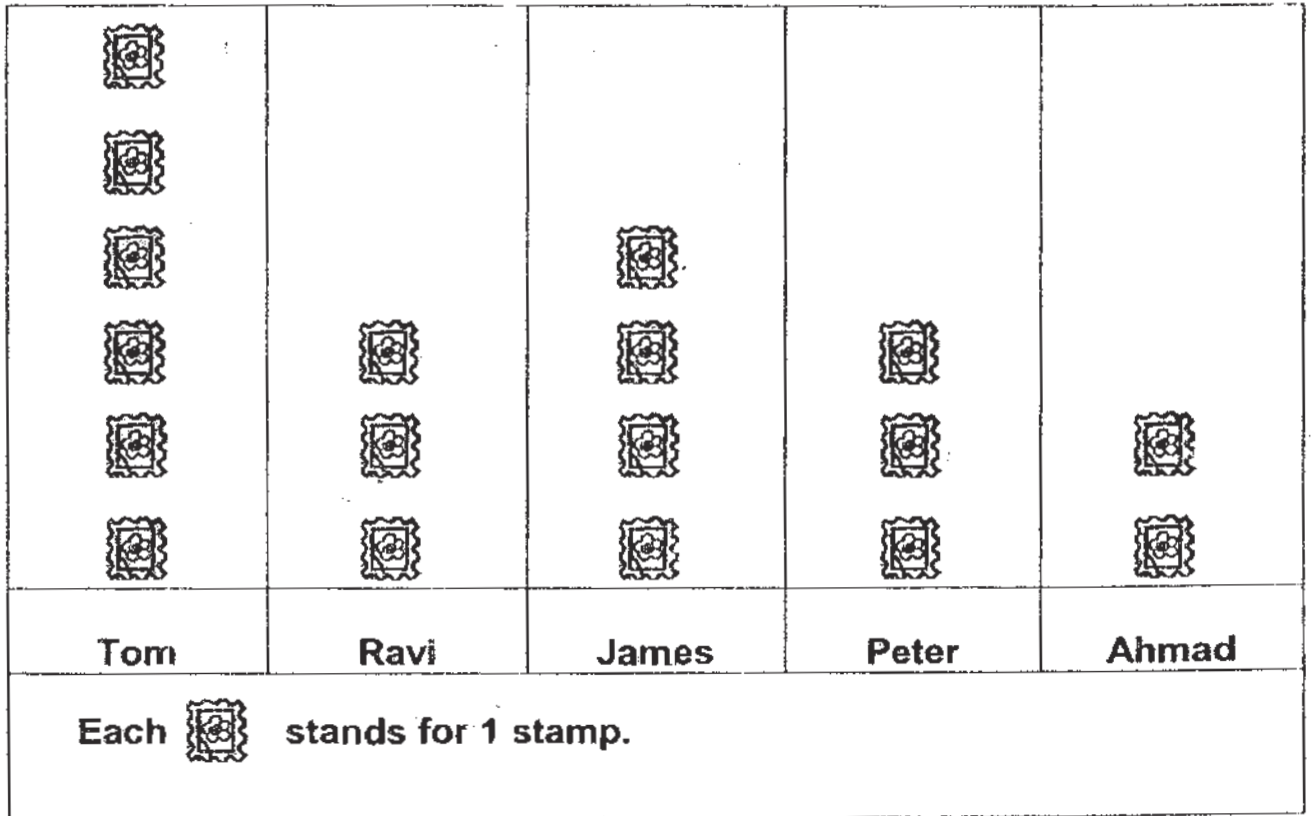

29. Tom collected stamps.

30. Ravi and James have stamps altogether.

31. has 4 more stamps than Ahmad.

Section H (2 marks each)

Look at the clocks carefully and write down the answers in the boxes provided.

32.

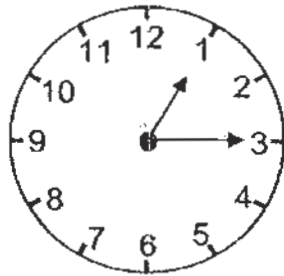

The time is p.m.

33. Draw the minute hand to show that the time is 12.50 p.m.



34. Annie leaves home at 6 o'clock in the morning and reaches the school half an hour later. How long does she take to reach the school?

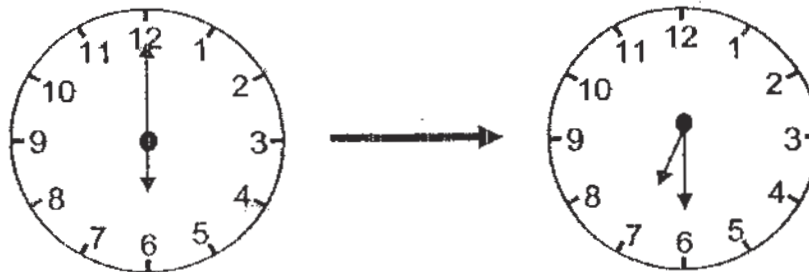

She takes minutes to reach the school.

Section I (2 marks each)

Study the picture carefully and answer Questions 35 to 37.

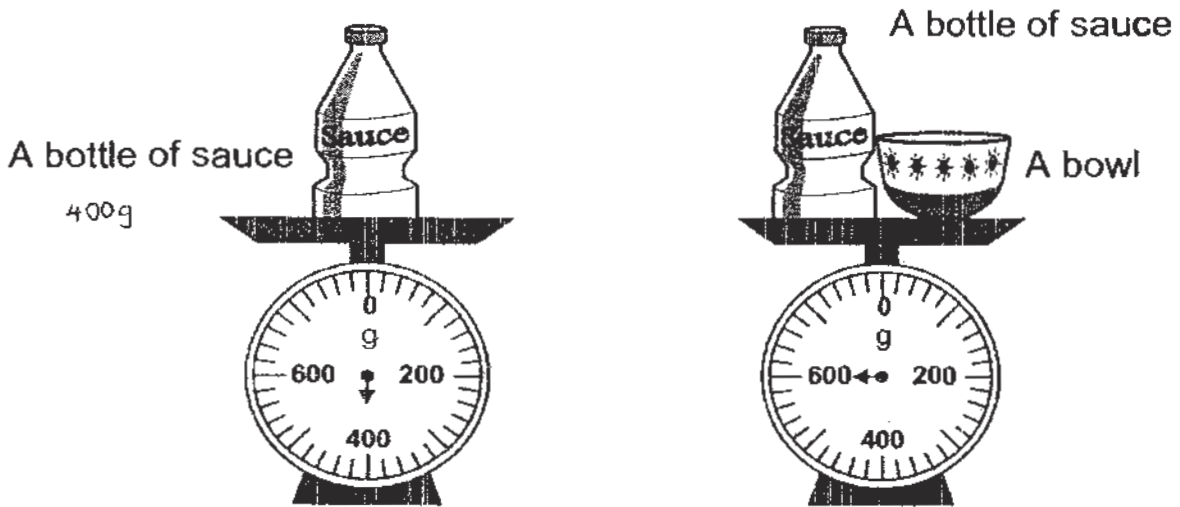

35. The mass of the bottle of sauce is g.

36. The mass of each bowl is g.

37. Using the information you have found above, how many  must be placed at position **A** so that both sides are balanced equally?

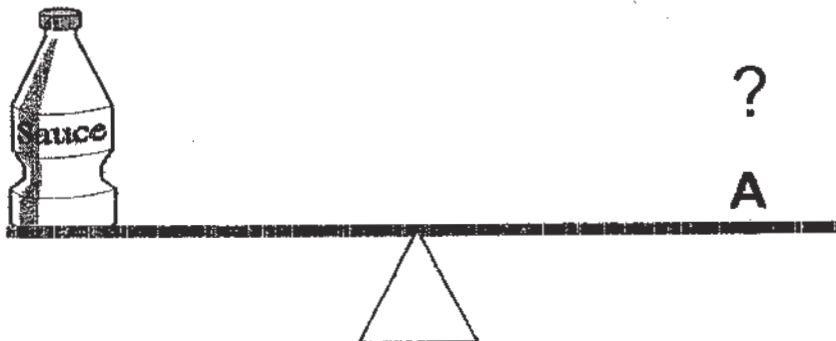

I will need 

38. Study the picture below.

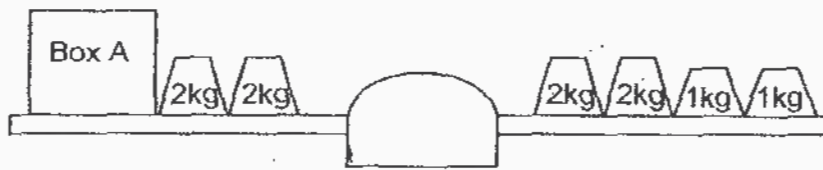

The mass of box A is kg.

Section J (2 marks each)

Study the picture given below carefully and answer Questions 39 and 40.

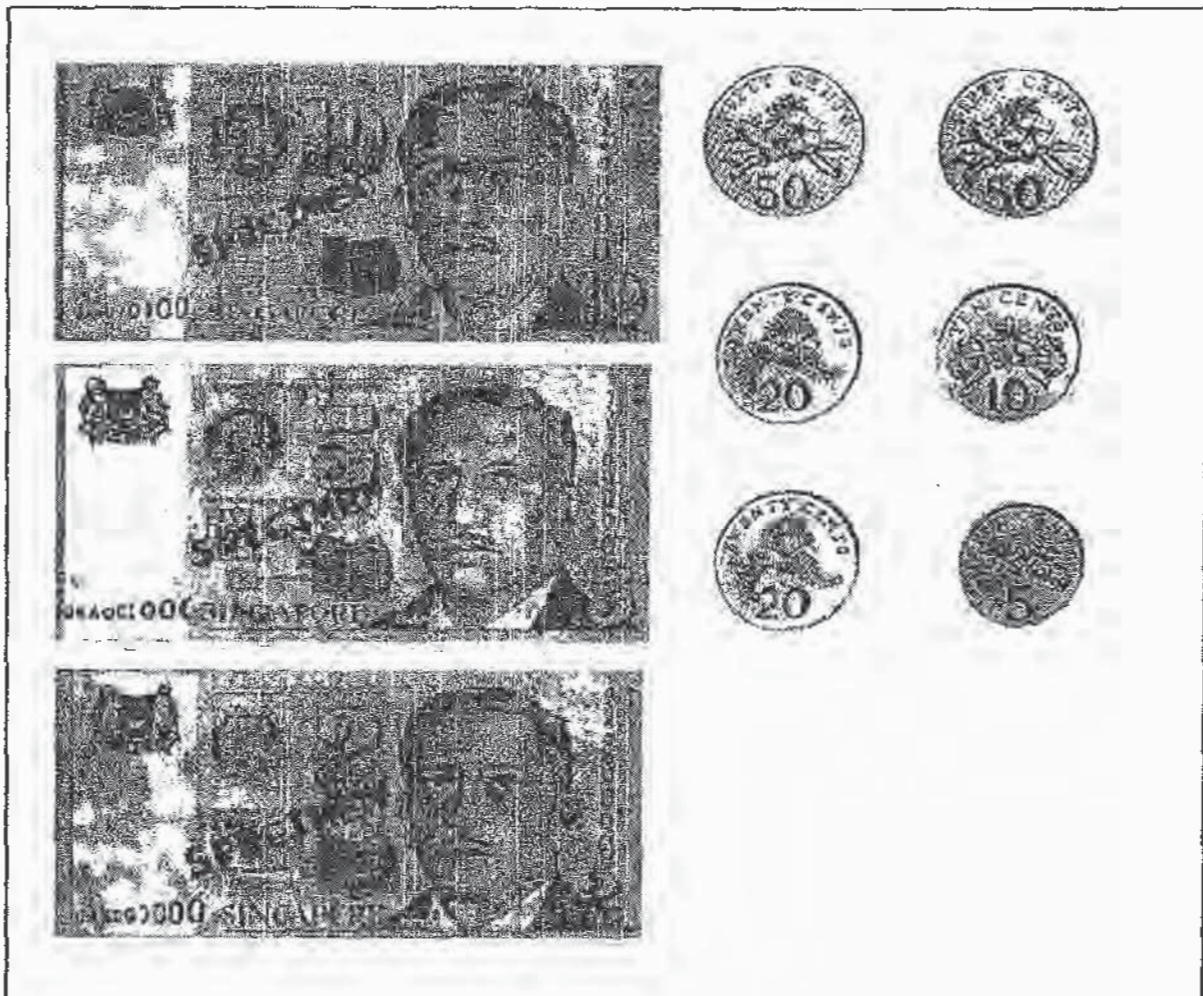

39. The total amount shown above is \$.

40. In the picture above, circle the amount that makes three dollars **and** thirty-five cents.

41. I need ten - cent coins to exchange for \$1.20.

42. Look at the pattern given in the box below. What is the **next** shape in the pattern?

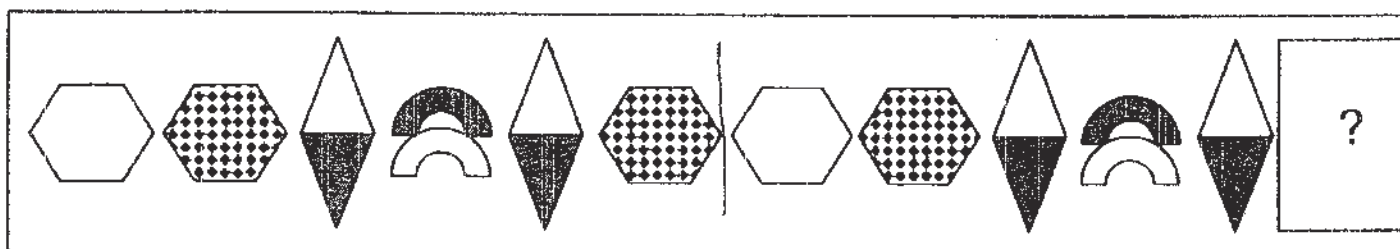

What does represent? Please circle the correct shape below.



Section K (4 marks each)

Read the story sums carefully.

Show your working and write the statements clearly.

43. Jenny has 243 stamps.
Her brother has 58 stamps more than her.
How many stamps do they have altogether?

44. Look at the picture given below.

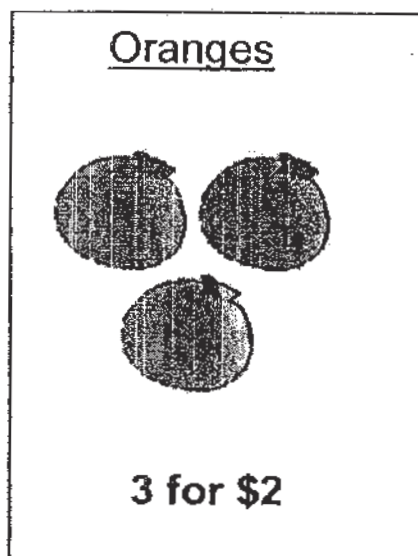
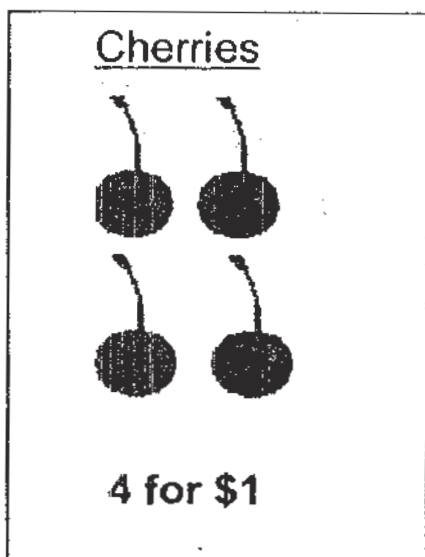

Mrs Lee bought 36 cherries and 3 oranges.
How much did she pay in all?

45. Kiki bought a handbag for \$18.

She gave the cashier a ten-dollar note **and**
two five-dollar notes.

How much change did she receive from the cashier?

46. Ravi had 48 sweets.

He shared all his sweets equally **with** his 3 brothers.

How many sweets did each boy receive?

Please check your work.

-End of Paper-

ANSWER SHEET

EXAM PAPER 2010

SCHOOL : NAN HUA PRIMARY SCHOOL
SUBJECT : PRIMARY 2 MATHEMATICS

TERM : SEMESTRAL ASSESSMENT 2

Q1) three hundred and forty-five

Q2) 402, 452 Q3) 689 Q4) 805

Q5) 27
6

Q6) $3 \times 5 = 15$
 $15 \div 3 = 5$

Q7) 363 and 637 Q8) 801 Q9) 4

Q10)

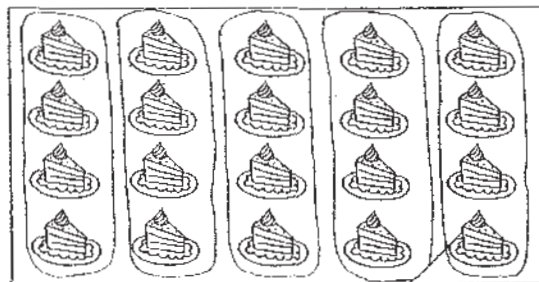

Q11) 32 Q12) 5 Q13) 8 Q14) screw-driver Q15) $5/12$ Q16) $1/4$
Q17) $2/7$ Q18) $1/4, 1/5, 1/7, 1/9$ Q19) semicircle and a rectangle
Q20) R Q21) 2

Q22)

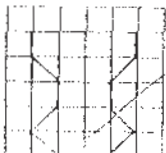

Q23)C Q24)17 Q25)A Q26)Jane and Ivy Q27)30 Q28)10
 Q29)6 Q30)7 Q31)Tom Q32)1.15pm

Q33)



Q34)30minutes Q35)400g Q36)200g Q37)2 Q38)2kg Q39)\$18.55

Q40)

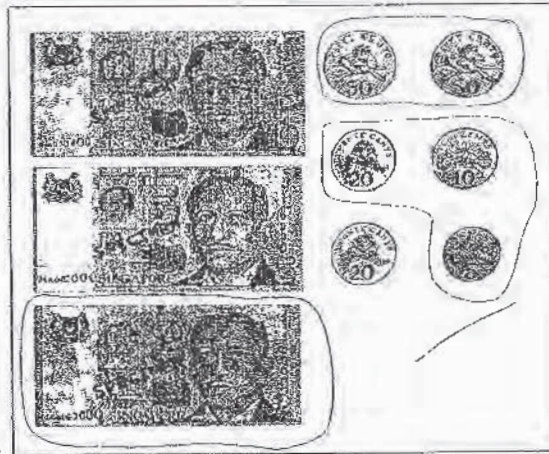

Q41)12

Q42)

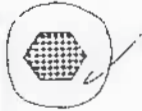

<p>Q43) $243+58=301$ $243+301=544$ They have 544 stamps altogether.</p>	<p>Q44) $36 \div 4 = 9$ $9 + 2 = 11$ She paid \$11 in all.</p>
<p>Q45) $2 \times 5 = 10$ $10 + 10 = 20$ $20 - 18 = 2$ She received \$2 from the cashier.</p>	<p>Q46) $48 \div 4 = 12$ Each boy received 12 sweets.</p>