



RED SWASTIKA SCHOOL

RED SWASTIKA SCHOOL

2010 SEMESTRAL ASSESSMENT 2

MATHEMATICS

Name : _____ ()

Class : Primary 3 / _____

Date : 26 October 2010

45 Questions

100 Marks

Duration of Paper : 1 hour 45 minutes

Note:

In this paper, you should have the following:

(a) Page 1 to Page 14

(b) Questions 1 to 45

Parent's Signature : _____

Section A : Multiple-Choice Questions

Questions 1 to 20 carry 2 marks each. For each question, four options are given. One of them is the correct answer. Make your choice (1, 2, 3 or 4). Shade the correct oval (1, 2, 3 or 4) on the Optical Answer Sheet.

(40 marks)

1 In the number 8 196, the digit 1 stands for _____.

- (1) 1
- (2) 10
- (3) 100
- (4) 1 000

2 Which of the following set of numbers is arranged from the biggest to smallest?

- (1) 9 204 , 9 024 , 9 240
- (2) 9 240 , 9 204 , 9 024
- (3) 9 024 , 9 240 , 9 204
- (4) 9 024 , 9 204 , 9 240

3 5 367 is 3 hundreds less than _____.

- (1) 5 067
- (2) 5 607
- (3) 5 667
- (4) 5 670

4 Which of the following is equivalent to 9×3 ?

- (1) 9 groups of 3
- (2) $9 \times 9 \times 9$
- (3) $27 \div 9$
- (4) 12

5 The time shown on the clock is _____.



- (1) 25 minutes to 11
- (2) 35 minutes to 10
- (3) 5 minutes past 10
- (4) 25 minutes past 10

6 Study the number pattern below.

22 , 26 , 24 , 28 , 26 , _____ , _____

What is the missing numbers?

- (1) 30, 28
- (2) 28, 24
- (3) 26, 30
- (4) 24, 26

7 A container had 4 tennis balls. There were 16 such containers. How many tennis balls were there altogether?

- (1) 64
- (2) 20
- (3) 12
- (4) 4

8 How many tens are there in 3 400?

- (1) 30
- (2) 34
- (3) 300
- (4) 340

9. A cardboard 15 m by 3 m was cut into 3 equal pieces. What was the perimeter of one of the cut pieces?

- 1 m
- 5 m
- 16 m
- 36 m

10. There were 5 630 participants in a marathon. 2 493 did not complete the marathon. Of the participants who completed the marathon, 1 465 were women. How many men completed the marathon?

- (1) 1 672
- (2) 3 137
- (3) 4 165
- (4) 9 795

11. The sum of 3 764 and 1 783 is _____ less than 7 569.

- (1) 1 981
- (2) 2 022
- (3) 3 805
- (4) 5 547

12. Babe walks 2 km to school everyday. What is the total distance she walks to school over 5 days?

- (1) 10 m
- (2) 100 m
- (3) 1 000 m
- (4) 10 000 m

13. The mass of 3 similar durians is 2 100g. What is the mass of two such durians?

- (1) 700 g
- (2) 700 kg
- (3) 1 400 kg
- (4) 1 kg 400 g

14 The length of a rope is 7 m long. It is cut into 3 pieces. The first piece is 150 cm long, the second piece is 3 m 15 cm long. What is the length of the third piece?

- (1) 2 m 35 cm
- (2) 4 m 65 cm
- (3) 11 m 65 cm
- (4) 23 m 5 cm

15 3 glasses of coke cost \$6.
How much does Janice need to pay if she buys 13 glasses of coke?

- (1) \$26
- (2) \$2
- (3) \$30
- (4) \$78

16 _____ thirds make a whole.

- (1) 1
- (2) 2
- (3) 3
- (4) 4

17 Which two fractions add up to a whole and give a difference of $\frac{1}{2}$?

- ~~(1)~~ $\frac{1}{2}$ and 1
- ~~(2)~~ $\frac{1}{6}$ and $\frac{4}{6}$
- ~~(3)~~ $\frac{1}{4}$ and $\frac{3}{4}$
- ~~(4)~~ $\frac{3}{8}$ and $\frac{7}{8}$

18 Marcus bought 3 pairs of socks at \$1.50 a pair. He gave the cashier a ten-dollar note. How much change did he receive?

- (1) \$ 4.50
- (2) \$ 5.50
- (3) \$ 8.50
- (4) \$10.00

19 Which of the following area is the largest?

- (1) 7 m x 8 m
- (2) 3 m x 12 m
- (3) 150 cm x 9 cm
- (4) 10 cm x 10 cm

20 Su has 4 two-dollar notes. She changes this amount to twenty-cent coins. How many twenty-cent coins does she get?

- (1) 20
- (2) 40
- (3) 60
- (4) 80

Section B : Short-Answer Questions

Questions 21 to 40 carry 2 marks each. Show your working clearly in the space below each question and write your answers in the spaces provided. For questions which require units, give your answers in the units stated.

(40 marks)

21 What is the sum of 3 thousands, 42 hundreds and 67 tens?

Ans: _____

22 3 h 45 min = 6 h 10 min — hr min

Ans: _____ hr _____ min

23 Arrange all the digits 3, 0, 5 and 7 to form the largest odd number.

Ans: _____

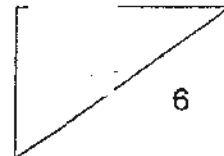

- 24 Aminah is 29 cm shorter than Jacelyn. The sum of Aminah's height and Jacelyn's height is 305 cm. What is Jacelyn's height?
(Give your answer in m and cm.)

Ans: _____ m _____ cm

- 25 A tin contained 2 l of sauce. Min poured the sauce and filled 5 similar bottles completely. Each bottle had a capacity of 110 ml. How much sauce was left in the tin?

Ans: _____ ml

- 26 The product of two numbers is 423. If one number is 3, the other number is _____

Ans: _____

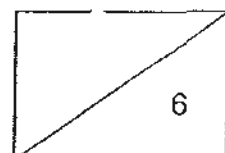

The bar graph below shows the number of tourists who visited some places in Singapore. Use it to answer Questions 27 to 30.

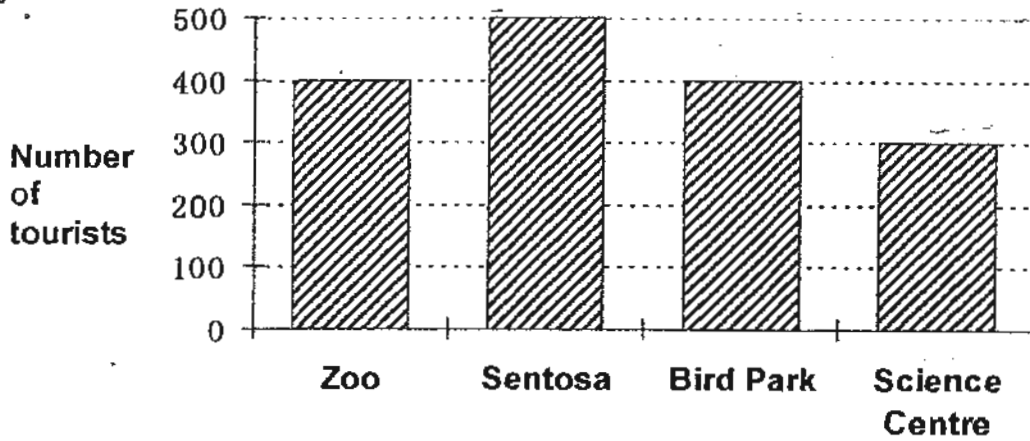

27 Which two places had the same number of visitors?

Ans: _____, _____

28 Find the total number of tourists who visited Sentosa and the Science Centre. ³⁰⁰

Ans: _____

29 How many more tourists visited Sentosa than the Bird Park?

Ans: _____

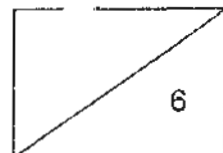

30 What was the total number of tourists who visited the four places?

Ans: _____

31 Subtract 24 tens from the product of 648 and 5.

Ans: _____

32 The remainder of 321 divided by 8 is _____.

Ans: _____

33 The product of 212 and 3 is the same as the product of 4 and _____.

Ans: _____

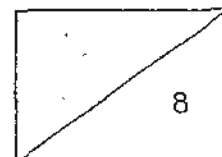

- 34 Study the figure below carefully. How many right angles are there in the figure?

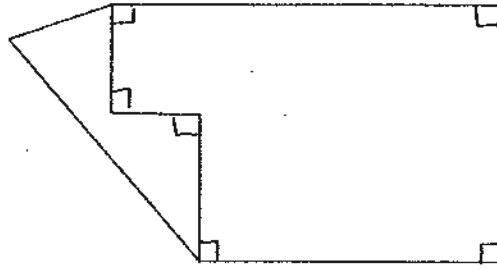

Ans: _____

- 35 Jerome ate $\frac{1}{9}$ of a cake and his sister ate $\frac{1}{2}$ of it. What fraction of the cake was left?

Ans: _____

- 36 Diva paid \$32 for a pair of jeans. Her mother gave her \$20 after that. She had \$57 left. How much did Diva have at first?

Ans: \$ _____

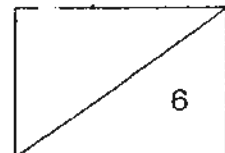

- 37 The figure below is made up of 8 similar squares of (side) 4 cm. What is the area of the figure?

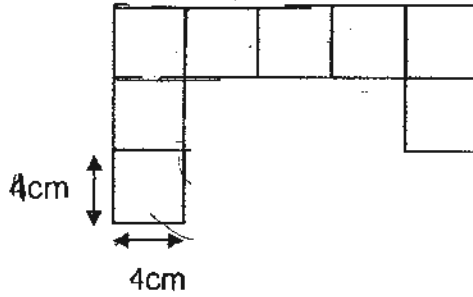

Ans: _____ cm²

- 38 Arrange the fractions in order beginning with the greatest.

Ans: _____

39 $765 - 42 = 800 - \underline{\hspace{2cm}}$

Ans: _____

- 40 Arrange the angles in order beginning with the greatest.

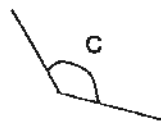
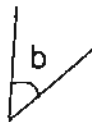
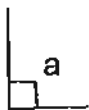

Ans: _____, _____, _____

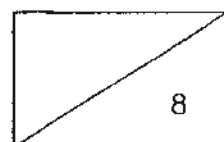

Section C : Long-Answer/Structured Questions

For Questions 41 to 45, show your working clearly in the space below each question and write your answers in the spaces provided.

(20 marks)

41 Josh has 364 marbles and Fizal has 1 036 more marbles than Josh. Muthu has twice the sum of Josh and Fizal's marbles.

- (a) How many marbles does Muthu have?
- (b) How many marbles do they have altogether?

42 There were 123 apples in Box A and 234 apples in Box B. Box C was empty. Some apples were taken out from Box A and Box B to be put into Box C so that all the 3 boxes would have an equal number of apples. How many apples were taken out from Box A and Box B altogether?

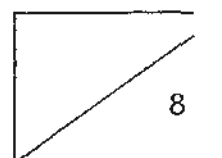

- 43 The table below shows the ending time of the first 4 runners in a marathon. They all started at 8.30 a.m.

	Timing
Runner 1	10.15 a.m.
Runner 2	10.30 a.m.
Runner 3	11.25 a.m.
Runner 4	?

- (a) Which Runner took 2 hours to finish his race?
- (b) At what time did Runner 4 finish his race, if he finished 1 hour and 43 minutes after Runner 1?

-
- 44 Dinesh bought some candies for 7 friends.
He packed 14 candies for each of them.
After packing, he realised that his friends could still get 3 more each,
leaving him with 3 candies. How many candies did he buy?

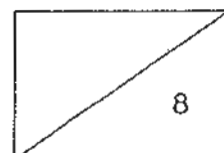

45 Study the figure below.

- (a) What is the perimeter of this figure?
- (b) What is the area of this figure?

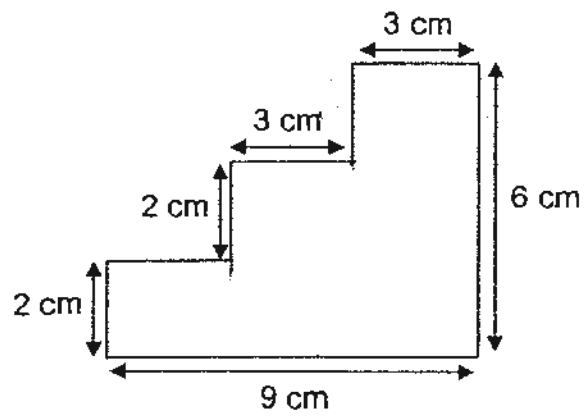

END OF PAPER

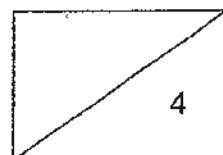

ANSWER SHEET

EXAM PAPER 2010

SCHOOL : RED SWASTIKA PRIMARY
SUBJECT : PRIMARY 3 MATHEMATICS

TERM : SA2

Q1	Q2	Q3	Q4	Q5	Q6	Q7	Q8	Q9	Q10	Q11	Q12	Q13	Q14	Q15	Q16	Q17
3	2	3	1	4	1	1	4	3	1	2	4	4	1	/	3	3

Q18	Q19	Q20
2	1	2

21)7870 22)2hr 25 min 23)7503 24)1m 67cm 25)1450ml

26)141 27)Zoo, Bird park 28)800 29)100 30)1600

31)3000 32)1 33)159 34)6 35)7/18

36)\$69 37)128cm² 38)³/₄, 7/12, 1/6 39)77 40)c,a,b

41)a)364 + 1036 = 1400
1400 + 364 = 1764
1764 x 2 = 3528
b)364 + 1400 + 3528 = 5292

42)123 + 234 = 357
357 ÷ 3 = 119

43)a)10.20 – 8.30 = 2h
Ans: Runner 2
b)10h 15min + 1h 43min = 11h 58min
Ans: 11.58a.m.

44)14 + 3 = 17
17 x 7 = 119
119 + 3 = 122

45)a)9 + 6 + 9 + 6 = 30cm
b)3 x 2 = 6
6 x 2 = 12
9 x 2 = 18
6 + 12 + 18 = 36cm²