

METHODIST GIRLS' SCHOOL (PRIMARY)

Founded in 1887



PRIMARY 4 END-OF-YEAR EXAMINATION 2010 MATHEMATICS BOOKLET A

Total Time: 1 h 45 minutes

INSTRUCTIONS TO CANDIDATES

Do not turn over this page until you are told to do so.
Follow all instructions carefully.
Answer all questions.

Name: _____ ()

Class: Primary 4. _____

Date: 7 Oct 2010

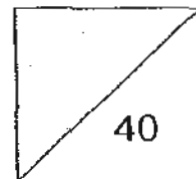

This booklet consists of 10 printed pages including this page.

Section A (40 marks)**Questions 1 to 20 carry 2 marks each.****For each of the following question, four options are given.****One of them is the correct answer.****Make your choice (1, 2, 3, 4). Shade the oval (1, 2, 3, 4) on the Optical Answer Sheet.**

1. In which of the following numbers does the digit 7 stand for 7 000?

~~(1)~~ 23 970 23 970

~~(2)~~ 32 709 32 709

~~(3)~~ 47 990 47 990

~~(4)~~ 74 099 74 099

2. Which of the following are common factors of 16 and 28?

(1) 1 and 3

(2) 2 and 4

(3) 3 and 7

(4) 4 and 7

3. $7.05 = 7 + \frac{5}{\boxed{?}}$

What is the missing number in the box?

(1) 1

(2) 10

(3) 100

(4) 1 000

Go on to the next page

4. What fraction of the shapes in the box are  ?

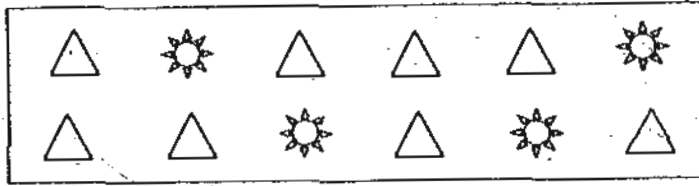

- (1) $\frac{1}{4}$
- (2) $\frac{1}{3}$
- (3) $\frac{1}{2}$
- (4) $\frac{3}{4}$
5. Arrange the following fractions from the greatest to the smallest.

$$\frac{1}{2}, \frac{3}{4}, \frac{5}{8}$$

- | | (greatest) | | (smallest) |
|-----|---------------|---------------|---------------|
| (1) | $\frac{3}{4}$ | $\frac{1}{2}$ | $\frac{5}{8}$ |
| (2) | $\frac{1}{2}$ | $\frac{5}{8}$ | $\frac{3}{4}$ |
| (3) | $\frac{3}{4}$ | $\frac{5}{8}$ | $\frac{1}{2}$ |
| (4) | $\frac{1}{2}$ | $\frac{3}{4}$ | $\frac{5}{8}$ |

Go on to the next page

6. In the number 35.201, the digit _____ is in the tenths place.

(1) 1

(2) 2

(3) 3

(4) 0

7. Which of the following shapes cannot tessellate?

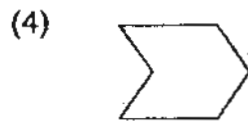
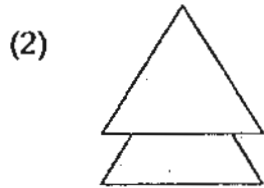
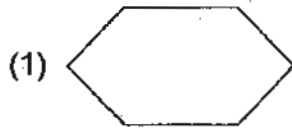

8. Tammy had \$12 more than Jenny. After their father gave each of them \$7, both of them had \$60 altogether. How much money did Jenny have at first?

(1) \$17

(2) \$24

(3) \$34

(4) \$48

Go on to the next page

Study the table carefully and answer Questions 9 and 10.

Melissa and Judy baked some blueberry muffins and chocolate muffins for their class party.

The table below shows the number of muffins baked by each girl.

	Blueberry muffins	Chocolate muffins
Melissa	20	?
Judy	?	36
Total number of muffins	50	70

9. How many blueberry muffins did Judy bake?

- (1) 20
- (2) 30
- (3) 66
- (4) 100

10. How many muffins did Melissa bake altogether?

- (1) 30
- (2) 34
- (3) 54
- (4) 120

Go on to the next page

11. How many letters in the word below have parallel lines?

H O T E L

- (1) 1
- (2) 2
- (3) 3
- (4) 4

12. It is 9.30 a.m. now.

What time would the clock show if the minute hand made a $\frac{3}{4}$ -turn anti-clockwise?

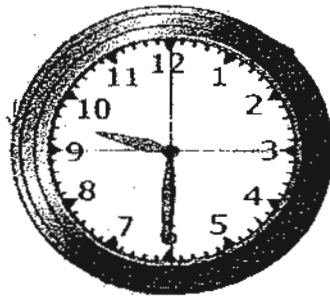

- (1) 8.45 a.m.
- (2) 10.15 a.m.
- (3) 12.30 p.m.
- (4) 6.30 p.m.

Go on to the next page

13. What is the value of $\angle CBD$?

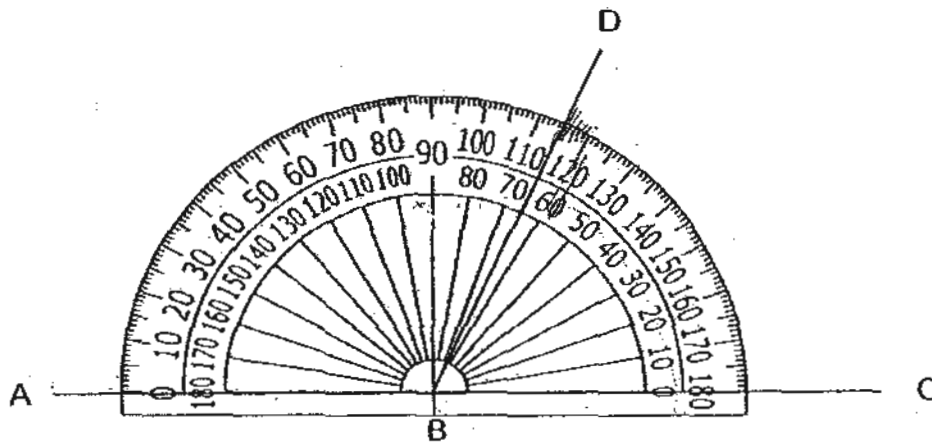

- (1) 65°
 - (2) 75°
 - (3) 115°
 - (4) 125°
14. What is the value of $12.69 + 2.3$?
Round off your answer to one decimal place.

- (1) 14.0
- (2) 14.7
- (3) 14.9
- (4) 15.0

Go on to the next page

15. $5.03 \times 4 =$ _____

- (1) 20.12
- (2) 20.43
- (3) 21.12
- (4) 21.43

Study the diagram below and answer Question 16.

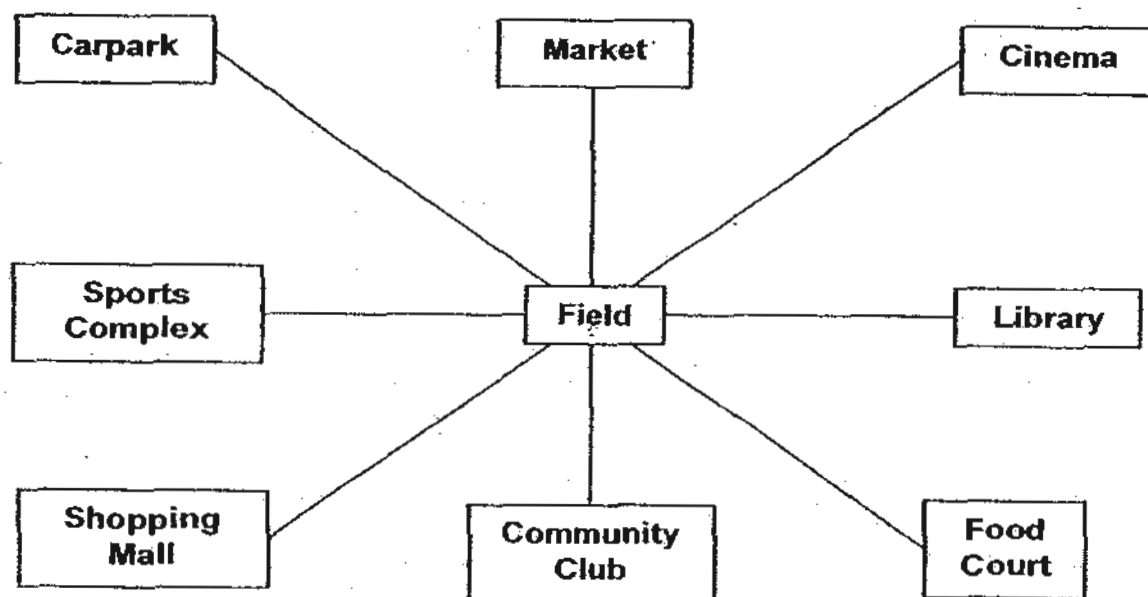

Pauline is standing in the middle of the field. If Pauline turns 135° clockwise, she will be facing the library. Where is she facing now?

16.
 - (1) Library
 - (2) Cinema
 - (3) Car park
 - (4) Shopping mall

Go on to the next page

17. The diagram below is not drawn to scale. ABCD is a rectangle. Find $\angle y$.

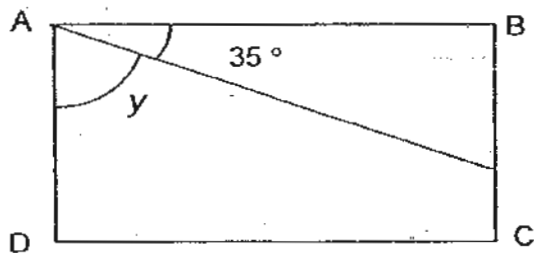

- (1) 45°
(2) 55°
(3) 65°
(4) 75°
18. How many lines of symmetry are there in the figure below?

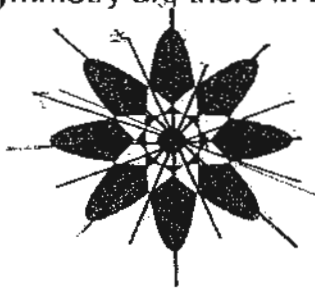

- (1) 0
(2) 2
(3) 8
(4) 4

Go on to the next page

19. All lines in the figure below meet at right angles.

If $AB = CD = EF = 6$ cm and $BC = DE = 4$ cm, find the area of the figure.

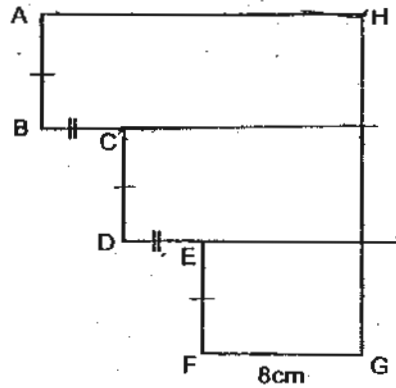

- (1) 168 cm^2
 (2) 216 cm^2
 (3) 288 cm^2
 (4) 316 cm^2
20. The figure below is made up of two identical squares.
 The perimeter of one square is 36 cm, what is the area of the whole figure?

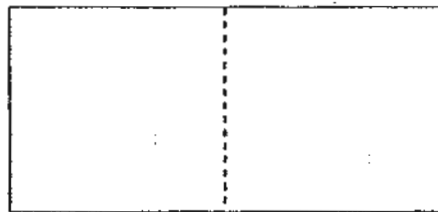

- (1) 54 cm^2
 (2) 72 cm^2
 (3) 162 cm^2
 (4) $1\,296 \text{ cm}^2$

Go on to the next page

METHODIST GIRLS' SCHOOL (PRIMARY)

Founded in 1887



PRIMARY 4 END-OF-YEAR EXAMINATION 2010 MATHEMATICS BOOKLET B

Total Time: 1 h 45 minutes

INSTRUCTIONS TO CANDIDATES

Do not turn over this page until you are told to do so.
Follow all instructions carefully.
Answer all questions.

Name: _____ ()

Class: Primary 4. _____

Date: 7 Oct 2010

BOOKLET A	40
BOOKLET B	60
TOTAL	100

This booklet consists of 11 printed pages including this page.

Section B (40 marks)**Questions 21 to 40 carry 2 marks each.****Write your answers in the space provided.****For questions which require units, give your answers in the units stated.**

21. Fill in the blank with the correct number in the number pattern below.

600 , 475 , 350 , _____ , 100

22. Round off 10 458 to the nearest hundred.

23. $4256 \div 7 =$ _____

24. Write $\frac{26}{6}$ as a mixed number in its simplest form.

Go on to the next page

25. $\frac{4}{12} = \frac{\boxed{}}{9}$

What is the missing number in the box?

26. Jane spent $\frac{1}{5}$ of her pocket money on food, $\frac{7}{10}$ of it on stationery and saved the rest. If she saved \$2.50, how much was her pocket money?

27. Write 6 hundredths as a decimal.

28. $8.5 - 0.86 = \underline{\hspace{2cm}}$

Go on to the next page

29. Qing Ling attended a musical at 7.45 p.m.
The musical lasted 90 minutes.
At what time did the musical end?

p.m.

30. When it is 09 20 in Singapore, it is 08 20 in Bangkok. A plane took off from Singapore at 10 00 for Bangkok. The flight took 1h 45 mins.
What time did the plane land in Bangkok? Give your answer in the 24-h clock.

31. One of the lines in the figure is parallel to BE.
Which line is parallel to BE?

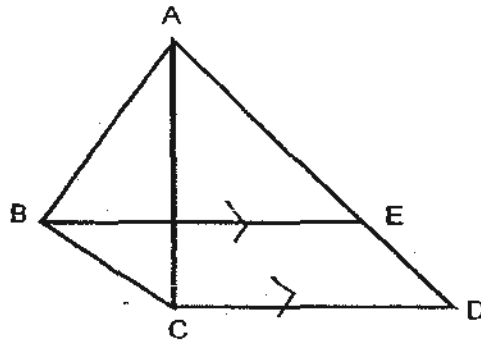

Go on to the next page

32. In the figure below, which angle is greater than a right angle?

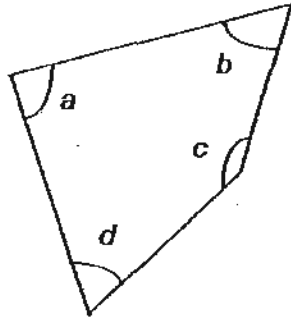

Look at the figure below and answer Questions 33 and 34.

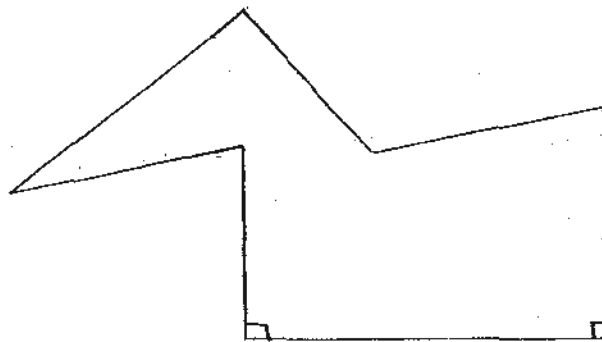

33. How many pairs of parallel lines are there in the figure?

34. How many right angles are there in the figure?

Go on to the next page

Study the graph below carefully and answer Questions 35 and 36

The graph below shows the different ways the pupils from Blackmore Primary travel to school.

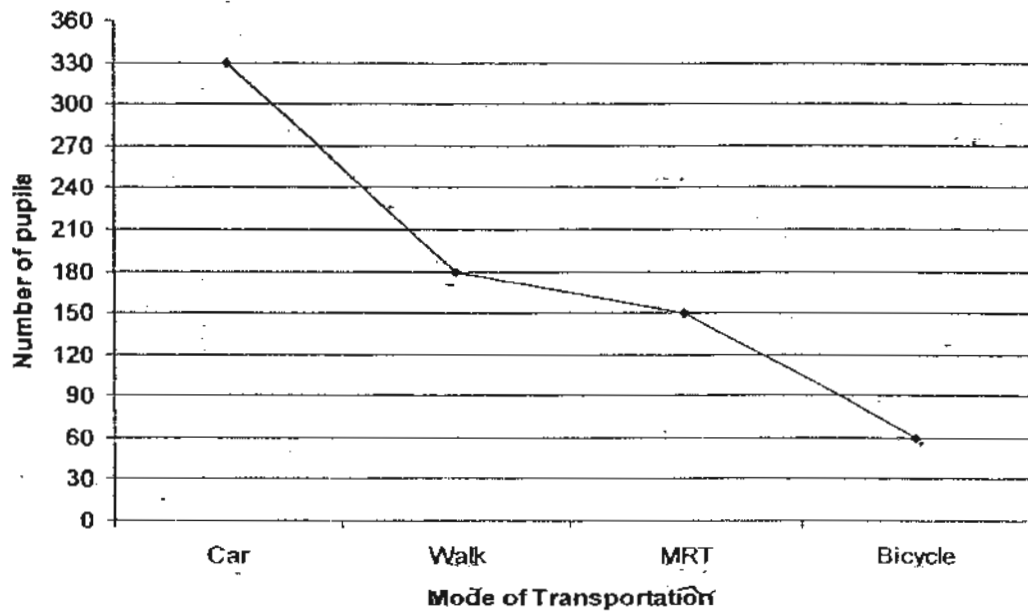

35. How many more pupils travel to school by car than those who travel by MRT and bicycle?

36. On rainy days, instead of cycling to school, half of these pupils will walk to school.
What would be the total number of pupils walking to school on rainy days?

Go on to the next page

The figure below is not drawn to scale. It is made up of 2 similar rectangles. Study the figure below and answer Questions 37 and 38.

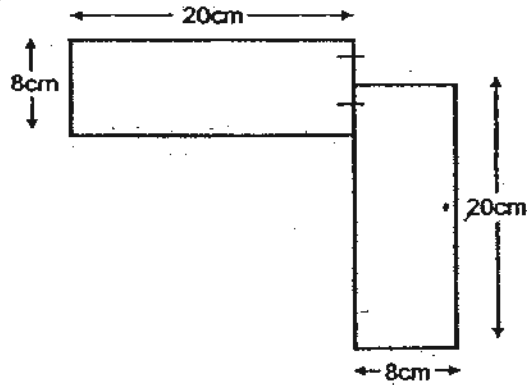

37. Find the perimeter of the whole figure.

 cm

38. A square tile of 9 cm^2 is to be laid on the whole figure. How many of such tiles are needed?

Go on to the next page

39. Complete the figure below using the dotted line as the line of symmetry.

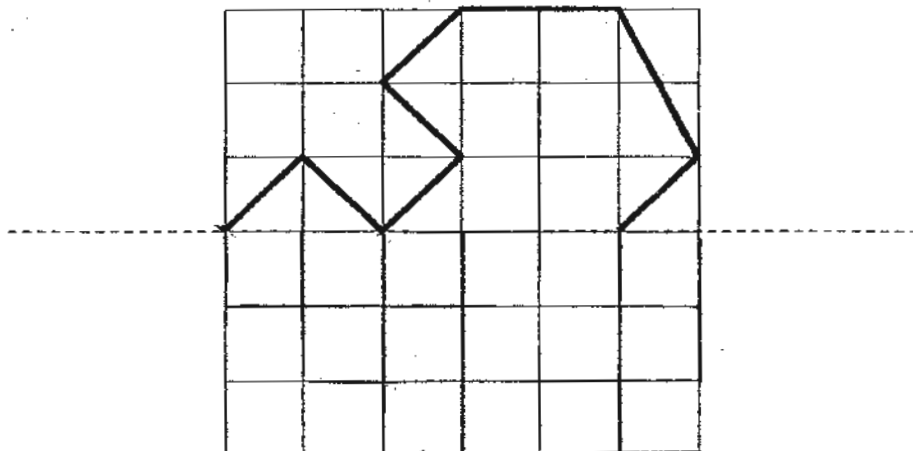

40. Extend the tessellation by 4 more unit shapes.

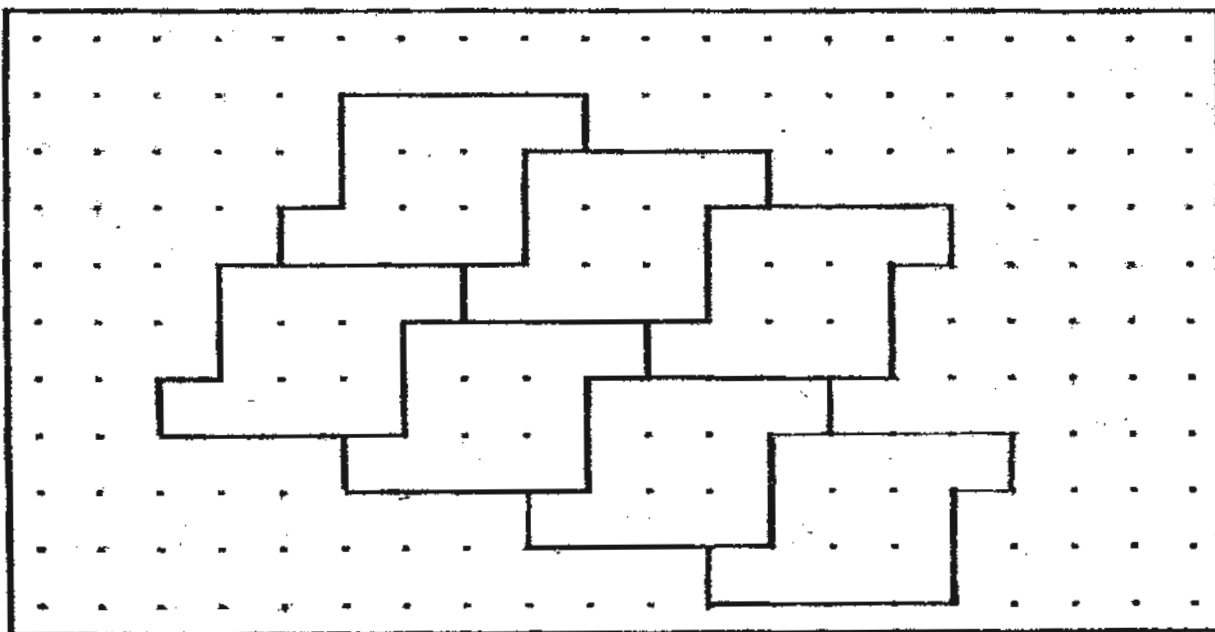

Go on to the next page

Section C (20 marks)**Questions 41 to 45 carry 4 marks each.****Show your working clearly in the space provided for each question and write your answers in the space provided.****The number of marks available is shown in brackets [] at the end of each question or part-question.**

41. A basket contained 244 red, blue and green bean bags. There were 3 times as many blue bean bags as red bean bags. There were 16 fewer green bean bags than red bean bags. How many red bean bags were there in the basket?

Ans: _____ [4]

42. Rosa spent $\frac{1}{6}$ of her money on a skirt and $\frac{3}{5}$ of the remaining money on a dress. The dress cost \$90 more than the skirt. How much money did she have at first?

Ans: _____ [4]

Go on to the next page

43. A square plot of garden has a length of 3 m.
Mrs Chan makes a path of width 1.5 m around her garden as shown in the diagram below.
- Find the length of AH.
 - Find the area of the shaded path.

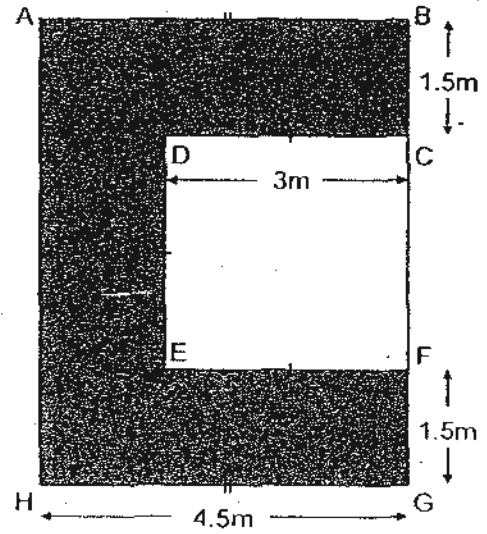

Ans : [a] _____ [2m]

[b] _____ [2m]

Go on to the next page

44. At a party, every girl was given 4 bars of chocolate and every boy was given 5 bars of chocolate. There were 5 times as many boys as girls at the party. Given that a total of 232 bars of chocolate were given out, how many boys were at the party?

Ans: _____ [4]

45. Tin A contains some 20-cents coins and Tin B contains some 50-cents coins. There are 9 more coins in Tin A than in Tin B. The amount of money in Tin A is \$2.70 less than that in Tin B. How many 50-cents coins are there in Tin B?

Ans: _____ [4]

END OF PAPER

ANSWER SHEET

EXAM PAPER 2010

**SCHOOL : MGS PRIMARY
SUBJECT : PRIMARY 4 MATHEMATICS**

TERM : SA2

Q1	Q2	Q3	Q4	Q5	Q6	Q7	Q8	Q9	Q10	Q11	Q12	Q13	Q14	Q15	Q16	Q17
3	2	3	2	3	2	2	1	2	3	2	1	1	4	1	3	2

Q18	Q19	Q20
3	2	3

- 21)225 22)10500 23)608 24) $4\frac{1}{3}$ 25)3
- 26)\$25 27)0.06 28)7.64 29)9.15p.m. 30)1045
- 31)CD//BE 32) $\angle C$ 33)2 34)2 35)120 more
- 36)210 37)104cm 38)24 39)

40)

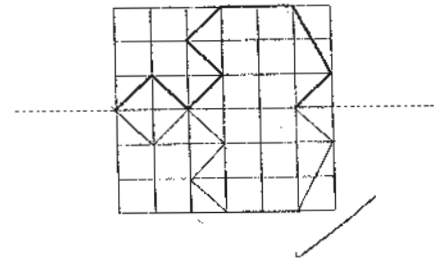
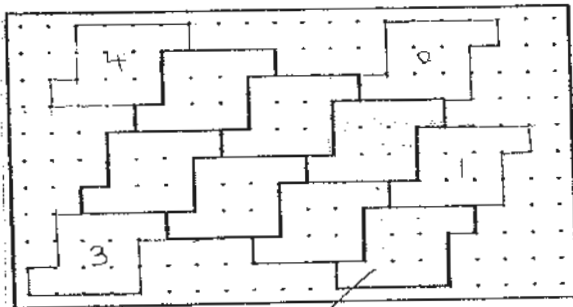

- 41) $244 + 16 = 260$
 $260 \div 5 = 52$
There were 52 red bean bags.

- 42) $2u \rightarrow 90$
 $1u \rightarrow 90 \div 2 = 45$
 $6u \rightarrow 45 \times 6 = \270
She had \$270 at first.

- 44)There were 40 boys.

- 43) $1.5 + 1.5 = 3$
 $3 + 3 = 6$
a)The length of AH is 6cm

- $3 \times 3 = 9$
 $4.5 \times 6 = 27$
 $27 - 9 = 18$
b)The area of the shaded path is 18m²

- 45)There are 15 50 cents coins in TinB