



NAN HUA PRIMARY SCHOOL
PRIMARY FOUR SEMESTRAL ASSESSMENT 2 - 2010

MATHEMATICS

Duration : 1 h 45 min

INSTRUCTIONS TO CANDIDATES

1. Write your name, register number and class in the blanks provided.
2. Do not turn over this page until you are told to do so.
3. Follow all instructions carefully.
4. Answer all questions.
5. Write your answers in this booklet.

Marks Obtained

Total Marks:

	/ 100
--	-------

Name : _____ ()

Class : P 4 _____

Date : 27 Oct 2010

Parent's Signature : _____

Section A: Multiple Choice Questions (20 × 2 marks)

Questions 1 to 20 carry 2 marks each.

Of the 4 options given, only one is correct. Choose the correct answer (1, 2, 3 or 4) and shade the correct oval on the Optical Answer Sheet (OAS).

1. 12 thousands and 3 tens is the same as _____.
- (1) 1203
(2) 1230
(3) 12 003
(4) 12 030 ()
2. Which of the following numbers when rounded off to the nearest ten becomes 45 800?
- (1) 45 777
(2) 45 796
(3) 45 809
(4) 45 883 ()
3. Which one of the following is a multiple of both 4 and 6 ?
- (1) 10
(2) 12
(3) 28
(4) 32 ()
4. What is the remainder when 3 453 is divided by 7?
- (1) 1
(2) 2
(3) 3
(4) 4 ()

5. Find the value of $\frac{1}{3} + \frac{1}{6}$.

(1) $\frac{1}{2}$

(2) $\frac{2}{9}$

(3) $\frac{1}{18}$

(4) $\frac{2}{3}$

()

6. How many one-fifths are there in 2 wholes?

(1) $2\frac{1}{2}$

(2) $\frac{2}{5}$

(3) 5

(4) 10

()

7. What fraction of the figure is shaded?

(1) $\frac{3}{8}$

(2) $\frac{1}{2}$

(3) $\frac{1}{3}$

(4) $\frac{2}{3}$

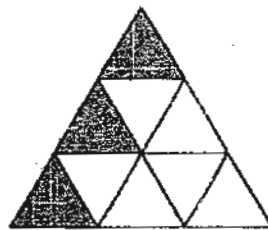

()

8. Which one of the following fractions is greater than half?

~~(A)~~ $\frac{1}{3}$

~~(B)~~ $\frac{3}{5}$

~~(C)~~ $\frac{4}{9}$

~~(D)~~ $\frac{5}{11}$

()

9. Express 0.04 as a fraction in its simplest form.

(1) $\frac{1}{4}$

(2) $\frac{2}{5}$

(3) $\frac{1}{10}$

(4) $\frac{1}{25}$

()

10. The pupils in Primary 4A want to make a banner that is 1 m 25 cm long. They have a 3 m long cloth. How much cloth do they need to cut away to make the banner?

(1) 95 cm

(2) 122 cm

(3) 175 cm

(4) 1975 cm

()

11. Which one of the following unit shapes cannot tessellate?

(1)

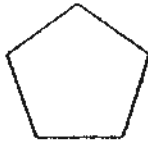

(2)

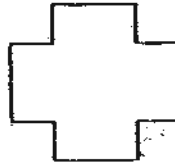

(3)



(4)



()

12. One of the lines in the figure given below is perpendicular to DC. Which line is perpendicular to DC?

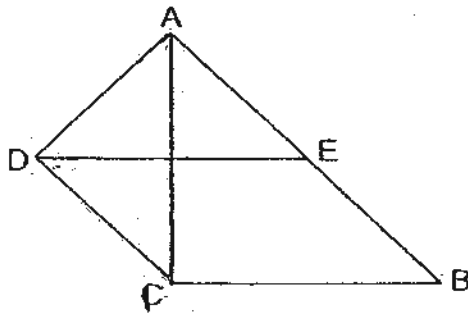

- (1) AB
- (2) AC
- (3) AD
- (4) DE

()

13. Which one of the following has the greatest value?

- (1) 20 five-cent coins
- (2) 16 ten-cent coins
- (3) 3 fifty-cent coins
- (4) 7 twenty-cent coins

()

14. Joshua is facing his home. He makes a $\frac{1}{4}$ - turn in a clockwise direction.
He is now facing the _____.

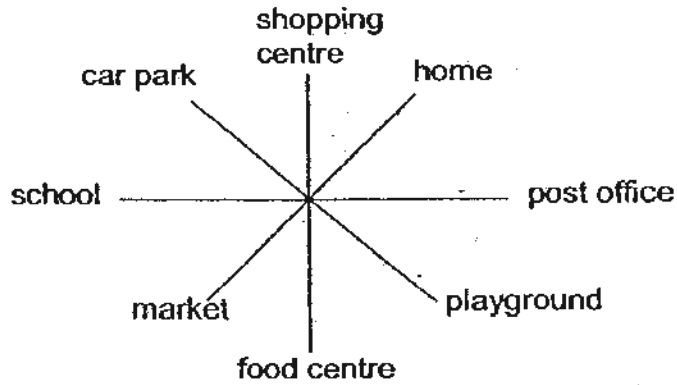

- (1) shopping centre
(2) playground
(3) post office
(4) car park

()

15. The figure below, not drawn to scale, is made up of a big rectangle and a small square of side 8 cm. Find the length of AB.

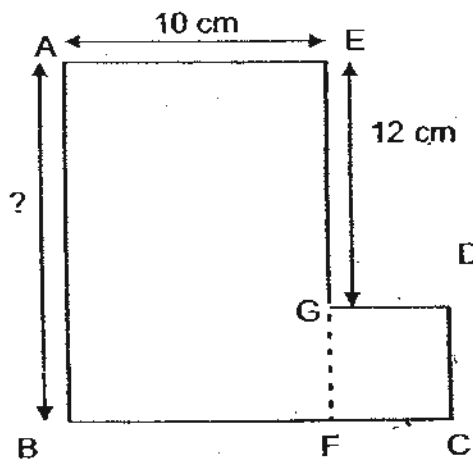

- (1) 18 cm
(2) 20 cm
(3) 22 cm
(4) 30 cm

()

16. May studies in the morning session. Every day, she takes 1 h 15 min to go home from school. She reaches home at 1.10 p.m. daily. What time does May leave school daily?

- (1) 2.25 a.m.
- (2) 2.25 p.m.
- (3) 11.55 a.m.
- (4) 11.55 p.m.

()

17. Serene made a pattern using 4 shapes. The pattern is shown below. Which of the following is the 66th shape of the pattern?



- (1)
- (2)
- (3)
- (4)

()

18. What is the area of the rectangle ABCD below?

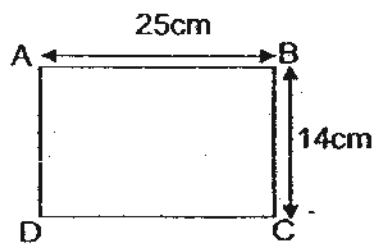

- (1) 39 cm²
- (2) 78 cm²
- (3) 350 cm²
- (4) 700 cm²

()

19. A piece of wire is used to bend a square of side 12 cm. It is then straightened and used to bend a rectangle of length 17 cm. What is the breadth of the rectangle?

- (1) 5 cm
- (2) 7 cm
- (3) 14 cm
- (4) 31 cm

()

20. A large piece of rectangular cardboard has a length of 70 cm and a width of 40 cm.

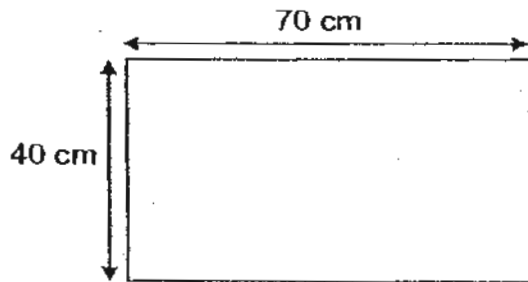

Yasmine wants to cut out squares of sides 3 cm from the cardboard. What is the maximum number of squares that Yasmine can cut from the cardboard?

- (1) 299
- (2) 311
- (3) 2691
- (4) 2800

()

Section B: Open-ended Questions (20 × 2 marks)

Questions 21 to 40 carry 2 marks each.

Write out the correct answers for the following questions in the boxes provided.
Show your workings clearly and give your answers in the units provided.

21. Fill in the box with the correct number in the number pattern below.

650 , 635 , 620 , , 590

22. What is the first common multiple of 3 and 9?

23. $7\frac{4}{9} = \frac{\square}{9}$

What is the missing number in the box?

24. Arrange the following numbers in order from the greatest to the smallest.

0.641 , 9.3 , 0.903 , 0.045

_____ , _____ , _____ , _____
greatest smallest

25. Express $6\frac{1}{20}$ as a decimal.

26. $8.3 - 0.92 =$ _____

27. The square ABCD given below, is not drawn to scale. Find the value of $\angle x$.

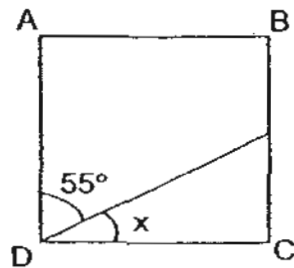
°

28. Samy has \$3.20. He has enough money to pay for $\frac{2}{9}$ of the cost of a book. How much more money does he need?

\$

29. Write the fraction represented by A.

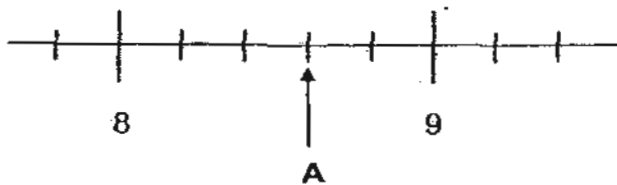

30. Shade two more boxes in the figure below such that line AB is the line of symmetry of the figure.

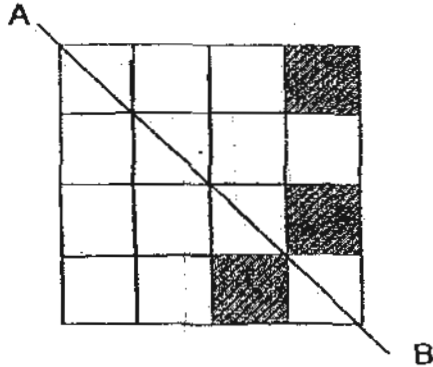

31. Fruits are sold in packs of 3 apples for \$1 and cartons of 5 oranges for \$1.50. Mrs Ang has \$5. What is the maximum number of fruits that she can get?

	fruits
--	--------

32. Mr Smith took a flight from Tokyo at 10.30 p.m. He reached Singapore at 7.15 a.m. How long was the flight from Tokyo to Singapore? Give your answer in hours and minutes.

h	min
---	-----

33. To bake a cake, Mrs Tan mixes 200 g of sugar and 650 g of flour with 185 g of water. What is the total mass of the ingredients? Give your answer in kilograms and grams.

kg	g
----	---

34. $\frac{5}{8}$ of a number is 25. What is twice the number?

The graph below shows the amount of money four children saved in a month. Study the graph below carefully and use it to answer questions 35 and 36.

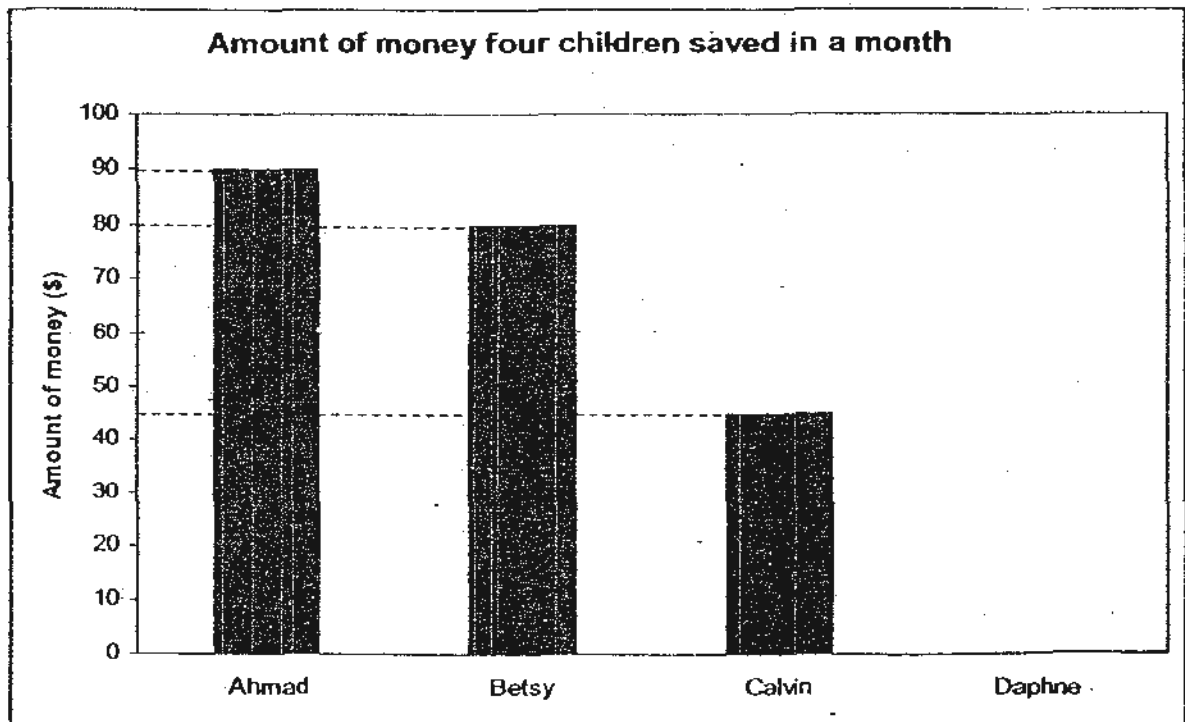

35. Calvin saves half as much as _____.

36. The four children saved a total of \$275. Draw a bar to represent Daphne's savings in the graph given above.

37. Hilda multiplied her age by 4 and added 18 to the product. The answer was 90.
How old was Hilda?

years old

38. Weiming has a square piece of paper with sides 6 cm.
He cuts off a 1-cm square from each of the four corners.
What is the perimeter of the remaining piece of paper?

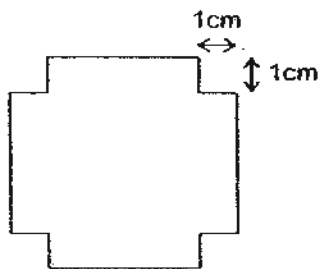

cm

39. The cost of fencing a garden is \$10 per metre. Mr Loh paid \$480 to fence his square garden. What is the area of his garden?

m²

40. The figure below shows part of a tessellation.

(a) Shade the unit shape of the tessellation given.

(b) Extend the tessellation by drawing two more complete units shapes in the space provided within the box.

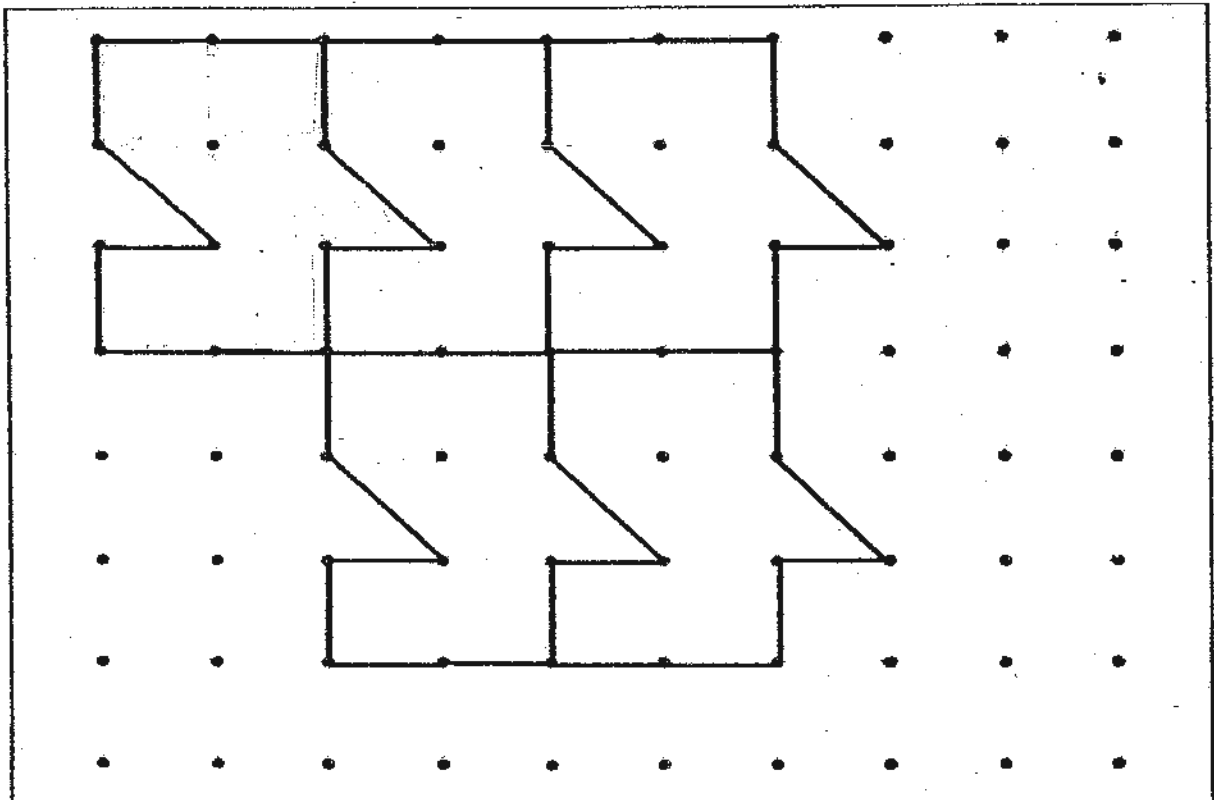

Section C (5 × 4 marks)

For each of the following questions, show your workings and mathematical statements in the space below each question. Write your answer in the answer space provided.

41. A bakery baked 5 640 tarts a day. The tarts were packed in boxes of 6 and sold at \$5 per box. At the end of the day, 10 boxes were left. How much money was collected from the sale of the tarts?

42. Mary has $\frac{3}{8}\ell$ of orange juice. Jane has $\frac{1}{4}\ell$ more orange juice than Mary.
Susan has $\frac{1}{2}\ell$ less orange juice than Jane.
How much orange juice does Susan have?

43. A class has an equal number of boys and girls. $\frac{1}{2}$ of the boys and 15 girls do not wear glasses. 12 pupils in the class wear glasses. How many pupils are there in the class?

44. At a farm, the number of chickens is twice the number of cows. The number of ducks is thrice the number of chickens. After 90 ducks are sold, the number of ducks is the same as the number of cows. How many animals are left in the farm?

45. The figure below is formed by overlapping 3 identical squares of sides 10 cm. Find the area of the figure.

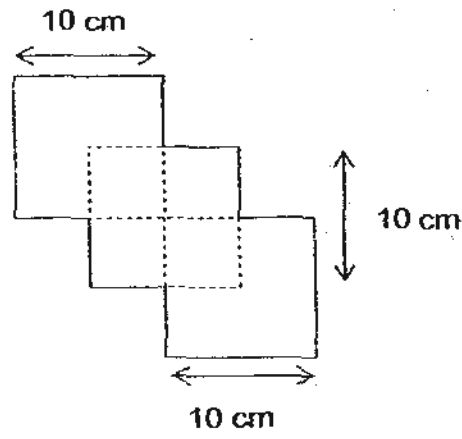

End of Paper

ANSWER SHEET

EXAM PAPER 2010

SCHOOL : NAN HUA PRIMARY
SUBJECT : PRIMARY 4 MATHEMATICS

TERM : SA2

Q1	Q2	Q3	Q4	Q5	Q6	Q7	Q8	Q9	Q10	Q11	Q12	Q13	Q14	Q15	Q16	Q17
4	2	2	2	1	4	3	2	4	3	1	3	2	2	2	3	2

Q18	Q19	Q20
3	2	1

21)605 22)9 23)67 24)9.3, 0.903, 0.641, 0.045 25)6.05

26)7.38 27)35° 28)\$11.20 29)8³/₅ 30)

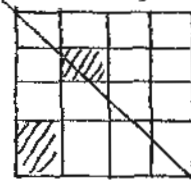

31)16 32)8h 45min 33)1kg 35g

34)80 35)Ahmad 36)Daphne----60

37)18 38)24 39)144 40)

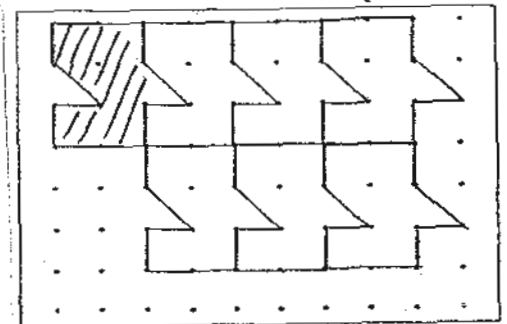

41)6 tarts→1 box

$$5640 \text{ tarts} \rightarrow 5640 \div 6 = 940$$

$$\text{No of boxes sold} \rightarrow 940 - 10 = 930$$

$$\text{Money collect} \rightarrow 930 \times 5 = \$4650$$

The amount of money collected from the sale of the tarts is \$4650.

42)Mary→3/8

$$\text{Jane} \rightarrow 3/8 + 1/4 = 5/8$$

$$\text{Susan } 5/8 - 1/2 = 1/8$$

Susan has 1/8L of orange.

43)wears→12

$$3 \text{ units} \rightarrow 12 + 15 = 27$$

$$1 \text{ unit} = 27 \div 3 = 9$$

$$4 \text{ units} \rightarrow 4 \times 9 = 36$$

There are 36 children in the class.

$$44)90 \div 5 = 18$$

$$18 \times 4 = 72$$

72 animals are left in the farm.

$$45)1 \text{ square} = 10 \times 10 = 100$$

$$\text{Area of } 1/2 \text{ square} = 100/2 = 50$$

$$\text{Area of figure} = (100 + 100 + 50)$$

$$= 250 \text{ cm}^2$$

The area of the figure is 250cm²