



NANYANG PRIMARY SCHOOL
SECOND SEMESTRAL EXAMINATION
2010

PRIMARY 5
MATHEMATICS

PAPER 1

DURATION: 50 MINUTES

Booklet A	/ 20
Booklet B	/ 20

Paper 1 Total: / 40

Name: _____ ()

Class: Primary 5 ()

Date: _____

Parent's Signature: _____

DO NOT OPEN THIS BOOKLET UNTIL YOU ARE TOLD TO DO SO.

FOLLOW ALL INSTRUCTIONS CAREFULLY.

ANSWER ALL QUESTIONS.

YOU ARE NOT ALLOWED TO USE A CALCULATOR.

PAPER 1 (BOOKLET A)

Questions 1 to 10 carry 1 mark each. Questions 11 to 15 carry 2 marks each. For each question, four options are given. One of them is the correct answer. Make your choice (1, 2, 3 or 4). Shade the oval (1, 2, 3 or 4) on the Optical Answer Sheet.

(20 marks)

1 Find the value of $60 - 6 \times 7 + 12 \div 3$.

- (1) 10
- (2) 22
- (3) 130
- (4) 382

2 Jason sold $\frac{2}{9}$ kg of rice. Anand sold $1\frac{1}{5}$ times as much rice as Jason. How many kilograms of rice did Anand sell?

- (1) $\frac{1}{15}$
- (2) $\frac{4}{15}$
- (3) $\frac{4}{7}$
- (4) $\frac{5}{27}$

- 3 A tap can fill a tank with $\frac{6}{7}$ l of water in 3 hours at a constant rate.
How many litres of water can the tap fill the tank in one hour?

(1) $\frac{2}{7}$

(2) $\frac{7}{18}$

(3) $2\frac{4}{7}$

(4) $3\frac{1}{2}$

- 4 In the diagram below, $BD \perp AC$ and $AE \perp EC$. ABC and EDC are straight lines. Which of the following are the bases of Triangle ADC if BD and AE are the heights respectively?

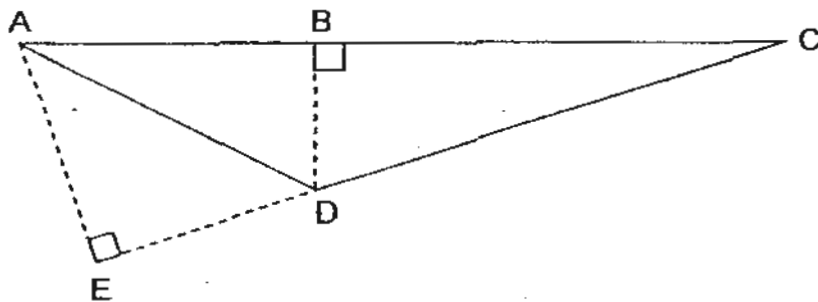

- (1) AC and DC
(2) BC and DC
(3) AC and EC
(4) BC and EC

5 $9 : 15 = 6 : \square$

What is the missing number in the box?

- (1) 5
- (2) 7
- (3) 10
- (4) 12

6 What is the value of $945 \div 90$?

- (1) 105
- (2) 15
- (3) 10.5
- (4) 1.5

7 In a class of 40 pupils, there are 24 pupils who wear glasses. What percentage of the pupils in the class **do not** wear glasses?

- (1) 16%
- (2) 24%
- (3) 40%
- (4) 60%

- 8 Which of the following triangle(s) is/are isosceles triangle(s)?
(The triangles are not drawn to scale.)

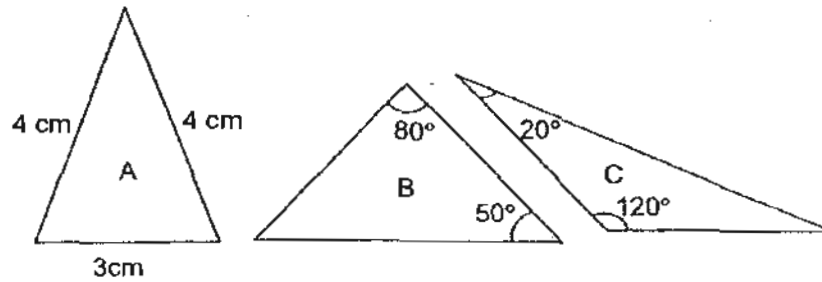

- (1) A only
 (2) A and B only
 (3) A and C only
 (4) B and C only
- 9 Which of the following figures is/are (a) trapezium(s)?

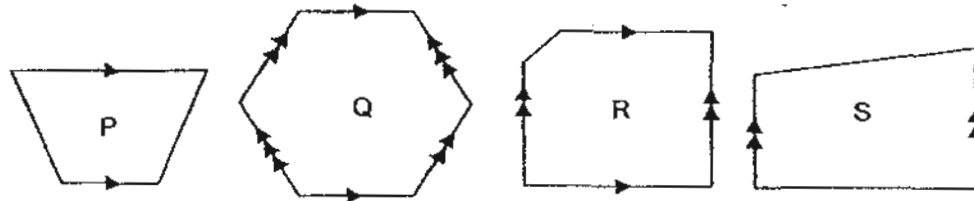

- (1) P only
 (2) P and S only
 (3) P, R and S only
 (4) P, Q, R and S

- 10 The solid below is made up of 2-cm cubes. What is the volume of the solid?

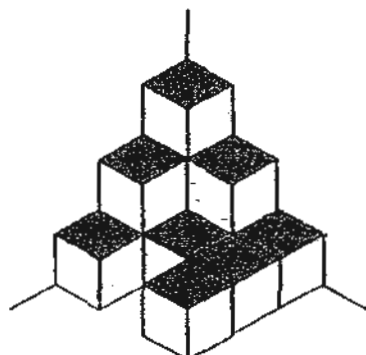

- (1) 12 cm^3
(2) 24 cm^3
(3) 48 cm^3
(4) 96 cm^3
- 11 The total cost of a laptop and a DVD player is \$3600. The cost of the DVD player is 20% of the cost of the laptop. How much does the laptop cost?

- (1) \$600
(2) \$720
(3) \$2880
(4) \$3000

12 A tank was initially filled with 1.25 l of water. A tap was turned on to add water into the tank at a constant rate from 2.30 p.m. to 3.00 p.m. If the tank contained 3.75 l of water at 3.00 p.m. and it was still a quarter empty, at what time would the tank be completely filled?

(1) 3.10 p.m.

(2) 3.15 p.m.

(3) 3.30 p.m.

(4) 7.30 p.m.

13 The average mass of 3 children was 40 kg. The average mass of another 5 children was 48 kg. What was the average mass of the 8 children?

(1) 11 kg

(2) 44 kg

(3) 45 kg

(4) 64 kg

14 There are 60% as many blueberry muffins as banana muffins and 20% more chocolate muffins than the blueberry muffins. What is the ratio of the number of banana muffins to the number of chocolate muffins?

(1) 5 : 1

(2) 5 : 4

(3) 25 : 3

(4) 25 : 18

15 The ratio of the length of a cuboid to its breadth is 3 : 2. The base area of the cuboid is 24 m^2 . Find the volume of the cuboid if the ratio of its length to its height is 1 : 2.

(1) 36 m^3

(2) 48 m^3

(3) 144 m^3

(4) 288 m^3

Name: _____ () Class: Pr 5 ()

P5 SA2 2010

PAPER 1 (BOOKLET B)

Questions 16 to 25 carry 1 mark each. Write your answers in the spaces provided. For questions which require units, give your answers in the units stated.

(10 marks)

16 Find the value of $20 \times (6 + 12) - 15 \div 3$.

Ans: _____

17 Shu Xian and Sheema shared a pizza. Shu Xian ate $\frac{3}{8}$ of the pizza while Sheema ate $\frac{1}{6}$ of it. What fraction of the pizza was left?

Ans: _____

- 18 Jun Xi has 27 jelly beans. En Xi has 12 more jelly beans than Jun Xi. What is the ratio of the number of jelly beans En Xi has to the total number of jelly beans? Express your answer in its simplest form.

Ans: _____

- 19 Find the sum of 4.531 and 5.268.
Round off the answer to 2 decimal places.

Ans: _____

- 20 Express $\frac{5}{8}$ as a percentage.

Ans: _____ %

- 21 Given that $\angle a = 80^\circ$ and $\angle b = 45^\circ$, find $\angle c$.

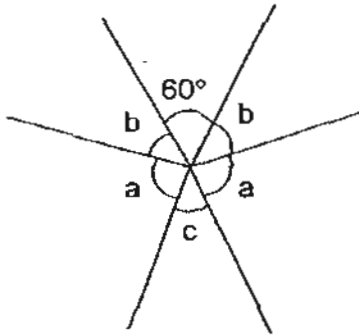

Ans: _____^o

- 22 PXQ and YXZ are straight lines. Find $\angle PXY$.

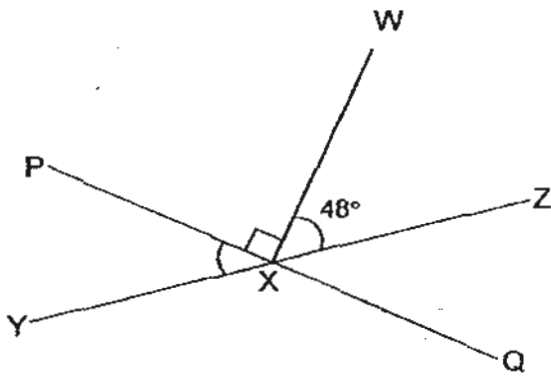

Ans: _____^o

- 23 Given that the following figure is a rhombus, not drawn to scale, find $\angle f$.

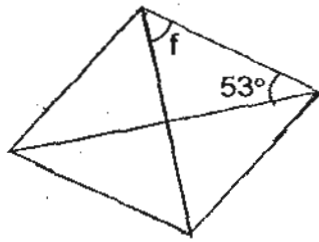

Ans: _____ °

- 24 Find the missing number in the following number pattern.

2, 4, 8, 10, 20, 22, _____, 46

Ans: _____

- 25 A cuboid, with a square base, has a height of 20 cm. If the ratio of its length to its height is 3 : 4, what is its volume?

Ans: _____ cm³

Questions 26 to 30 carry 2 marks each. Show your working clearly in the space provided for each question and write your answers in the spaces provided. For questions which require units, give your answers in the units stated.

(10 marks)

26 If $\frac{2}{7}$ of a number is 144, what is $\frac{1}{3}$ of the number?

Ans: _____

27 The ratio of the area of Square X to the area of Square Y is 4 : 9. What is the ratio of the length of Square X to the perimeter of Square Y? Express your answer in its simplest form.

Ans: _____

- 28 What is the minimum number of unit cubes to be added to the solid below to form a bigger cube?

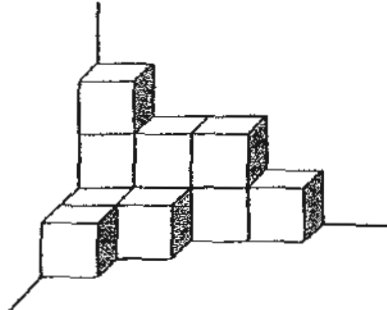

Ans: _____

- 29 Lili bought some table lamps and the average cost of the lamps was \$52. When she bought another table lamp which cost \$70, the average cost then became \$54. What was the total number of table lamps she had in the end?

Ans: _____

- 30 Cain and Abel had an equal number of sweets at first. After Cain gave away 18 sweets and Abel bought another 12 sweets, Abel had thrice as many sweets as Cain. Find the number of sweets Cain had at first.

Ans: _____

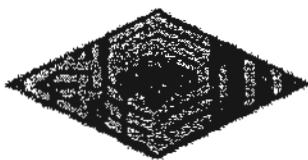

NANYANG PRIMARY SCHOOL
SECOND SEMESTRAL EXAMINATION
2010

PRIMARY 5
MATHEMATICS
PAPER 2

DURATION: 1 HOUR 40 MINUTES

Paper 2 Total	/ 60
GRAND TOTAL	/ 100

Name: _____ ()

Class: Primary 5 ()

Date: _____

Parent's Signature: _____

DO NOT OPEN THIS BOOKLET UNTIL YOU ARE TOLD TO DO SO.

FOLLOW ALL INSTRUCTIONS CAREFULLY.

ANSWER ALL QUESTIONS.

YOU ARE ALLOWED TO USE A CALCULATOR.

PAPER 2

Questions 1 to 5 carry 2 marks each. Show your working clearly in the space provided for each question and write your answers in the spaces provided. For questions which require units, give your answers in the units stated.

(10 marks)

- 1 Mr Zeus is 35 years old and his son is 5 years old now. In how many years' time will he be 4 times as old as his son?

Ans: _____

- 2 The ratio of the number of marbles Crystal had to the number of marbles Don had was 1 : 8. After Don gave Crystal 35 marbles, the ratio became 2 : 1. Find the number of marbles Crystal had in the end.

Ans: _____

- 3 A crate weighs $25\frac{1}{2}$ kg when it is filled with Metal A. The same crate weighs $66\frac{3}{5}$ kg when it is filled with Metal B. Metal B is thrice as heavy as Metal A. What is the mass of the empty crate?

Ans: _____ kg

- 4 In the figure below, not drawn to scale, XY and PQ are straight lines. If $\angle e$ is 7 times the size of $\angle d$, find $\angle d$.

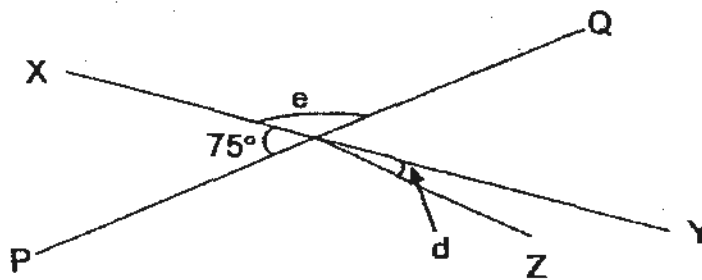

Ans: _____°

- 5 Draw and label a parallelogram KLMN with $\angle KLM = 80^\circ$ and $KN = 6\text{ cm}$. The line KL has been drawn for you.



For questions 6 to 18, show your working clearly in the space provided for each question and write your answers in the spaces provided. The number of marks available is shown in brackets [] at the end of each question or part-question.

(50 marks)

-
- 6 The total length of two poles is 5.1 m. 30% of the length of the shorter pole and 50% of the length of the longer pole add up to 2.25 m. Find the length of the shorter pole in **centimetres**.

Ans: _____ [3]

-
- 7 Zafira spent $\frac{1}{4}$ of her money and an additional \$24 on a present for her husband. She spent $\frac{1}{3}$ of the remaining money and an additional \$10 on some cosmetics for herself. If she had \$14 left, how much money did she have at first?

Ans: _____ [3]

8 Study the figure below. DFH and EFG are straight lines.

(a) Find the value of $\angle s + \angle t + \angle u + \angle v$.

(b) Find $\angle w$.

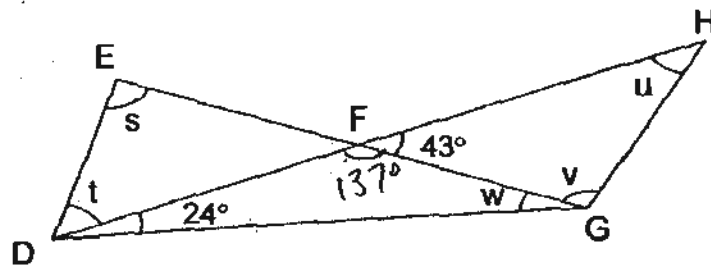

Ans: (a) _____ [1]

(b) _____ [2]

- 9 A water tank had a base measuring 50 cm by 20 cm. Water was pumped out from the tank using both Pump A and Pump B, starting at the same time. Pump A was pumping out water at a rate of 200 cm^3 per minute, while Pump B was pumping out water at a rate of 300 cm^3 per minute. If the initial water level in the tank was 30 cm, how much water was left in the tank after 5 minutes? Express your answer in litres.

Ans: _____ [3]

10 A class of pupils are taking bumboat rides to a nearby island. A fixed number of bumboats are hired. All bumboats are used and each bumboat is used for only one ride. If each bumboat ferries 10 pupils, the last bumboat will only ferry 4 pupils. If each bumboat ferries 8 pupils, 4 pupils cannot get onto any bumboats.

- (a) How many bumboats are hired?
- (b) How many pupils are there in the class?

Ans: (a) _____ [2]

(b) _____ [1]

- 11 In 2008, the enrolment of Jing Tao Primary School was 60% that of Shu Quan Primary School. In 2009, 120 pupils left Shu Quan Primary School. In the end, the enrolment of Jing Tao Primary School was 80% that of Shu Quan Primary School in 2009. What was the enrolment of Jing Tao Primary School in 2009?

Ans: _____ [4]

- 12 The figure below shows a rectangle HJLN where $HJ = 40$ cm and $JL = 30$ cm. The ratio of the lengths of $HG : LM : LN$ is $1 : 6 : 8$. Given that $JK = KL$ and $HP = PN$, find the total area of the shaded parts.

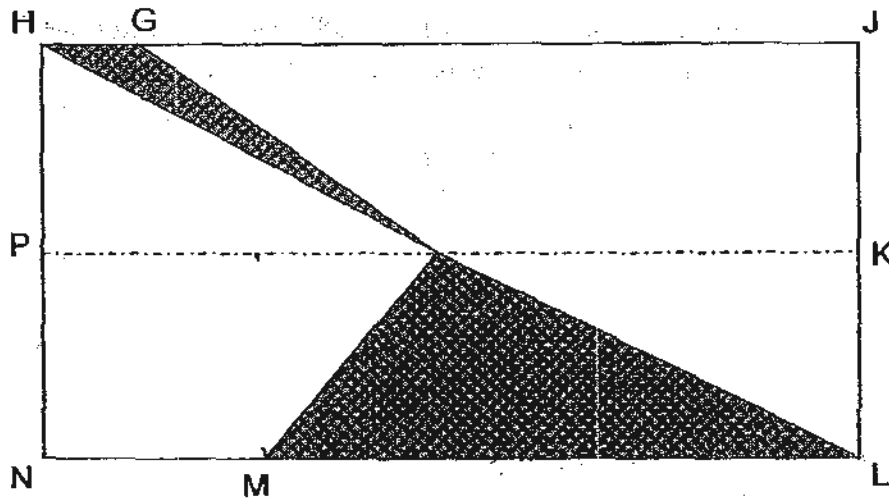

Ans: _____ [4]

13 Shop A and Shop B are selling ePad.

If Shop A sells the ePad at a discount of 10%, its discounted selling price will be \$300 more than the usual selling price in Shop B.

If Shop A sells the ePad at a discount of 50%, its discounted selling price will be \$100 less than the usual selling price in Shop B.

Find the usual selling price of the ePad in Shop B.

Ans: _____ [4]

14 Pupils in 5A completed an online assignment and scored an average of 56 marks. However, if 6 of them had scored 9 more marks each, the pupils' average score would be 57.5.

(a) How many pupils were there in 5A?

(b) If the 6 pupils scored 9 fewer marks each, what would be the new average score of 5A?

Ans: (a) _____ [2]

(b) _____ [2]

15 In the diagram below, ABCD is a rhombus. ABE and AGF are straight lines. If $AG = BC$, $\angle BAG = 24^\circ$ and $\angle BCE = 34^\circ$,

- (a) Find $\angle ABG$.
- (b) Find $\angle ACB$.
- (c) Find $\angle EFG$.

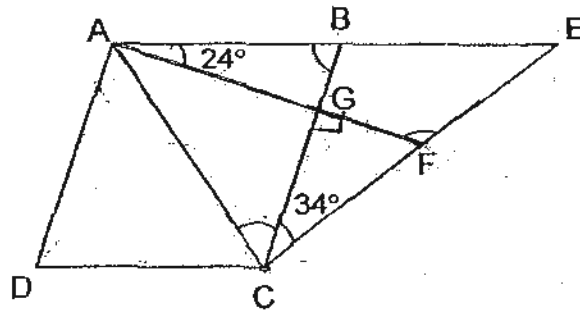

Ans: (a) _____ [1]

(b) _____ [1]

(c) _____ [2]

- 16 Yili, Lynn and Devi went shopping. Yili spent 0.25 of the total amount Lynn and Devi spent, while Devi spent $\frac{4}{11}$ of the total amount Yili and Lynn spent. Lynn spent \$37.50 more than Yili. If Lynn had \$90 before she went shopping, what fraction of her money did she spend? Express your answer in its simplest form.

Ans: _____ [5]

- 17 A coin box contained some twenty-cent and fifty-cent coins in the ratio of 4 : 5. When 16 fifty-cent coins were taken out and replaced by some twenty-cent coins, the ratio then became 8 : 7. The total value of the twenty-cent coins added was the same as the total value of the fifty-cent coins taken out. Find the sum of money in the coin box.

Ans: _____ [5]

- 18 A tank measuring 50 cm by 20 cm by 22 cm, with some cubes placed inside, was filled with 3.875 l of water to the height as shown in Diagram 1. Some water was then added into the tank to the height as shown in Diagram 2. The total amount of water in the tank was then 8.375 l. If another 3.9 l of water was added into the tank, what would be the final height of the water level in the tank?

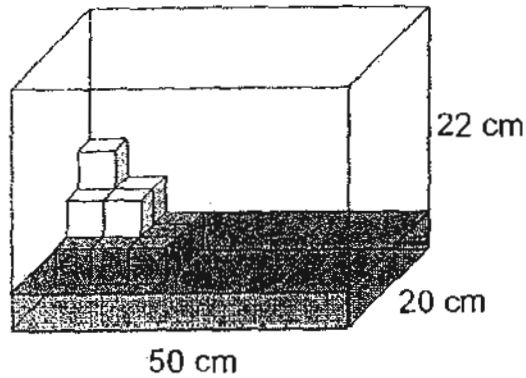

Diagram 1

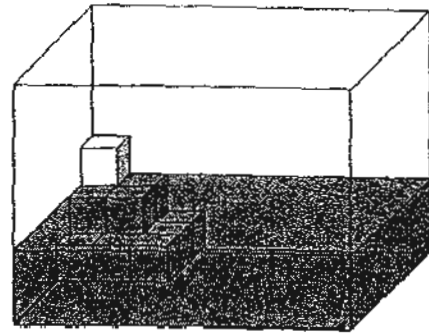

Diagram 2.

Ans: _____ [5]

END OF PAPER

Setters: Mrs Nancy Lum
Mdm Serene Leong

ANSWER SHEET

EXAM PAPER 2010

SCHOOL : NANYANG PRIMARY
 SUBJECT : PRIMARY 5 MATHEMATICS

TERM : SA2

Q1	Q2	Q3	Q4	Q5	Q6	Q7	Q8	Q9	Q10	Q11	Q12	Q13	Q14	Q15
2	2	1	1	3	3	3	2	2	4	4	2	3	4	4

- | | | | | |
|--------|----------|----------|---------|------------------------|
| 16)355 | 17)11/24 | 18)13:22 | 19)9.80 | 20)62.5% |
| 21)50° | 22)42° | 23)37° | 24)44 | 25)4500cm ³ |
| 26)168 | 27)1:6 | 28)53 | 29)9 | 30)33 |

Paper 2

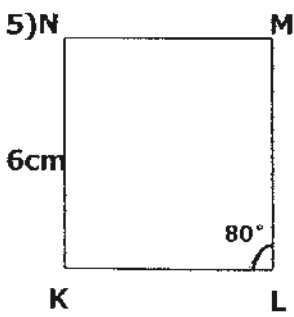
1)3 units→30 1 unit→10 (Son's reguled age) $10 - 5 = 5$ years' time	2) $35 \div 5 = 7$ $7 \times 6 = 42$
3) $6\frac{3}{5} - 2\frac{1}{2} = 4\frac{1}{10}$ $4\frac{1}{10} \div 2 = 2\frac{11}{20}$ $2\frac{1}{2} - 2\frac{11}{20} = 4\frac{19}{20}$ kg	4) $180^\circ - 75^\circ = 105^\circ$ $105^\circ \div 7 = 15^\circ$
5)N M  K L	6)30% S + 50% L→2.25 100% S + 100% L→5.1 60% S + 100% L→4.5 $40\% S \rightarrow 4.5 - 2.25 = 0.6$ $10\% S \rightarrow 0.6 \div 4 = 0.15$ $100\% S \rightarrow 0.15 \times 10 = 1.5$ 1.5m = 150cm
7) $\$14 + \$10 = \$24$ $\$24 \div 2 = \12 $\$12 \times 3 = \36 $\$36 + \$24 = \$60$ $\$60 \div 3 = \20 $\$20 \times 4 = \80	8)a) $180^\circ - 43^\circ = 137^\circ$ $137^\circ \times 2 = 274^\circ$ b) $180^\circ - 43^\circ = 137^\circ$ $180^\circ - 137^\circ - 24^\circ = 19^\circ$

<p>9) $200\text{cm}^3 \times 5 = 1000\text{cm}^3 = 1000\text{ml}$ $300\text{cm}^3 \times 5 = 1500\text{cm}^3 = 1500\text{ml}$ $(1000+1500)\text{ml} = 2500\text{ml}$ $50\text{cm} \times 20\text{cm} \times 30\text{cm} = 30000\text{cm}^3$ $= 30000\text{ml}$ $30000\text{ml} - 2500\text{ml} = 27500\text{ml}$ $= 27.5\text{ L}$</p>	<p>10)a) $44 \div 10 = 4\text{R } 4$ pupils $4 + 1 = 5$ bumboats. b) 44 pupils.</p>
<p>11) $60/100 = 3/5$ $80/100 = 4/5$ $15\text{units} \rightarrow 20\text{units} - 480$ $480 \rightarrow 20\text{units} - 15\text{units}$ $480 \rightarrow 5\text{units}$ $96\text{units} \rightarrow 1\text{ unit}$ $3\text{units} \rightarrow 96 \times 3 = 288$</p>	<p>12) $30 \times 15 \div 2 = 225$ $5 \times 15 \div = 37.5$ $225 + 37.5 = 262.5\text{cm}$</p>
<p>13) $9\text{units} - \\$300 \rightarrow \text{Shop B}$ $5\text{units} + \\$100 \rightarrow \text{Shop B}$ $9\text{units} - \\$300 \rightarrow 5\text{units} + \\100 $9\text{units} - 5\text{units} \rightarrow \\$100 + \\$300$ $4\text{units} \rightarrow \\400 $1\text{unit} \rightarrow \\100 $9\text{units} \rightarrow \\900 $\\$900 - \\$300 = \\$600$</p>	<p>14)a) $6 \times 9 = 54$ (extra) $57.5 - 56 = 1.5$ (extra in ave) $54 - 1.5 = 36$ b) $36 \times 56 = 2016$ $9 \times 6 = 54$ $2016 - 54 = 1962$ $1962 \div 36 = 54.5$</p>
<p>15)a) $(180^\circ - 24^\circ) \div 2 = 78^\circ$ b) $(180^\circ - 78^\circ) \div 2 = 51^\circ$ c) $51^\circ - 24^\circ = 27^\circ$ $51^\circ + 34^\circ = 85^\circ$ $85^\circ + 27^\circ = 112^\circ$</p>	<p>16) $Y + L \rightarrow 11\text{units}$ and $Y \rightarrow 3\text{units}$ $L \rightarrow 11\text{units} - 3\text{units} = 8\text{units}$ $D \rightarrow 12\text{units} - 8\text{units} = 4\text{units}$ $8\text{units} - 3\text{units} = 5\text{units}$ $5\text{units} \rightarrow \\37.50 $1\text{ unit} \rightarrow \\7.50 $8\text{units} \rightarrow \\60 $60/90 = 2/3$</p>
<p>17) $16 \times 50\text{c} = \\8 $\\$8 \div \\$0.20 = 40$ $20\text{c} : 50\text{c}$ $4 : 5$ $4\text{units} + 40 : 5\text{units} - 16$ $40\text{ units} - 128 \rightarrow 28\text{units} + 280$ $40\text{units} - 28\text{units} \rightarrow 280 + 128$ $12\text{units} \rightarrow 408$ $1\text{unit} \rightarrow 34$ $4\text{units} \rightarrow 136$ (number of 20c coins) $5\text{units} \rightarrow 170$ (number of 50c coins) $136 \times 20\text{c} = \\27.20 $170 \times 50\text{c} = \\85 $\\$27.20 + \\$85 = \\$112.20$</p>	<p>18) $8.375 - 3.875 = 4.5$ $4.5\text{L} = 4500\text{cm}^3$ Volume of (9-4)cubes $\rightarrow 4500\text{cm}^3 - 3875\text{cm}^3 = 625\text{cm}^3$ $5\text{ cubes} \rightarrow 625\text{cm}^3$ $1\text{ cube} \rightarrow 125\text{cm}^3$ Since $5\text{cm} \times 5\text{cm} \times 5\text{cm} = 125\text{cm}^3$ Length of 1 cube $\rightarrow 5\text{cm}$ Base area after layer 2 \rightarrow $(50\text{cm} \times 20\text{cm}) - (5\text{cm} \times 5\text{cm})$ $= 975\text{cm}^2$ Height of water level after layer \rightarrow $3900\text{cm}^3 \div 975\text{cm}^3 = 4\text{cm}$ Height of water level $\rightarrow 5\text{cm} + 5\text{cm} + 4\text{cm}$ $= 14\text{cm}$</p>