



**RAFFLES GIRLS' PRIMARY SCHOOL
SEMESTRAL ASSESSMENT 2
MATHEMATICS (PAPER 1)
PRIMARY 5**

Name: _____ ()

Form Class: P5 _____ Banded Math Class: P5 _____

Date: 27 October 2010

Duration: 50 min

Your Score (Out of 100 marks)			
Your Score (Out of 40 marks)			
		Banded Math Class	Level
PAPER 1 (40%)	Highest Score		
	Average Score		
TOTAL (100%)	Highest		
	Average Score		
Parent's Signature			

INSTRUCTIONS TO CANDIDATES

1. Do not turn over this page until you are told to do so.
2. Follow all instructions carefully.
3. Answer **ALL** questions and show all working clearly.
4. **NO** calculator is allowed for this paper.

SECTION A (20 marks)

Questions 1 to 10 carry 1 mark each. Question 11 to 15 carry 2 marks each. For each question, four options are given. One of them is the correct answer. Make your choice (1, 2, 3 or 4). Shade your answer (1, 2, 3 or 4) on the OAS provided. All diagrams are not drawn to scale.

1. Which of the following is the best estimate for 42.56×6.45 ?

(1) 42×6

(2) 42×7

(3) 43×6

(4) 43×7

()

2.

$$4 \frac{2}{3} = 3 \frac{\square}{3}$$

What is the missing number in the \square above?

(1) 5

(2) 2

(3) 3

(4) 4

()

3. Find the area of the shaded figure.

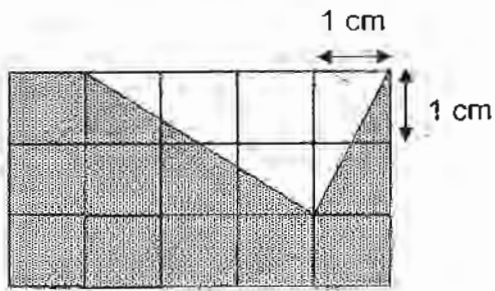

(1) 4 cm^2

(2) 5 cm^2

(3) 11 cm^2

(4) 14 cm^2

()

4. After turning clockwise 135° , Jennifer is facing the grocery store now. Which direction was she facing at first ?

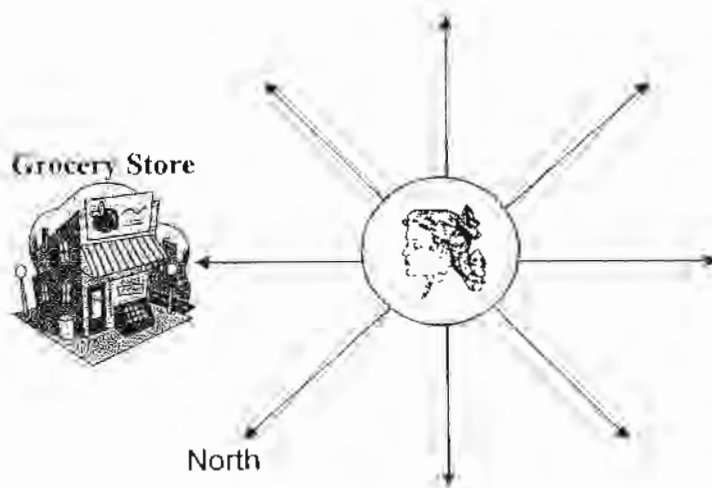

(1) South

(2) West

(3) South-West

(4) North-East

()

5. What is the unit shape used in the tessellation below?

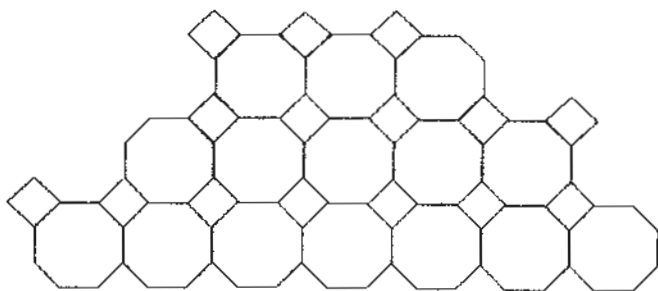

(1)



(2)

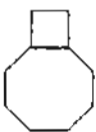

(3)



(4)

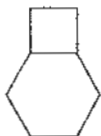

()

6. 330 pupils went on an excursion. Each teacher can look after a maximum of 20 pupils. What is the least number of teachers required for the excursion?

(1) 16

(2) 16.5

(3) 17

(4) 17.5

()

7. Sally bought a book for \$24 at a 25% discount. What was the usual price of the book?

(1) \$6

(2) \$18

(3) \$32

(4) \$49

()

8. Express $7\frac{19}{25}$ as a decimal.

(1) 7.076

(2) 7.706

(3) 7.76

(4) 7.95

()

9. A piece of paper strip was coloured into 3 sections: Yellow (Y), Blue (B) and Red (R) as shown below.

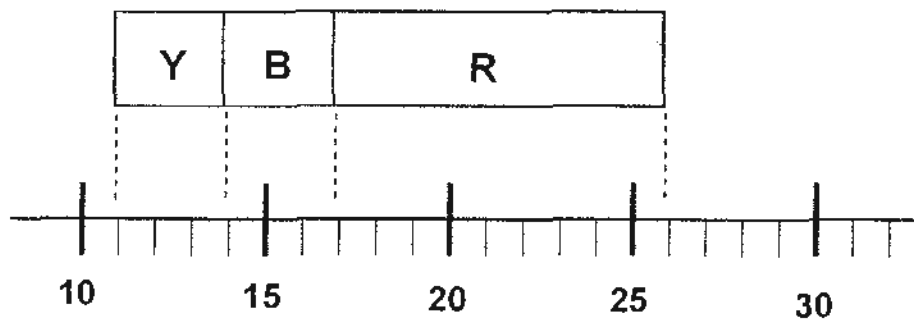

What is the ratio of the length of the yellow section to the length of the blue section to the length of the red section?

(1) 1 : 1 : 3

(2) 2 : 2 : 5

(3) 3 : 1 : 1

(4) 5 : 2 : 2

()

10. Mrs Tan bought a bag of potatoes daily for 1 week.
The average cost of each bag of potatoes was \$2.50.
What was the total amount she paid for the potatoes in that week?

(1) \$2.50

(2) \$10.00

(3) \$17.50

(4) \$25.00

()

11. Which of the following figure has no line(s) of symmetry?

(1)



(2)

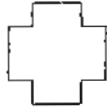

(3)

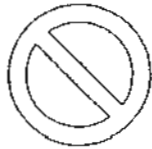

(4)

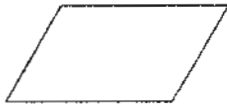

()

12. Mrs Huang needs $1\frac{2}{3}$ m of cloth to make a dress.

How much cloth does she need to make 8 such dresses?

(1) 13 m

(2) $13\frac{1}{3}$ m

(3) $13\frac{2}{3}$ m

(4) 14 m

()

13. A piece of square paper was cut along the dotted line as shown in Figure A to get four smaller pieces (W, X, Y, Z) of paper as shown in Figure B.

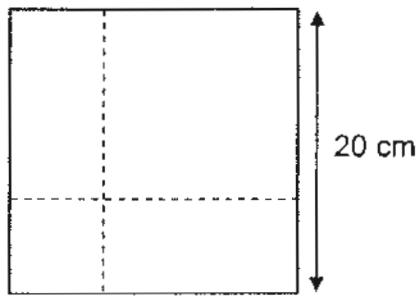

Figure A

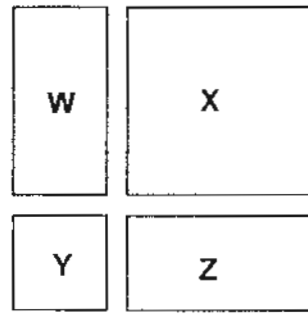

Figure B

Find the total perimeter of rectangle W, X, Y and Z.

- (1) 80 cm
- (2) 120 cm
- (3) 160 cm
- (4) 200 cm

()

14. What is the missing number in the box below?

$$\square : 16 = 35 : 40$$

- (1) 7
- (2) 8
- (3) 11
- (4) 14

()

SECTION B (20 marks)

Questions 16 to 25 carry 1 mark each. Write your answers in the spaces provided. For questions which require units, give your answers in the units stated. All diagrams are not drawn to scale unless otherwise stated. Answers in fractions or ratio must be expressed in the simplest form.

16. Arrange the following in descending order.

$$0.805, \quad \frac{1}{4}, \quad 0.128, \quad \frac{4}{5}$$

Ans: _____

17. Find the value of $27 \times (8.37 + 1.63)$.

Ans: _____

18. Before Grace started cooking dinner, she had $1\frac{1}{8}\ell$ of oil.

After she had finished cooking, she had $\frac{3}{4}\ell$ of oil left.

How many litres of oil did Grace use for cooking?

Ans: _____ ℓ

19. Triangle XYZ is an isosceles triangle.
Find $\angle XZY$.

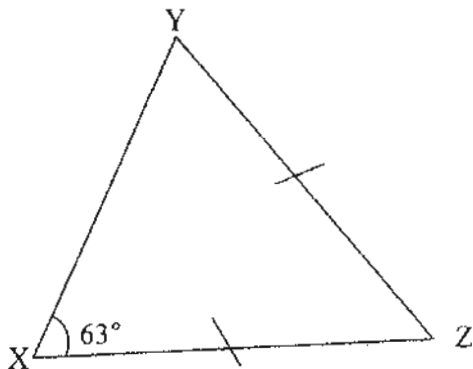

Ans: _____^o

20. The graph below shows how Miss Lim allocated her monthly income.

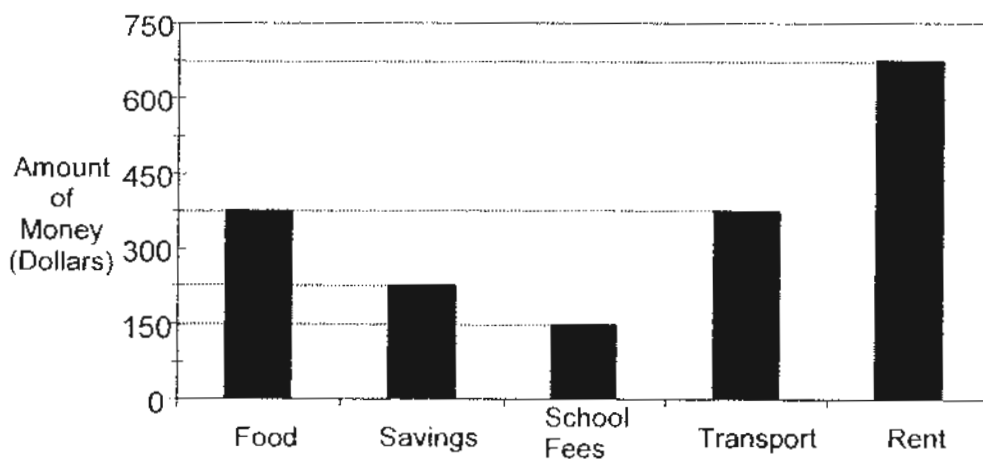

Distribution of Miss Lim's Monthly Income

What was her total spending monthly?

Ans : \$ _____

21. Express 0.028 as a fraction.

Ans: _____

22. A book is sold at \$50 without 7% G.S.T.
How much is the G.S.T of this book?

Ans: \$ _____

23. The figure below shows three boxes, P, Q and R on a balance scale.
Given that the average mass of Boxes P and Q is 15 kg, find the average mass of the 3 boxes.

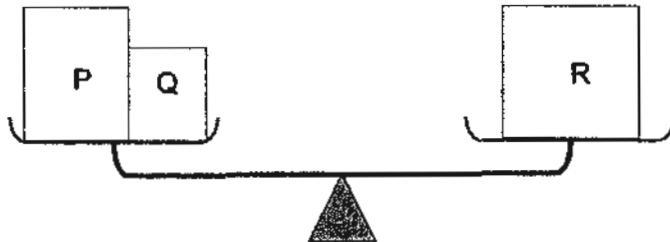

Ans: _____ kg

24. The pattern in the box shows a tessellation using a unit shape. Extend the tessellation by drawing **two more** unit shapes in the space provided in the box.

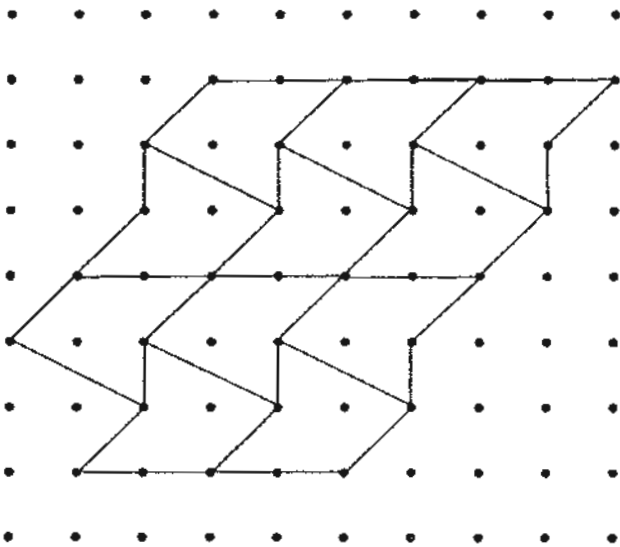

25. What percentage of the figure shown below is shaded?

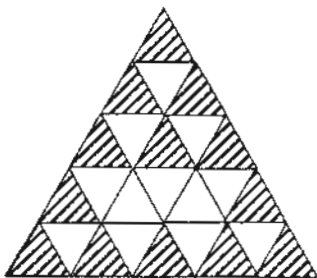

Ans: _____ %

Questions 26 to 30 carry 2 marks each. Show your working clearly in the space provided for each question and write your answers in the space provided. For questions which require units, give your answers in the units stated. All diagrams are not drawn to scale unless otherwise stated. Answers in fractions or ratio must be expressed in the simplest form.

26. The figure below shows a container of water

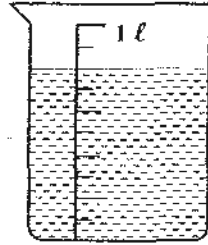

(a) What is the amount of water in it?

(b) Susan pours all the water from the container above equally into 5 glasses. What is the amount of water in each glass?

Ans: (a) _____ ml

(b) _____ ml

27 Mr Beesi has $\frac{11}{12}$ h to play with his two children. If he wants to spend an equal amount of time alone with each child, how much time does he spend with each of them?

Ans: _____ h

- 28 The figure below showed a rectangle PQRS.
 PYR is a straight line, and XYZ is parallel to STR.
 PX = 10 cm, TR = 9 cm and ZR = 4 cm.
 Find the shaded area of rectangle XYTS.

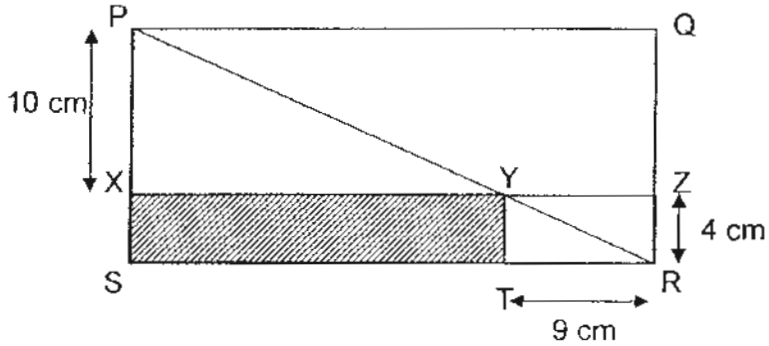

Ans: _____ cm²

29. The diagram below shows a shaded triangle ABC within the square grids.
 Using BC as the base, draw another triangle within the grid that has the **same**
 area as triangle ABC and has one angle that is **larger** than 90°.

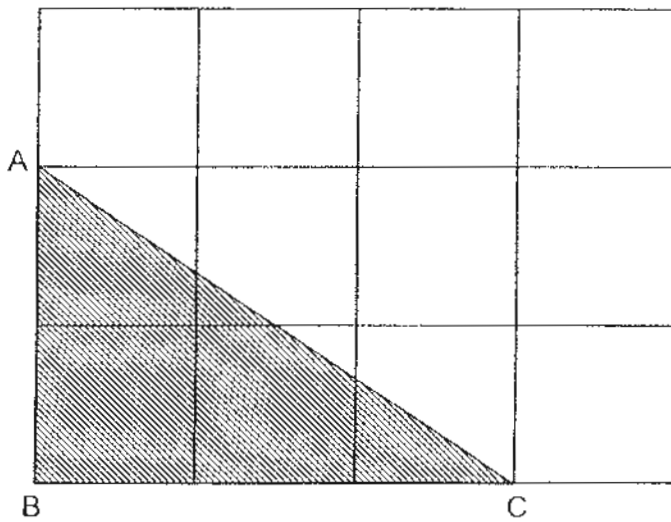

30. The height of Plant X was measured on every first day of the month for 5 months.
The line graph below shows the growth of Plant X in terms of its height.

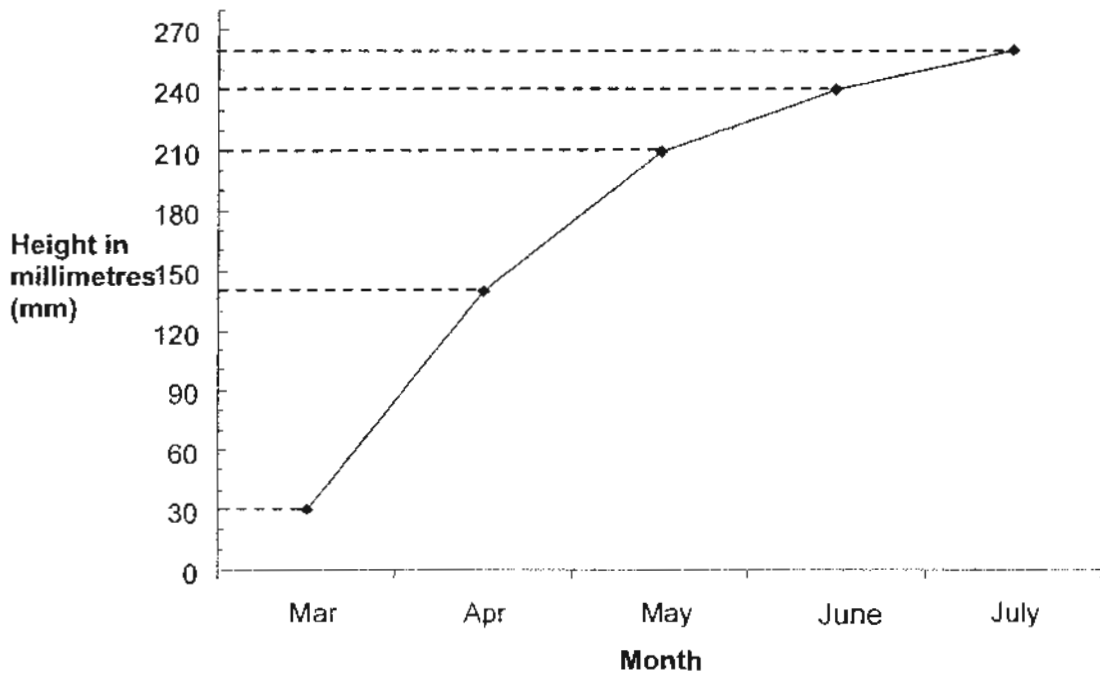

- (a) Which one-month period was the growth of Plant X the **greatest**?
- (b) From 1st April to 1st June, what was the average growth in millimetres per day? Express your answer as a fraction. (Assume each month has 30 days)

Ans: (a) From 1st _____ to 1st _____

(b) _____ mm

End of Paper-
 ☺ Please check your work carefully ☺

Setters: Mr Desmond Lee
 Mr Ronald Lee
 Mrs Jenine Soh



**RAFFLES GIRLS' PRIMARY SCHOOL
SEMESTRAL ASSESSMENT 2
MATHEMATICS (PAPER 2)
PRIMARY 5**

Name: _____ ()

Form class: P5 _____ Banded Math Class: P5 _____

Date: 27 October 2010

Duration: 1 h 40 min

Your Score (Out of 60 marks)		
	Banded Math Class	Level
Highest Score		
Average Score		

INSTRUCTIONS TO CANDIDATES

5. Do not turn over this page until you are told to do so.
6. Follow all instructions carefully.
7. Answer **ALL** questions and show all working clearly.
8. The use of calculator is allowed for this paper.

Questions 1 to 5 carry 2 marks each. Show your working clearly in the space provided for each question and write your answers in the spaces provided. For questions which require units, give your answers in the units stated. All diagrams are not drawn to scale unless otherwise stated. (10 marks)

1. In the diagram below, PQRS is a parallelogram. QRAB is a square. SBR is a straight line. Find $\angle PSR$.

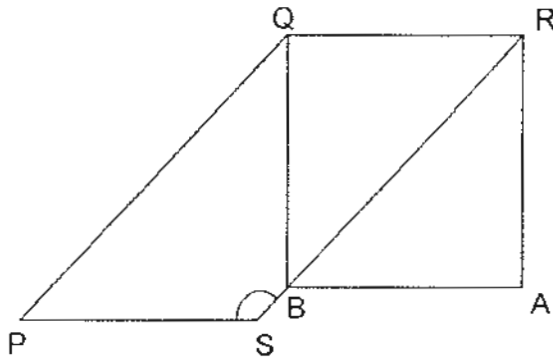

Ans: _____° [2]

2. 2 groups of tourists visited a museum.
One group with eight children and four adults paid \$160.
The other group with two children and four adults paid \$100.
What is the cost of entry for a child?

Ans: \$ _____ [2]

3. Line DE and EF are 2 sides of a rhombus.

(a) Measure and write down the size of $\angle DEF$.

(b) Complete the figure by drawing the other 2 sides of the rhombus. [1]

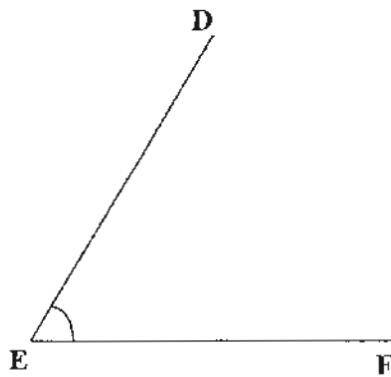

Ans: (a) _____ ° [1]

4. The figure below is made up of some 1-cm cubes.

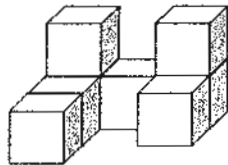

What is the **minimum** number of 1-cm cubes that need to be added to the figure above to form a bigger cube?

Ans: _____ [2]

5. The figure ABCDEFG below is made up of 3 squares of sides, 4cm, 8cm and 8cm respectively. Find the shaded area GDF.

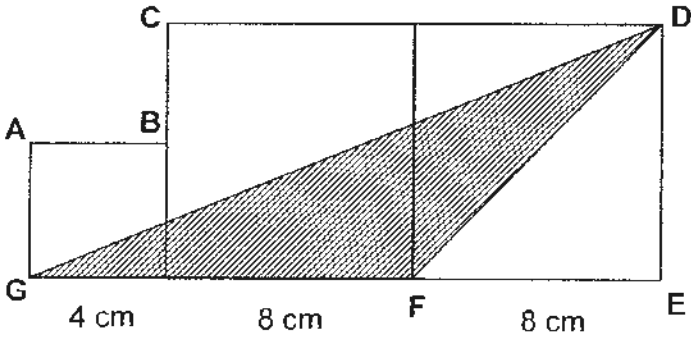

Ans: _____ [2]

For questions 6 to 18, show your working clearly in the space provided for each question and write your answers in the spaces provided. All diagrams are not drawn to scale unless otherwise stated.

The number of marks available is shown in the brackets [] at the end of each question or part-question. (50 marks)

6. Brenda used a piece of wire to form the figure below and was left with 46 cm after that.

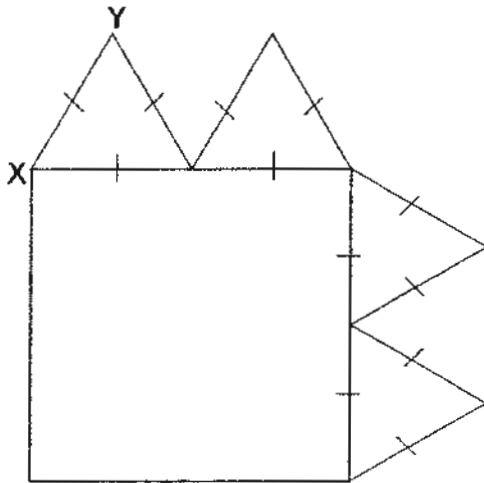

- (a) Given that the piece of wire was 3.1m long, how much wire had Brenda used to form the figure above?
- (b) Find the length of line XY.

Ans: (a) _____ [1]

(b) _____ [2]

7. In the diagram below, ABCD and CEFG are trapeziums, and ADH is an equilateral triangle.
 $\angle CEF$ is 129° , $\angle ABC$ is 148° , $\angle EFG$ is 41° and DHCG is a straight line.
 Find $\angle BCE$.

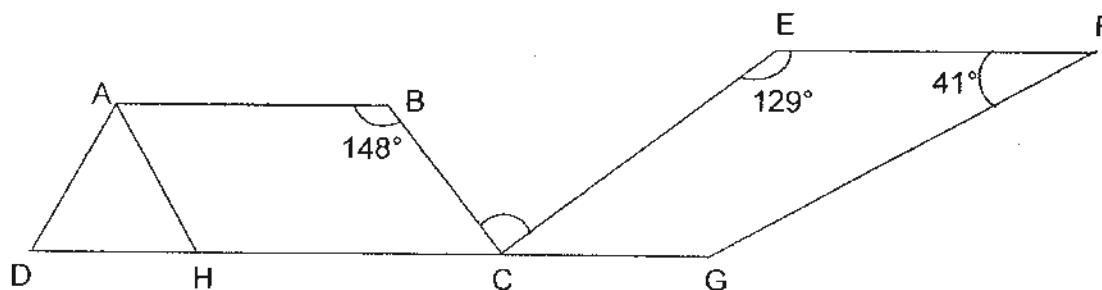

Ans: _____ [3]

8. The average height of 5 girls is 165 cm.
 The average height of 5 boys is 170 cm.
 What is the average height of these 10 children?

Ans: _____ [3]

9. In the Art Club last year, 40% of the members were boys. After 45 girls left the Art Club this year, the ratio of the number of boys to the number of girls in the club became 4 : 3.
- (a) How many members were in the Art Club last year?
- (b) How many more girls must join the club this year so that there is an equal number of boys and girls in the Art Club this year?

Ans: (a) _____ [3]

Ans: (b) _____ [1]

10. Andy wanted to set-up an aquarium with an empty rectangular glass tank that his father had bought him. The base area of the tank was 3600 cm^2 . Andy was able to fill the tank with 3ℓ of water every one minute.
- (a) How long would it take the water to reach a depth of 10 cm?
- (b) If it took 60 minutes to fill the whole tank, find the height of the tank.

Ans: (a) _____ [2]

(b) _____ [1]

11. Study the conversation below between Mr Lim and the salesman at the toy section of the department store.

Mr Lim : How much do 7 toy boats and 6 toy planes cost?

Salesman : They cost a total of \$52.50.

Mr Lim : That is above my budget.
How about 6 toy planes and 5 toy trains?

Salesman : They are cheaper. They cost only \$43.50

If a toy train costs as much as a toy boat, how much does a toy plane cost?

Ans: _____[3]

12. Mr Chua gave $\frac{7}{13}$ of his salary to his parents and used $\frac{1}{4}$ of the remaining amount to pay his handphone bill. Then he spent $\frac{2}{3}$ of the money he had left on food and saved the rest.

(a) How much did Mr Chua spent on his handphone bill and food if he saved \$319.50.

(b) How much was Mr Chua's salary?

Ans: (a) _____ [2]

(b) _____ [2]

13. The angles inside a figure are called interior angles. Below are four figures with their interior angles marked.

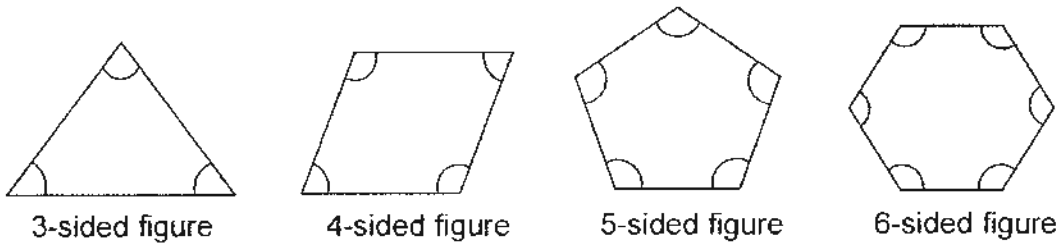

- a) Observe the pattern in the table below.
 What is the sum of interior angles for a 7-sided figure and 8-sided figure respectively? Write your answers in the table below.

Total number of sides of the figure	Sum of interior angles
3	180°
4	360°
5	540°
6	720°
7	(i) [1]
8	(ii) [1]

- b) What is the sum of interior angles for a 59-sided figure?

Ans: (b) _____ [2]

14. A florist sold twice as many roses as tulips and collected \$400 in total. She collected \$80 more on the tulips than the roses. Given that a tulip costs \$2 more than a rose, find the cost of a rose.

Ans: _____[4]

15. George had to deliver 70 gift packs.
He was paid \$1.60 for every gift pack delivered and was charged \$8.65 for
damaging one.
After delivering all the gift packs, he was paid \$50.50.
How many gift packs did he damage?

Ans: _____ [4]

16. Mr Lim wants to buy some boxes of chocolates which are sold in boxes of 10 and 24. Each box of 10 pieces is sold for \$5.35 and each box of 24 pieces is sold for \$12.50.

Mr Lim and his class of 37 pupils will be given 2 pieces of chocolates each.

(a) How many boxes of each type of chocolates should Mr Lim buy so that the number of pieces of chocolates left over is the least?

(b) How much will Mr Lim pay for the chocolates?

Ans: (a) _____ box(es) of 10 and _____ box(es) of 24 [4]

(b) _____ [1]

17. Boon Keng had two wooden planks of the same length. He cut one wooden plank into equal parts of length 80 cm and each part he pasted 4 circular stickers as in Figure A.

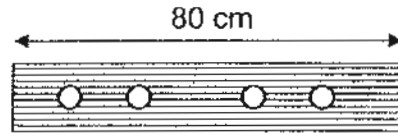

Figure A

After that, he cut the other wooden plank into equal parts of length 1.4 m and each part he pasted 9 triangular stickers as in Figure B.

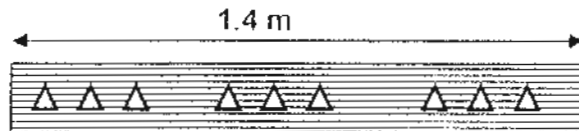

Figure B

When he finished pasting, he counted that there were 136 more triangular stickers than circular stickers.

- (a) Express the length of the wooden plank in Figure B in cm.
(b) How many stickers did Boon Keng paste altogether?

Ans: (a) _____ [1]

(b) _____ [4]

18. At an international school, 40% of the students are Asians, 90% of the remainder are Europeans and the rest are Americans.
There are 56 more Europeans than Asians.
After some Asians left the school, 20% of the remaining students are Asians.
How many Asians are there left at the international school?

Ans: _____[5]

-End of Paper-
Please check your work carefully 😊

Setters: Mr Desmond Lee
Mr Ronald Lee
Mrs Jenine Soh

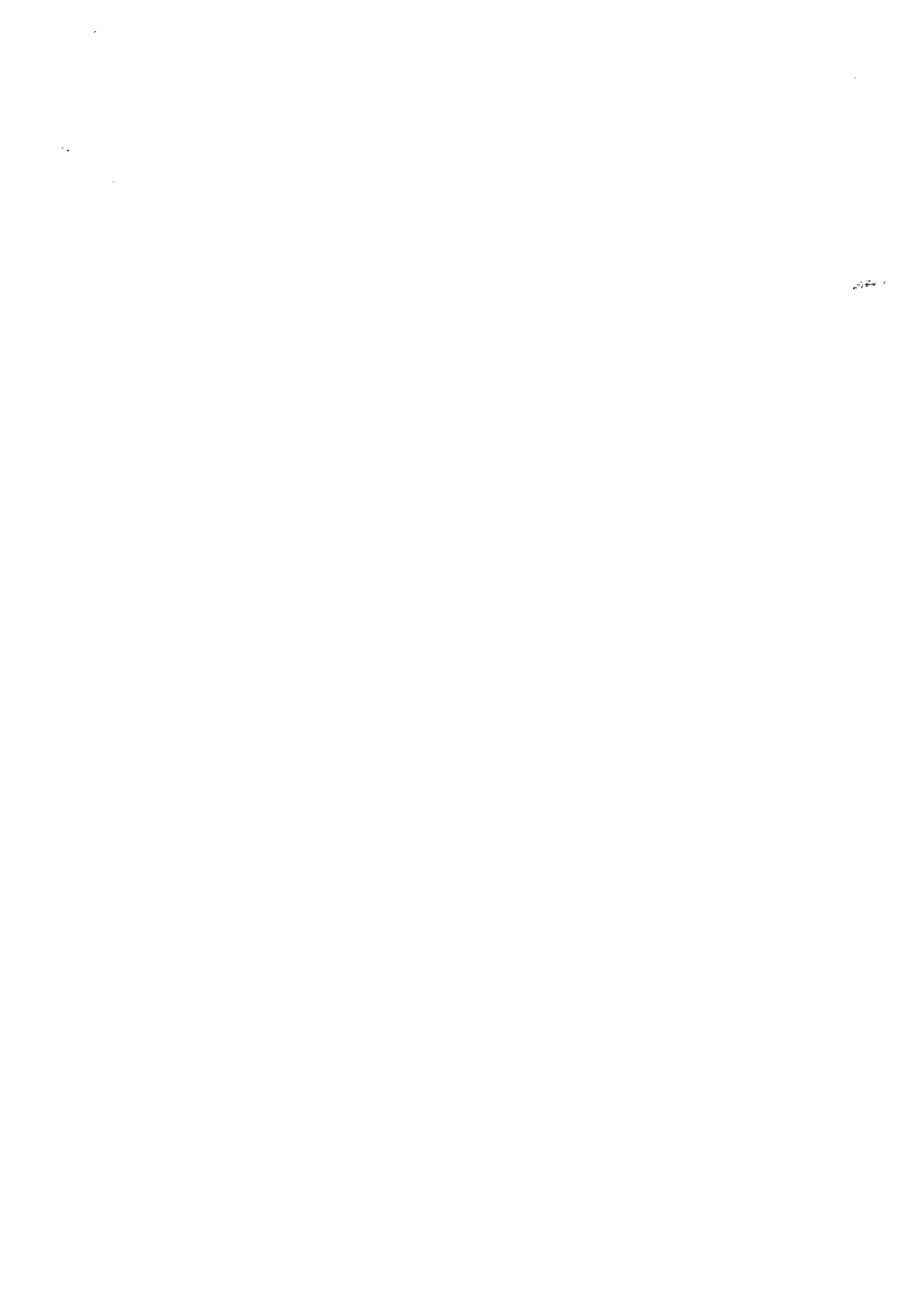

ANSWER SHEET

EXAM PAPER 2010

SCHOOL : RAFFLES GIRLS' PRIMARY
 SUBJECT : PRIMARY 5 MATHEMATICS

TERM : SA2

Q1	Q2	Q3	Q4	Q5	Q6	Q7	Q8	Q9	Q10	Q11	Q12	Q13	Q14	Q15
3	1	3	2	2	3	3	3	1	3	4	2	3	4	2

Q16 - Ans: 0.805, $\frac{4}{5}$, $\frac{1}{4}$, 0.128

Q17 - Ans: 270

Q18 - Ans: $\frac{3}{8} \text{ L}$

Q19 - Ans: 54°

Q20 - Ans: \$1575

Q21 - Ans: $\frac{7}{250}$

Q22 - Ans: \$3.50

Q23 - Ans: 20 kg

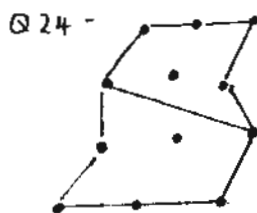

Q25) 52%

Q26) a) 800ML
 b) 160 ML

Q27) $\frac{11}{24}$ hour

28) 90 cm^2

29)

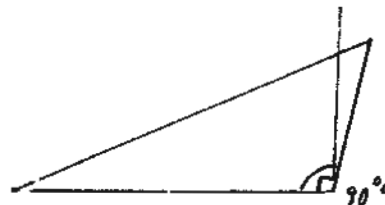

30) Ans: From 1st Mar to 1st Apr
 (a)

(b) $1\frac{2}{3}$ mm

For Question 1 to 5:

Correct Method and Correct Answer	2 marks
Correct Answer with no working	2 marks
Correct Method but Wrong Answer	Award M1 accordingly
Correct Answer but Wrong Method	0 mark

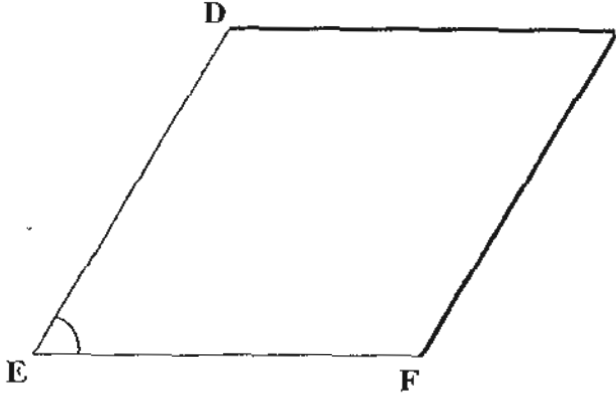
1.	$90^\circ \div 2 = 45^\circ$ $180^\circ - 45^\circ = \underline{135^\circ}$	--- M1, A1
2.	$8C + 4A \rightarrow 160$ $2C + 4A \rightarrow 100$ $6C \rightarrow \$60$ $1C \rightarrow \$60 \div 6$	$= \underline{\$10}$ [M1, A1]
3.	(a) $60^\circ \pm 1^\circ$ (b) 	
4.	$27 - 8 = 19$ [M1, A1]	
5.	shaded area $\rightarrow (12 \times 8) \div 2 = 48 \text{ cm}^2$ [M1, A1]	

RGPS 2010 P5 Mathematics SA2 (Paper 2)

For Question 1 to 5:

Correct Method and Correct Answer	2 marks
Correct Answer with no working	2 marks
Correct Method but Wrong Answer	Award M1 accordingly
Correct Answer but Wrong Method	0 mark

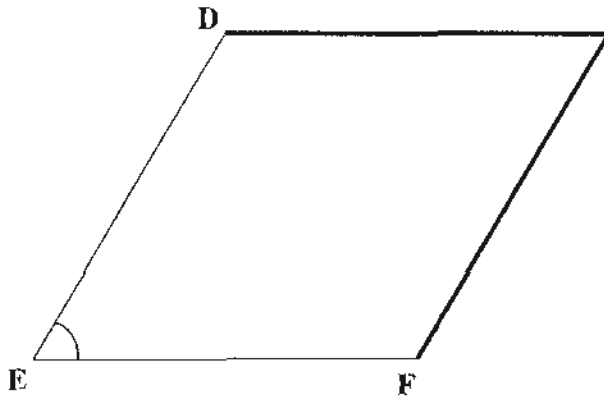
1.	$90^\circ \div 2 = 45^\circ$ $180^\circ - 45^\circ = \underline{135^\circ}$	--- M1, A1
2.	$8C + 4A \rightarrow 160$ $2C + 4A \rightarrow 100$ $6C \rightarrow \$60$ $1C \rightarrow \$60 \div 6$	$= \underline{\$10}$ [M1, A1]
3.	(a) $60^\circ \pm 1^\circ$ (b) 	
4.	$27 - 8 = \underline{19}$ [M1, A1]	
5.	shaded area $\rightarrow (12 \times 8) \div 2 = \underline{48 \text{ cm}^2}$ [M1, A1]	

For Question 6 to 18

Marking Scheme

For all questions:

- Award A1 for correct answer with no method shown.
- Award A mark for clear transfer error to answer space by pupil. Indicate on the answer script “transfer error”.
- Award M mark(s) according for correct method or followed-through computation error with wrong answer. Indicate the M mark(s) on the answer script accordingly.
- No marks will be awarded for correct answer with wrong method. Indicate on the answer script “wrong method”.
- Deduct 1 mark from the total M mark(s) awarded if there is a *misread per question. No A mark will be awarded for this case. (*misread: clear numerical transfer error from the question to the working statement)
- Deduct a maximum $\frac{1}{2}$ mark per question for incorrect or missing required unit in final answer.
- Deduct a maximum of $\frac{1}{2}$ mark per question for incorrect use of mathematical signs such as = or \approx .

For 4-mark and 5-mark questions:

- Deduct a maximum of $\frac{1}{2}$ mark per question if there is an incorrect mathematical statement at the “M mark(s) awarded” step

6. (a) 264 cm or any equivalent [A1]
 (b) $264 \div 16 = 16.5$ cm or any equivalent [M1, A1]

7. $\left. \begin{array}{l} \angle BCD = 180^\circ - 148^\circ = 32^\circ \\ \angle ECG = 180^\circ - 129^\circ = 51^\circ \end{array} \right\} \text{M1}$
 $\angle BCE = 180^\circ - 51^\circ - 32^\circ = \underline{97^\circ}$ M1, A1
- OR
- $\angle BCD = 180^\circ - 148^\circ = 32^\circ$
 $\angle BCE = 129^\circ - 32^\circ = \underline{97^\circ}$ M2, A1 (Alternate angles)
- OR
- $\angle ECG = 180^\circ - 129^\circ = 51^\circ$
 $\angle BCE = 148^\circ - 51^\circ = \underline{97^\circ}$ M2, A1 (Alternate angles)

8.	$165 \times 5 = 825$ $170 \times 5 = 850$ $5 + 5 = 10$ $825 + 850 = 1675$ [M1] $1675 \div 10 = \underline{167.5 \text{ cm}}$ [M1, A1]
9.	<p>(a)</p> <p>Last year: This year: (45 girls left)</p> <p>B: G B:G</p> <p>2 : 3 4 : 3</p> <p>4 : 6</p> <p>3 units \rightarrow 45 1 unit $\rightarrow 45 \div 3 = 15$ [M1] 10 units $\rightarrow 15 \times 10 = \underline{150}$ [M1,A1]</p> <p>(b) 15 (1 unit) [A1]</p>

10.	<p>(a) $3600 \text{ cm}^2 \times 10 \text{ cm} = 36000 \text{ cm}^3$ time taken to reach 10 cm $\rightarrow 36000 \text{ cm}^3 \div 3000 \text{ ml} = \underline{12 \text{ minutes}}$ [M1,A1]</p> <p>(b) 60 minutes $\rightarrow 10 \text{ cm} \times 5 = \underline{50 \text{ cm}}$ [A1]</p>																
11.	$7B + 6P = 52.50$ $6P + 5T = 43.50$ Since cost of 1T = cost of 1B, $7u - 5u = 2u$ $2u \rightarrow 52.50 - 43.50 = 9$ (price of 2 toy boats) $1u \rightarrow 4.50$ [M1]																
	<table style="width: 100%; border: none;"> <tr> <td style="width: 33%;">$4.50 \times 5 = 22.50$</td> <td style="width: 33%; text-align: center;">OR</td> <td style="width: 33%;">$4.50 \times 7 = 31.50$</td> <td></td> </tr> <tr> <td>$43.50 - 22.50 = 21$</td> <td style="text-align: center;">OR</td> <td>$52.50 - 31.50 = 21$</td> <td style="text-align: right;">----- M1</td> </tr> <tr> <td style="padding-left: 20px;">$6u \rightarrow \\$ 21$</td> <td></td> <td></td> <td></td> </tr> <tr> <td style="padding-left: 20px;">$1u \rightarrow \underline{\\$ 3.50}$</td> <td></td> <td></td> <td style="text-align: right;">----- A1</td> </tr> </table>	$4.50 \times 5 = 22.50$	OR	$4.50 \times 7 = 31.50$		$43.50 - 22.50 = 21$	OR	$52.50 - 31.50 = 21$	----- M1	$6u \rightarrow \$ 21$				$1u \rightarrow \underline{\$ 3.50}$			----- A1
$4.50 \times 5 = 22.50$	OR	$4.50 \times 7 = 31.50$															
$43.50 - 22.50 = 21$	OR	$52.50 - 31.50 = 21$	----- M1														
$6u \rightarrow \$ 21$																	
$1u \rightarrow \underline{\$ 3.50}$			----- A1														

12.	<p>(a)</p> <p>1 unit of the remainder → \$319.50 3 units of the remainder → \$319.50 × 3 = \$958.50 [M1, A1]</p> <p>(b)</p> <p>$\frac{6}{13}$ of the total → \$1278 (319.50 + 958.50)</p> <p>$\frac{1}{13}$ of the total → \$1278 ÷ 6 = \$213 [M1]</p> <p>$\frac{13}{13}$ of the total → \$213 × 13 = \$2769 [A1]</p>
-----	--

13.	<p>(a) i) 900° [A1], ii) 1080° [A1]</p> <p>(b) 57 × 180° = 10 260° [M1, A1]</p>
-----	--

14.	<p>Roses → (\$400 - \$80) ÷ 2 = \$160 Tulips → \$400 - \$160 = \$240 [M1]</p> <p>2 units of roses = \$160 1 unit of tulips = \$240</p> <p>Difference between 1 unit of roses and 1 unit of tulips = \$240 - \$80 = \$160 [M1]</p> <p>No. of flowers in 1 unit = \$160 ÷ \$2 = 80 [M1]</p> <p>Cost of 1 rose = \$80 ÷ 80 = \$1 [A1]</p>
-----	--

15.	$1.60 \times 70 = 112$ $112 - 50.50 = 61.50$ $1.60 + 8.65 = 10.25$ $61.50 \div 10.25 = \underline{6 \text{ gift packs}}$	<p>----- M1</p> <p>----- M1</p> <p>----- M1, A1</p>
-----	---	---

16.	<p>(a) $37 + 1 = 38$ $38 \times 2 = 76$</p> <p style="text-align: right;">----- M1</p> <p><u>Make a list / Guess and Check method</u></p> <table border="1" style="width: 100%; border-collapse: collapse; text-align: center;"> <thead> <tr> <th style="width: 25%;">Boxes of 10</th> <th style="width: 25%;">Boxes of 24</th> <th style="width: 25%;">Total</th> <th style="width: 25%;">Chocolates left over</th> </tr> </thead> <tbody> <tr> <td>$0 \times 10 = 0$</td> <td>$3 \times 24 = 72$</td> <td>72</td> <td>Short of 4</td> </tr> <tr> <td>$1 \times 10 = 10$</td> <td>$3 \times 24 = 72$</td> <td>82</td> <td>6</td> </tr> <tr> <td>$2 \times 10 = 20$</td> <td>$2 \times 24 = 48$</td> <td>68</td> <td>Short of 8</td> </tr> <tr> <td>$3 \times 10 = 30$</td> <td>$2 \times 24 = 48$</td> <td>78</td> <td>2</td> </tr> <tr> <td>$5 \times 10 = 50$</td> <td>$1 \times 24 = 24$</td> <td>74</td> <td>Short of 2</td> </tr> </tbody> </table> <p>Award M1 for logical use of the table and another M1 for correct step to the final answer</p> <p>Thus, <u>3</u> boxes of 10 and <u>2</u> boxes of 24 ----- A1</p> <p>(b) $3 \times \\$5.35 + 2 \times \\$12.50 = \\$16.05 + \\$25 = \underline{\\$41.05}$ ----- A1</p>	Boxes of 10	Boxes of 24	Total	Chocolates left over	$0 \times 10 = 0$	$3 \times 24 = 72$	72	Short of 4	$1 \times 10 = 10$	$3 \times 24 = 72$	82	6	$2 \times 10 = 20$	$2 \times 24 = 48$	68	Short of 8	$3 \times 10 = 30$	$2 \times 24 = 48$	78	2	$5 \times 10 = 50$	$1 \times 24 = 24$	74	Short of 2
Boxes of 10	Boxes of 24	Total	Chocolates left over																						
$0 \times 10 = 0$	$3 \times 24 = 72$	72	Short of 4																						
$1 \times 10 = 10$	$3 \times 24 = 72$	82	6																						
$2 \times 10 = 20$	$2 \times 24 = 48$	68	Short of 8																						
$3 \times 10 = 30$	$2 \times 24 = 48$	78	2																						
$5 \times 10 = 50$	$1 \times 24 = 24$	74	Short of 2																						

17.

(a) **140 cm** [A1]

(b)

Compared length:

80 : 140

4 : 7

Equalised...

4 : 7

(x7) (x4)

Compared number of holes:

Circular : Triangular

4 : 9

(x7) (x4)

28 : 36 [M1]

$36 - 28 = 8$

8 units \rightarrow 136

1 unit \rightarrow $136 \div 8$ [M1]

$= 17$

64 units \rightarrow $17 \times 64 = 1088$ [M1, A1]

18. Asians – 40%
Europeans $\frac{90}{100} \times 60\% = 54\%$ [M1]

Diff betw Asians and Europeans

$$54\% - 40\% = 14\%$$

14% → 56 Europeans

$$1\% \rightarrow 56 \div 14 = 4$$

Total no. of students → $4 \times 100 = 400$ [M1]

No. of Europeans and Americans

$$\frac{60}{100} \times 400 = 240$$
 [M1]

After some Asians left, 80% are
Europeans and Americans

$$80\% \rightarrow 240$$

$$10\% \rightarrow 240 \div 8 = 30$$

No. of Asians left → 20%

$$20\% \rightarrow 30 \times 2 = \underline{60}$$
 [M1, A1]