



NAN HUA PRIMARY SCHOOL
CONTINUAL ASSESSMENT 2 2010
PRIMARY FOUR
SCIENCE

Name : _____ ()

Class : Primary 4 / _____

Date : 25 August 2010

Duration : 1 hr 30 min

Parent's Signature : _____

MARKS	
Sect A:	/ 40
Sect B:	/ 40
Total :	/ 80

Section A: (20 x 2marks = 40marks)

For each question from 1 to 20, four options are given. One of them is the correct answer. Make your choice (1, 2, 3 or 4). Shade the correct oval (1, 2, 3 or 4) on the Optical Answer Sheet.

1. Which of the following items is not a matter?

- (1) Flour
- (2) Music
- (3) Rain drops
- (4) Earthworm

2. Which of the following statements about matter are true?

- A: All matter can be seen.
- B: Only solids and liquids are matter
- C: All matter has mass and occupies space.
- D: Only one state of matter has a definite shape.

- (1) A only
- (2) A and B
- (3) B and C
- (4) C and D

3. Which state(s) of matter has/have a fixed volume?

- (1) Solid only
- (2) Liquid and gas only
- (3) Solid and liquid only
- (4) Solid, liquid and gas

4. Peter wanted to find out about the properties of a given Matter X. He placed 150g of Matter X in container P and Q respectively. He discovered that the volume of Matter X in both containers was the same.

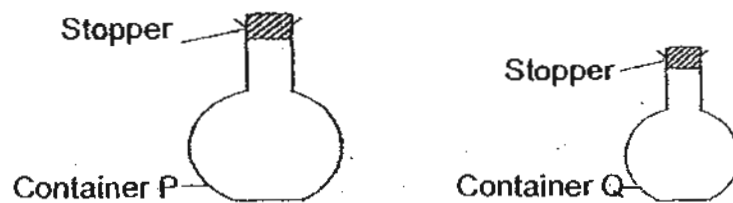

Which of the follow^{ing} is/are most likely to be Matter X?

- A: Solid
 - B: Liquid
 - C: Gas
-
- (1) B only
 - (2) C only
 - (3) A and B only
 - (4) B and C only

5. Dan measured his body temperature in his room as shown in the diagram below. His room's temperature is 30°C .

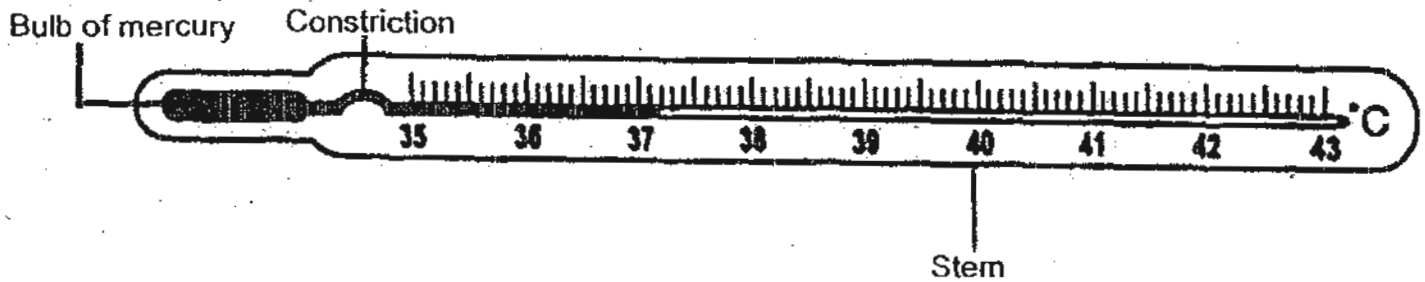

What is his body temperature?

- (1) 30.0°C
 - (2) 35.0°C
 - (3) 37.2°C
 - (4) 43.2°C
6. Why do we use mittens to carry hot utensils in the kitchen?



- (1) Mittens can keep the food hot.
 - (2) Mittens allow heat to escape easily.
 - (3) Mittens are poor conductors of heat.
 - (4) Mittens can conduct cold air to our hands.
7. Which of the following does not produce both heat and light?
- (1) Fire
 - (2) Star
 - (3) Boiled water
 - (4) Candle flame

8. Which of the following items are classified correctly?

	transparent	translucent	opaque
(1)	mirror	tissue paper	food film wrap
(2)	food film wrap	sunglasses	mirror
(3)	reading spectacle lens	frosted glass	sunglasses
(4)	sunglasses	tissue paper	frosted glass

9. The diagram below shows a melting popsicle.



Which of the following states the change in the properties of the popsicle correctly?

	change in state of matter	change in shape	change in volume
(1)	√		
(2)	√	√	
(3)			√
(4)		√	√

10. Study the flowchart below.

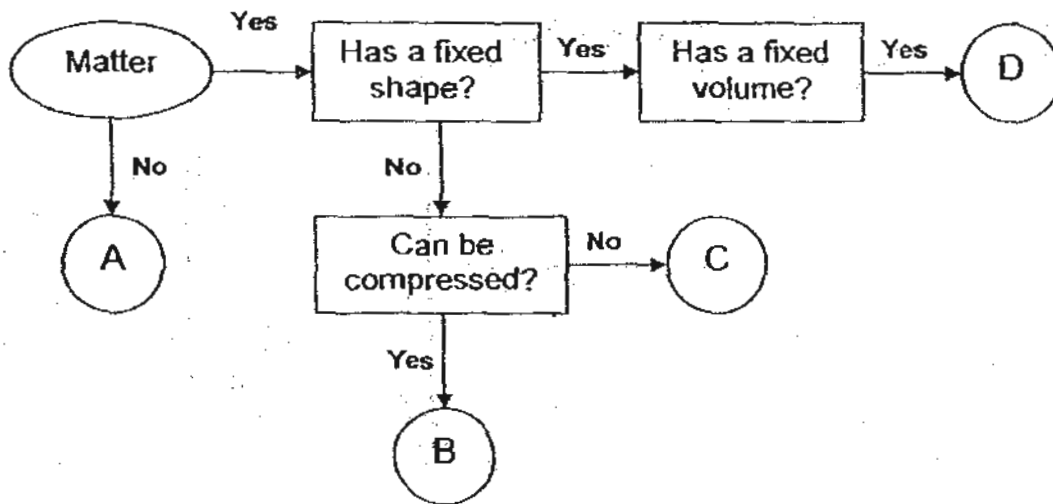

What of the following items best represent A, B, C and D respectively in the flowchart above?

	A	B	C	D
(1)	Shadow	Wind	Milk	Brick
(2)	Wind	Sponge	Dew	Shadow
(3)	Sponge	Brick	Ice	Wind
(4)	Ice	Dew	Shadow	Milk

11. John carried out an experiment where he filled a beaker with water up to its brim. Then he put a stone into it and recorded his observation as shown in the diagram below.

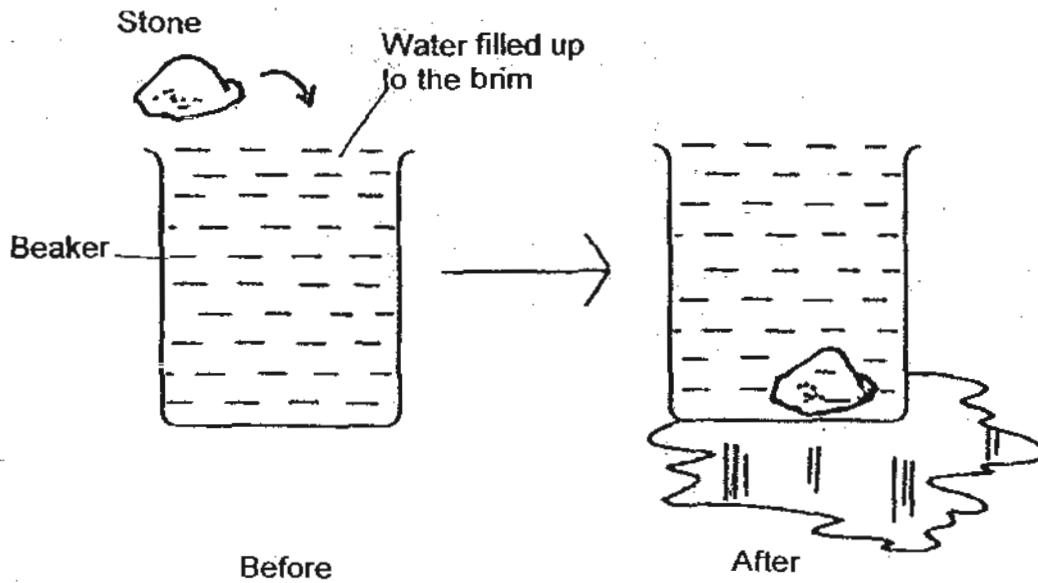

Which of the following conclusions can he draw from his observation?

- (1) The stone has mass.
- (2) The stone occupies space.
- (3) The stone has a definite volume.
- (4) The stone cannot be compressed.

12. The following items, W, X, Y and Z, are placed on the balance as shown below.

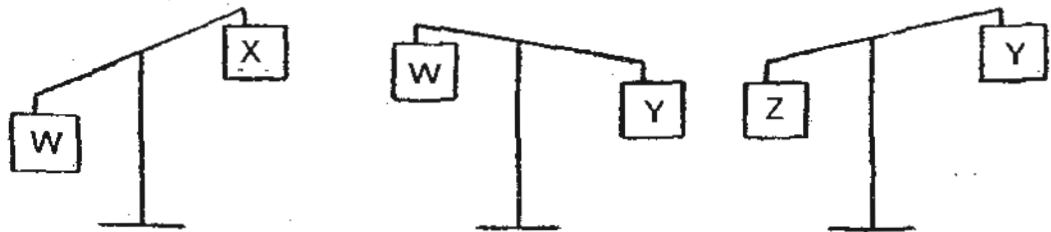

They are then arranged based on their mass. Which of the following shows correctly the arrangement of the mass starting from the smallest?

- (1) W, X, Y, Z
- (2) X, W, Y, Z
- (3) Y, X, Z, W
- (4) Z, Y, W, X

13. The diagram below shows a glass bottle containing 300 cm^3 of air and a syringe containing 50 cm^3 of air.

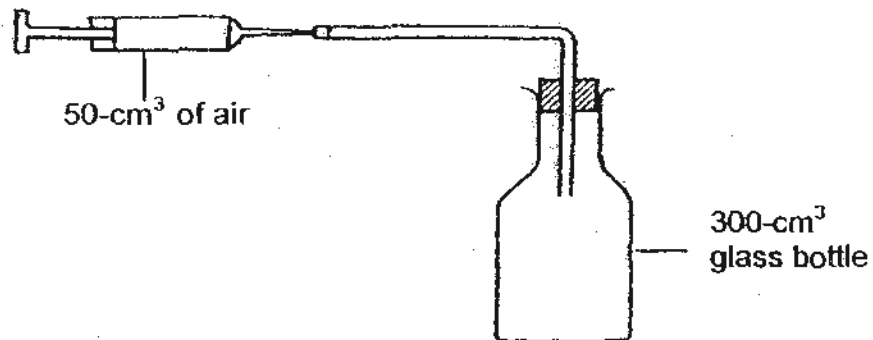

What would be the volume of air in the glass bottle when all the air in the syringe is pumped into the glass bottle?

- (1) 50 cm^3
- (2) 250 cm^3
- (3) 300 cm^3
- (4) 350 cm^3

14. Sally prepared a set-up by putting some ice cubes in a bowl. She then placed it on a weighing scale and took the reading as shown in the diagram below.

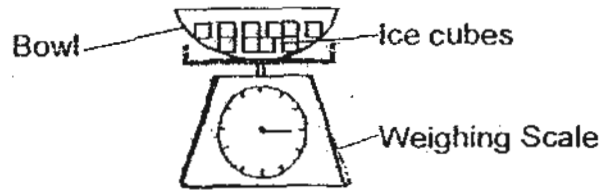

She then left the above set-up on the kitchen table for 1 hour with room temperature at 30°C. After 1 hour, all the ice cubes melted completely into water. She then weighed the set-up again and took the reading.

Which one of the following correctly shows the reading on the weighing scale?

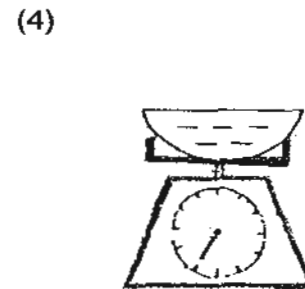
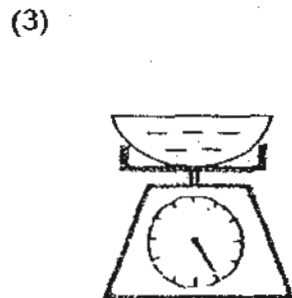
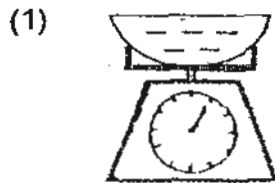

15. The diagram below shows two flasks that are connected by a glass tube. There is a drop of ink in the tube.

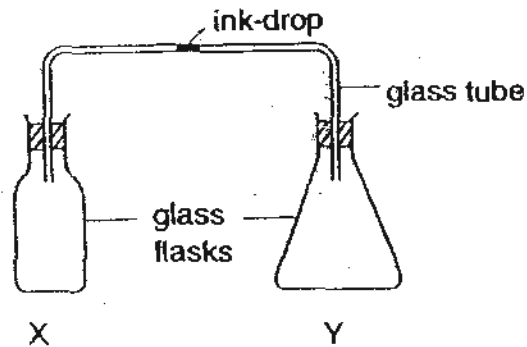

What should be done to the above set-up to move the ink -drop towards flask Y?

- (1) Put both flasks in cold water.
- (2) Put both flasks in very hot water.
- (3) Put flask X in cold water and flask Y in hot water.
- (4) Put flask X in hot water and flask Y in cold water.

16. Some ice cubes are added to hot tea as shown in the diagram below.

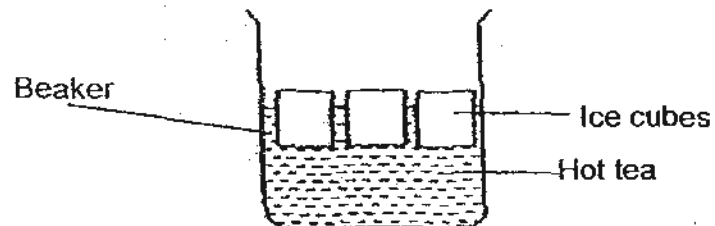

Which of the following changes are most likely to take place?

- A: The ice cubes lose coldness to the hot tea
- B: The ice cubes gain heat from the hot tea.
- C: The hot tea changes from liquid to solid state.
- D: The ice cubes changes from solid to liquid state.

- (1) A and B only
- (2) B and D only
- (3) C and D only
- (4) A, C and D only

17. Christopher poured ^{the} same amount of boiling water into four cups of the same shape and size. The four cups are made of different materials, A, B, C and D. He measured the changes in temperature of the water in the cups and recorded the results in the graph below.

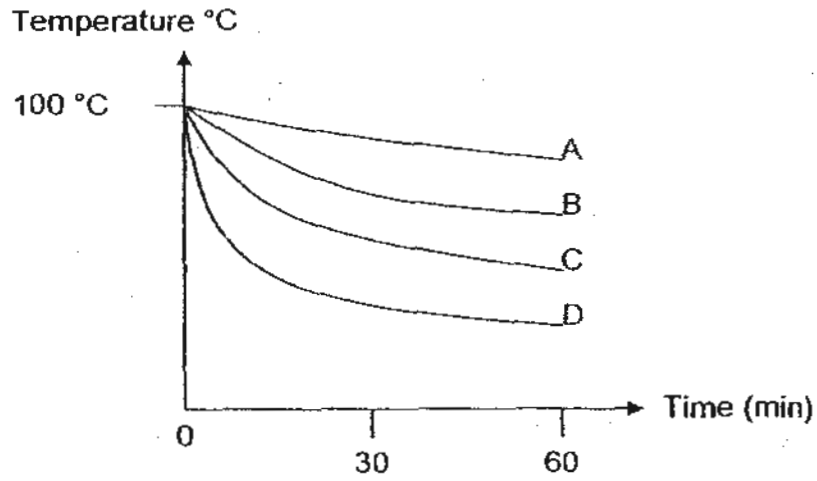

He then classified the materials according to their degree of heat conductivity. Which of the following is classified correctly?

	Poor heat conductor	Good heat conductor
(1)	A, B	C, D
(2)	B, C	D, A
(3)	C, D	A, B
(4)	B, D	A, C

18. Alex is facing his mirror and standing towards the right of the mirror in a brightly lit room. With the ceiling lamp lit above him, he can see the reflection of his toy in the mirror.

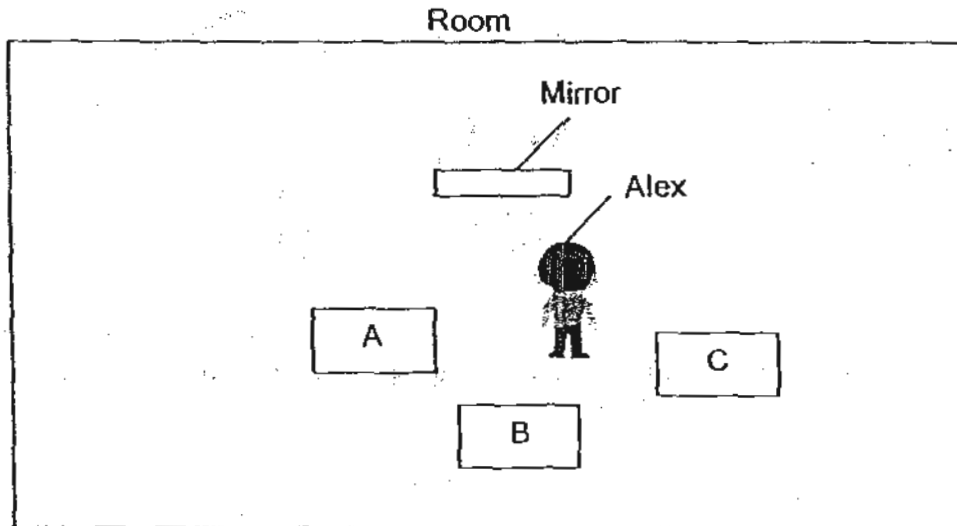

Which of the positions, A, B and C, will Alex's toy most likely be?

- (1) A and B only
- (2) B and C only
- (3) A and C only
- (4) A, B and C

19. John conducted the experiment in a room in complete darkness.

He has arranged sheets E, F, G and H in a straight line as shown in the diagram below. Each sheet is made of a different material. John has made a star shaped hole on E.

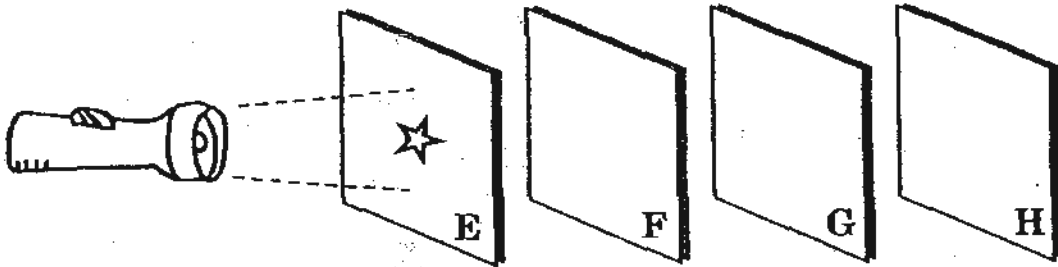

What type of materials should sheet E, F, G and H be for him to cast a faint shadow on sheet H?

	E	F	G	H
(1)	translucent	transparent	transparent	translucent
(2)	opaque	transparent	translucent	opaque
(3)	transparent	transparent	translucent	opaque
(4)	opaque	translucent	transparent	translucent

20. The following diagram shows the shadows (A, B, C and D) of the poles at different times of the day respectively.

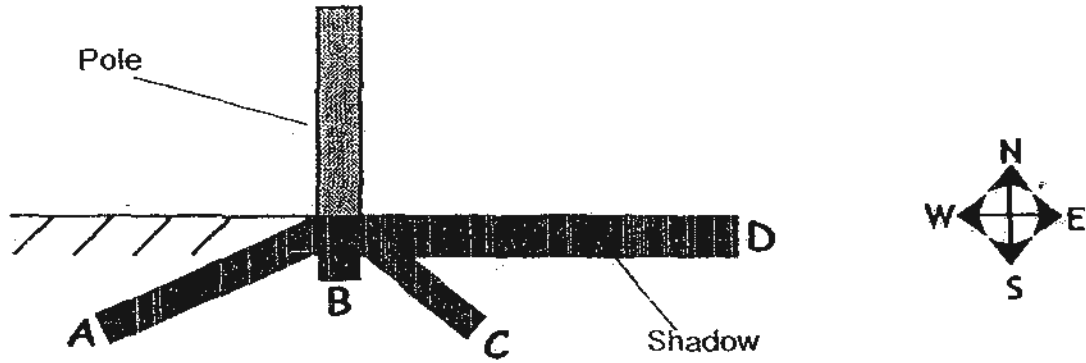

Which of the following correctly shows the shadow cast at 6p.m.?

- (1) A
- (2) B
- (3) C
- (4) D



NAN HUA PRIMARY SCHOOL
CONTINUAL ASSESSMENT 2 2010
PRIMARY FOUR
SCIENCE

Name : _____ ()

Class : Primary 4 / _____

MARKS	
40	

Section B: (40marks)

Write your answers to question 21 to 34.

The number of marks available is shown in brackets [] at the end of each question or part question.

21. James set up the experiment as shown below. He pushed the plunger of the syringe and managed to insert all 500cm^3 of Substance X into the tank. When he repeated the experiment with Substance Y, he could not insert all the Substance Y into the tank.

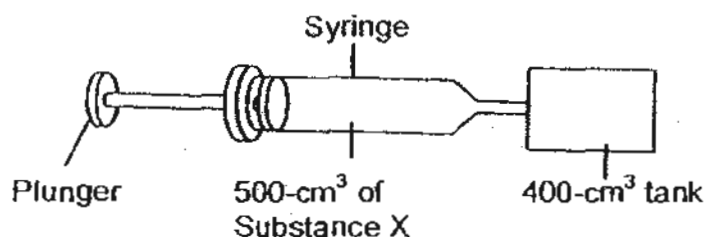

- (a) What can you conclude about the properties of Substance X and Y? [2]

- (b) Give an example of Substance X and Y [1]

X: _____

Y: _____

Score	3
-------	---

22. An ice cube was left on a table in room temperature of 30°C . The ice started to melt as shown in the diagram below.

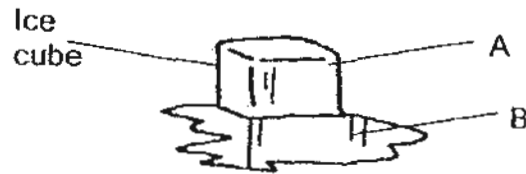

- (a) Name the state of matter labelled A and B respectively. [1]

A: _____

B: _____

- (b) Based on your answer in (a), state a difference in the property between the two states of A and B. [2]

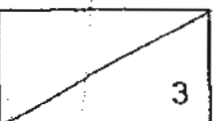
Score	
-------	---

23. Sally poured one litre of water from the bottle into the beaker as shown below.

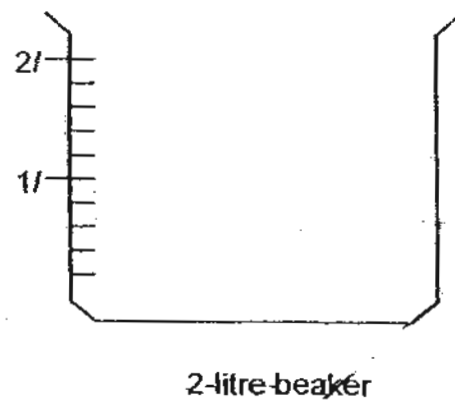
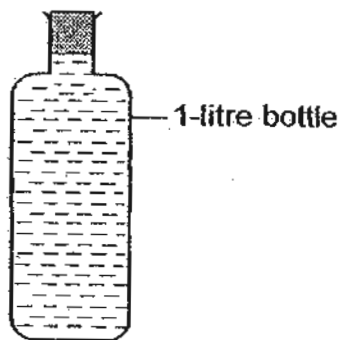

- (a) In the diagram above, draw a line in the beaker to show the water level after the water from the bottle has been transferred into it. [1]
- (b) From your answer in (a), what can you conclude about the property of water? [1]

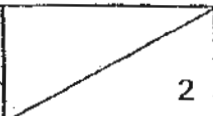
Score	
	2

24. Ali placed the following set-ups in an air-conditioned room with a temperature of 16°C as shown in the diagram.

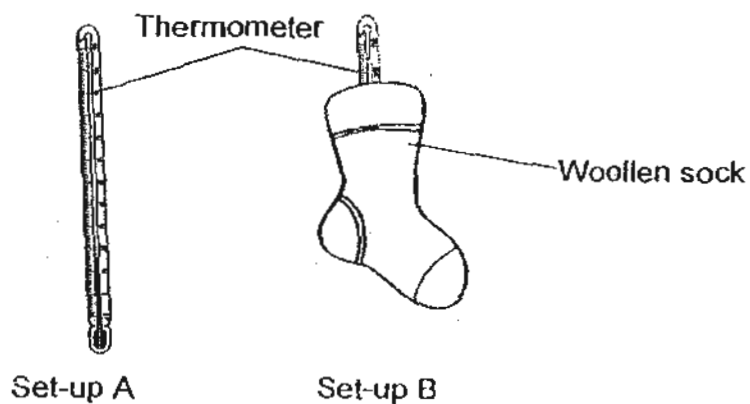

He predicted that the temperature recorded by the thermometer in Set-up B will be higher than that in Set-up A after 1 hour.

- (a) Do you agree with him? Give a reason for your answer. [2]

- (b) What is most likely to be the temperature recorded by the thermometer in Set-up B if the same experiment is repeated where the woollen sock is replaced by a metal tin? [1]

Score	3
-------	---

25. Classify the following correctly into the classification table below.

[3]

Aluminium foil	Stars	Moon
Mirror	Torch	Lamp post

Light source	Non-light source

Score	3
-------	---

26. Peter conducted an experiment to test if air is a matter. He hung two balloons, X and Y, at both ends of a pole and observed that the set-up was balanced as shown in the diagram below.

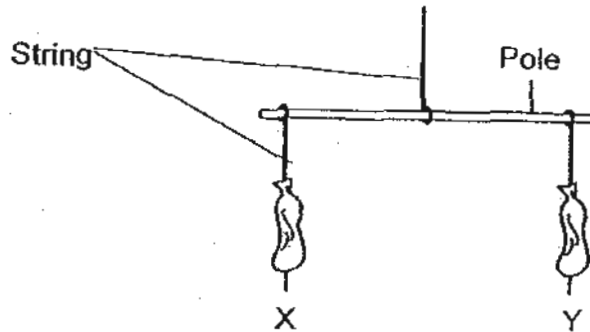

- (a) Describe what would be observed to the set up when Balloon X is inflated. [1]

- (c) Based on your answer in (a), what can you conclude about the property of air? [1]

Score	2
-------	---

27. Dave conducted an experiment to test which setup allows water to flow into the container more quickly. He prepared set-up A and B as shown in the diagram below. He then slowly poured the water from the beaker into the funnel of set-up A and B respectively.

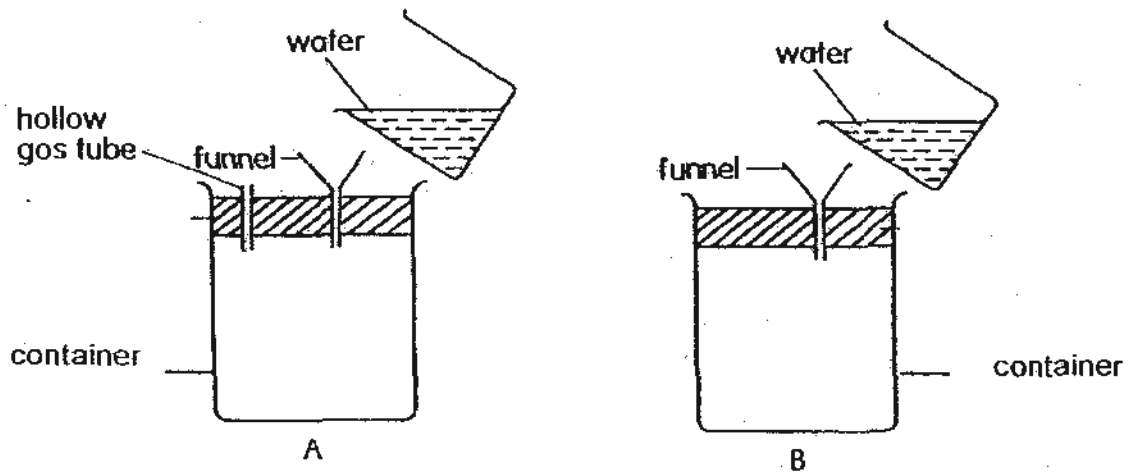

- (a) Which setup allows water to enter the container faster? [1]

- (b) Explain your answer in (a). [2]

Score	3
-------	---

28. Dan gently placed a ball of plasticine into a beaker containing 100 cm^3 of water. The volume of the plasticine and water is shown in the diagram below.

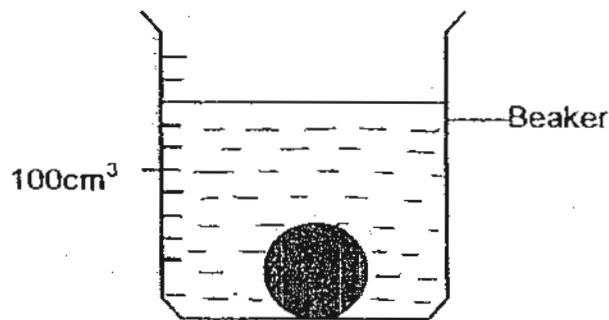

- (a) What is the volume of the plasticine? [1]

After that, he took the same plasticine and moulded it into the shape of a triangle before he placed it into another identical beaker containing 100 cm^3 of water.

- (b) What would the new volume observed ^{ve} when he lowered the triangular plasticine into the beaker gently? Explain your answer. [2]

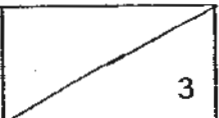
Score	
-------	---

29. Mary failed to fit a plastic ruler into an iron ring. She then heated the iron ring and managed to fit the plastic ruler within the ring as shown in diagram 2.

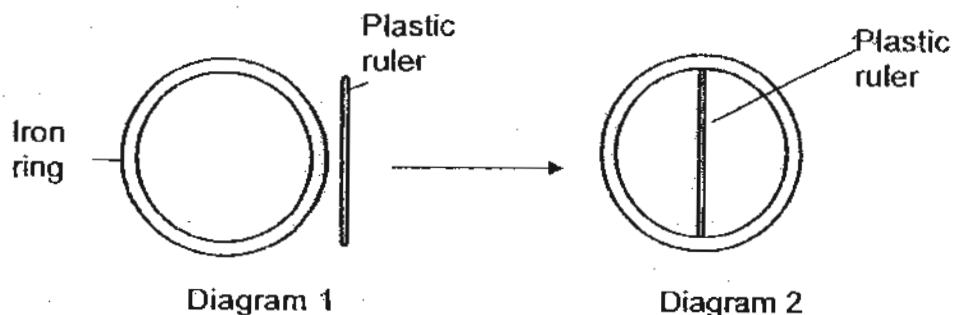

- (a) Put a tick in the box below to indicate the item(s) that gained or lost heat respectively. [1]

Items	Gain heat	Lost heat
Ring		
Plastic ruler		

- (b) When the heat is removed from the iron ring in Diagram 2, what would happen to the plastic ruler within it after half an hour? [1]

- (c) Explain your answer in (b). [2]

Score	4
-------	---

30. Fred left a cup of lukewarm water in an air conditioned room for ten minutes. He recorded the temperature of the water in the table below.

Time (min)	Temperature (°C)
0	30
2	26
4	24
6	22
8	20
10	20
14	?

- (a) Plot a line graph according to the results shown in the table above. [3]

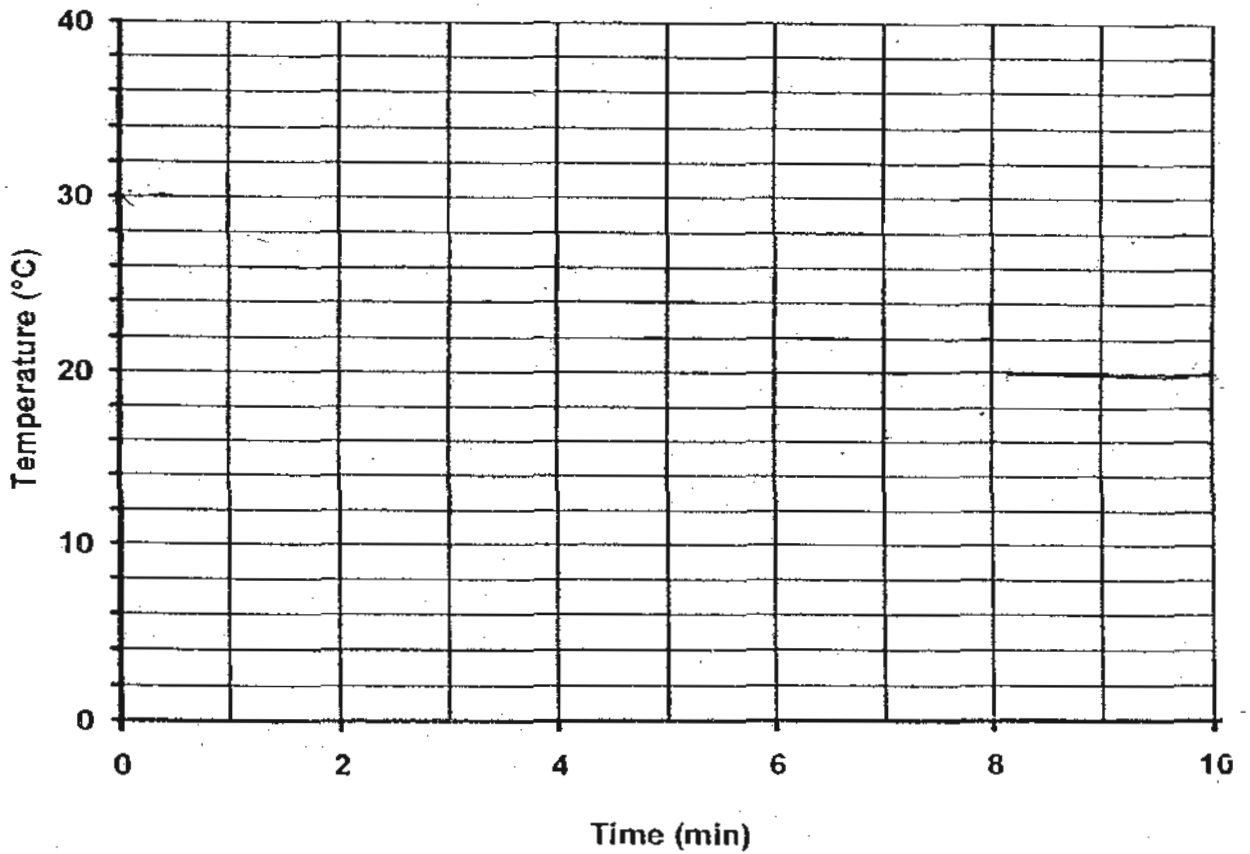

- (b) Predict the temperature of the water recorded at 14th minute. [1]

Score	4
-------	---

31. Caiwei wanted to determine which metal, Rod A and B, is a better conductor of heat. She inserted equal lengths of both ends of the rods into a tank of hot water and attached identical nails to the rods using the same amount of wax. She set up the experiment as shown below.

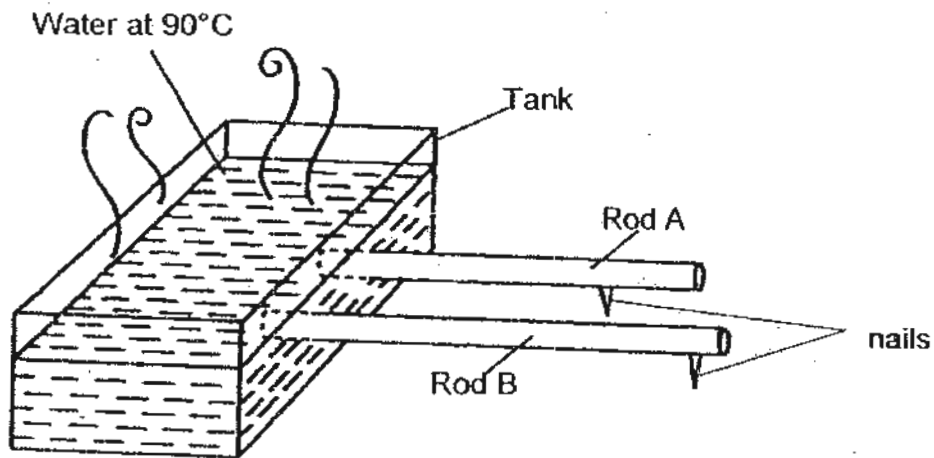

Her friend told her that her set up is incorrect. Suggest two changes she should make to the set-up in order to conduct a fair test. [2]

(a) _____

(b) _____

Score	2
-------	---

32. Two men are walking together to hire a taxi at night. Man X is wearing a white suit, while Man Z is wearing a black suit. A taxi is approaching them from a distance.

- (a) Which man, X or ~~X~~^Z, would the taxi driver see more clearly from a distance at night? Explain your answer. [2]

- (b) On the diagram below, draw ^{the} ray of light to show how light from the car's headlamp reaches the driver so that he can see the man stated in your answer in (a). [1]

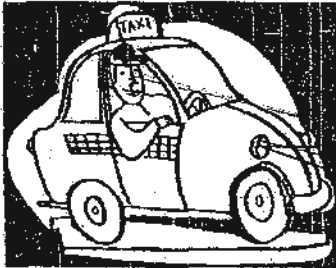

Man Z



Man X

Score	3
-------	---

33. Jamie used a light sensor connected to a computer to measure the amount of light that was able to pass through different materials, A, B and C as seen in the diagram below.

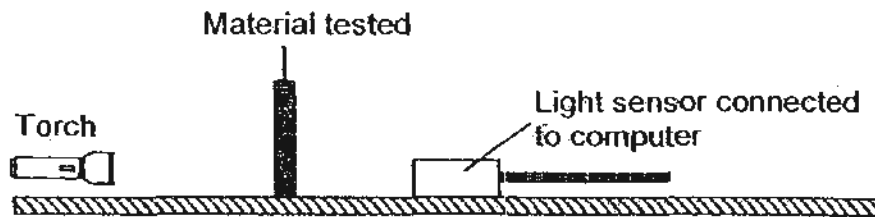

Jamie recorded the results in the table below.

Material	Amount of light (Lux)
A	80
B	0
C	330

- (a) Arrange the materials in accordance to the degree of transparency starting from the least transparent.

[1]

- (b) Which material will produce a faint shadow when placed in between a light source and a screen?

[1]

- (c) Explain your answer in (b).

[1]

Score	3
-------	---

34. Alvin wanted to test if the position of an object affects the length of its shadows. He placed a wooden block in between a torch and a screen as shown in the diagram below. Then he measured the height of the shadow cast on the screen. Next, he repeated the experiment in different positions by adjusting the distance between the screen and the wooden block.

Alvin recorded the results of the experiment in the table below.

Position	Height of shadow
X	17 cm
Y	20 cm
Z	14 cm

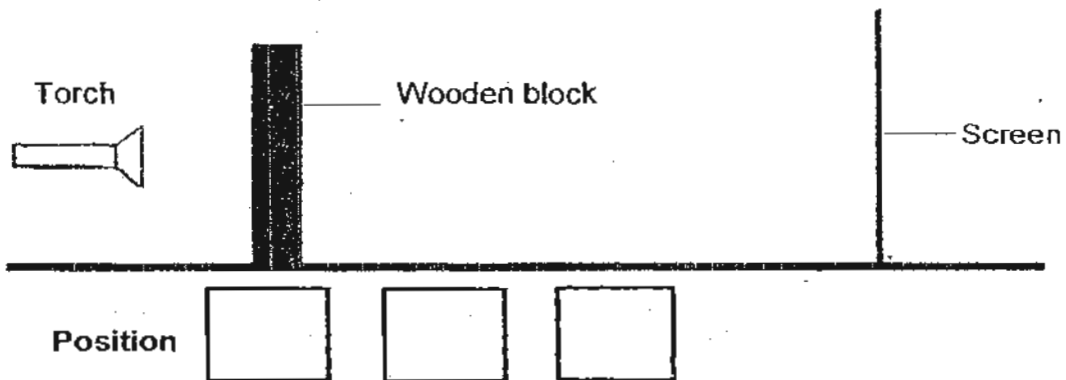

- (a) Label the different positions (X, Y or Z) of the wooden block in the diagram based on the results in the table above. Write them in the boxes provided. [1]

- (b) From the results in the table, what is the relationship ^{between the distance of} ~~between the screen;~~ ^{the wooden block and the height of the shadow?} ~~the wooden block from the screen and the height of the shadow?~~ ^{the shadow?} [1]

End of Paper

Score	2
-------	---

ANSWER SHEET

EXAM PAPER 2010

SCHOOL : NAN HUA PRIMARY
SUBJECT : PRIMARY 4 SCIENCE

TERM : CA2

Q1	Q2	Q3	Q4	Q5	Q6	Q7	Q8	Q9	Q10	Q11	Q12	Q13	Q14	Q15	Q16	Q17
2	4	3	3	3	3	3	2	2	1	2	2	3	2	4	2	1

Q18	Q19	Q20
1	2	4

21)a) Substance X is a gas as gas can be compressed and substance Y is a liquid cannot be compressed.

b) X: air Y: water

22)a) A: solid B: liquid

b) Matter A has a fixed shape but matter B does not have a fixed shape.

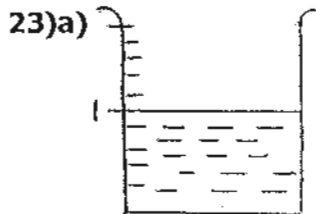

b) Water has a fixed volume.

24)a) I disagree with alive. The woolen sock is not a heat source so it will not cause the thermometer in the sock to increase.

b) 16°C

25) Light source

Torch
Stars
Lamp post

Non-light source

Aluminium foil
Mirror
Moon

26)a) The side of the pole with balloon X will tilt downwards.

b) Air has mass.

27)a)A.

b)Water in set-up A flows more quickly as the air in the container is able to escape through the hollow gas tube and allow the water to occupy the space. In set-up B the air occupying the space is not able escape. Thus preventing water from entering quickly.

28)a)60cm³.

b)160cm³. The plasticine has a fixed volume but no fixed shape so the triangle plasticine is also the circle plasticine.

29)a)Gain heat Gain heat

b)The ruler will break.

c)The Iron ring lost heat to the surroundings air and contracts. The plastic ruler will not be able to fit in the smaller ring.

30)a)

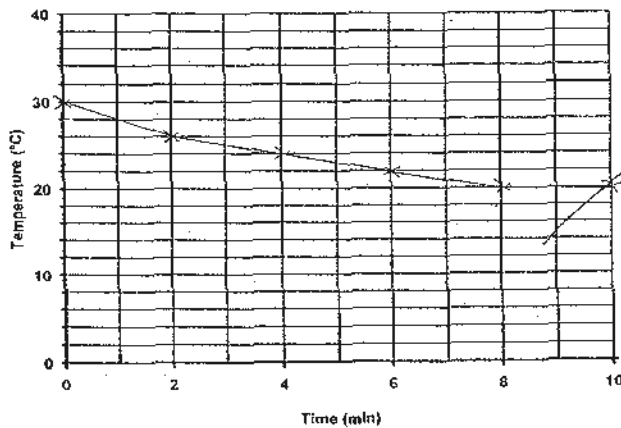

b)20°C.

31)a)The rod should be the same length.

b)Position the nails in the same position on both rod.

32)a)The driver could see Man X more dearly as his white suit reflects more light from the head lamp into the drivers eyes than the black suit of Man Z.

b)

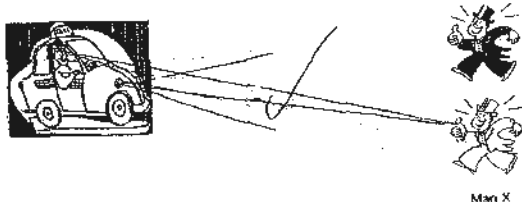

33)a)B, A, C. b)A.

c)Material A is translucent it only blocks the path of light spastically so it forms a faint shadow.

34)a)Y,X,Z.

b)The further the distance of the wooden block from the screen the longer the height of the shadow.