

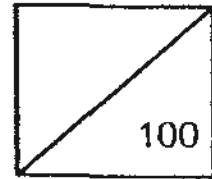

Rosyth School  
First Semestral Assessment for 2010  
SCIENCE  
Primary 4



Total  
Marks:

Name: \_\_\_\_\_

Class: Pr \_\_\_\_\_

Register No. \_\_\_\_\_

Duration: 1 h 30 min

Date: 13<sup>th</sup> May 2010

Parent's Signature: \_\_\_\_\_

---

## BOOKLET A

Instructions to Pupils:

1. Do not open the booklets until you are told to do so.
2. Follow all instructions carefully.
3. This paper consists of 2 booklets, Booklet A and Booklet B.
4. For questions 1 to 30 in Booklet A, shade the correct ovals on the Optical Answer Sheet (OAS) provided using a 2B pencil.
5. For questions 31 to 44, give your answers in the spaces given in the Booklet B.

	Maximum	Marks Obtained
Booklet A	60 marks	
Booklet B	40 marks	
Total	100 marks	

\* This booklet consists of 16 pages.

*This paper is not to be reproduced in part or whole without the permission of the Principal.*

**Part 1 (60 MARKS)**

For each question from 1 to 30, four options are given. One of them is the correct answer. Make your choice (1, 2, 3 or 4). Shade the correct oval (1, 2, 3 or 4) on the Optical Answer Sheet.

1. Why do animals need to move about?

- A: To reproduce
- B: To look for food
- C: To escape from danger

- (1) A and B only
- (2) A and C only
- (3) B and C only
- (4) A, B and C

2. Four pupils caught an animal and were trying to decide if the animal was an insect.

Anastacia said, "It is an insect because it has three body parts."

Benedict said, "It is an insect because it can swim."

Charmaine said, "It is an insect because it has 6 legs."

Desmond said, "It is an insect because it is brown in colour."

Who was/were correct?

- (1) Anastacia only
- (2) Benedict and Desmond only
- (3) Charmaine and Desmond only
- (4) Anastacia and Charmaine only

3. Which of the following statements is correct?

- (1) Living things need air, food and water.
- (2) Non-living things can grow and reproduce.
- (3) Living things like plants cannot reproduce.
- (4) Non-living things can move by themselves.

4. Look at the classification chart below.

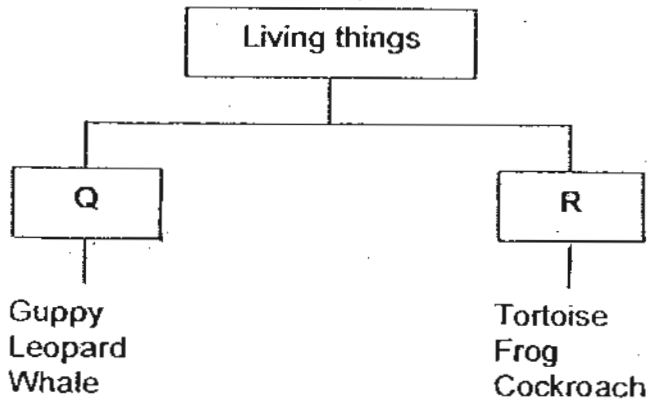

Which one of the following can be placed under R?

- (1) Rabbit
- (2) Elephant
- (3) Dolphin
- (4) Spiny anteater

5. How is a mushroom similar to a hibiscus plant?

- A: Both bear flowers.
- B: Both need water to survive.
- C: Both respond to changes slowly.
- D: Both need sunlight to make food.

- (1) A and B only
- (2) A and D only
- (3) B and C only
- (4) A, B, C and D

6. Water enters a plant through its roots. Where does the water go to after entering the plant?

- A: Fruits
- B: Stems
- C: Leaves
- D: Flowers

- (1) A and C only
- (2) A and B only
- (3) C and D only
- (4) A, B, C and D

7. Refer to the flowchart below.

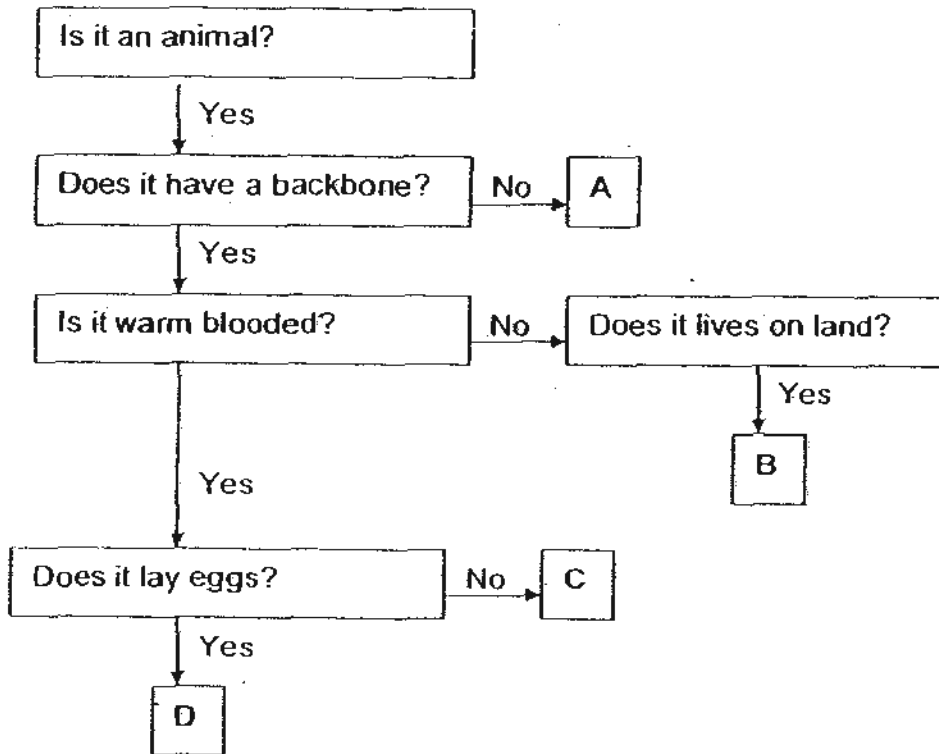

Based on the flowchart, which is definitely a mammal?

- (1) A
- (2) B
- (3) C
- (4) D

8. The table below describes the stages of life cycles of four animals.

Description	A	B	C	D
The young goes through a process called moulting.	No	Yes	No	Yes
The young looks like the adult.	Yes	No	Yes	No
Has three stages in its life cycle.	Yes	No	No	Yes

Which one of the following is likely to be a beetle?

- (1) A
- (2) B
- (3) C
- (4) D

9. The diagrams below show the life cycles of some animals.  
Which one of the life cycles below is different from the others?

(1)

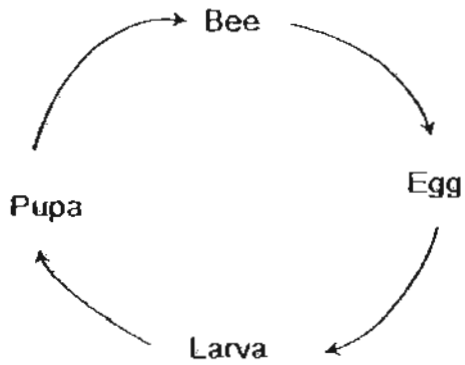

(2)

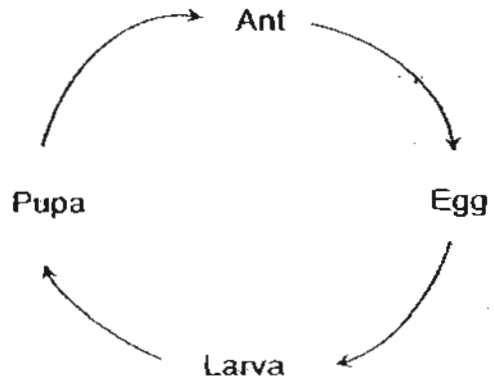

(3)

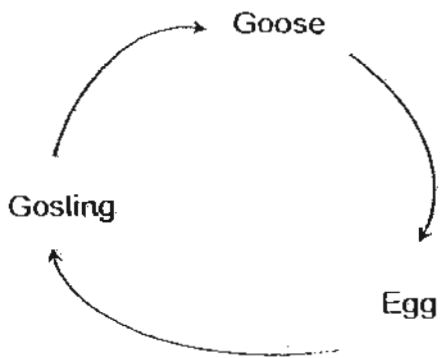

(4)

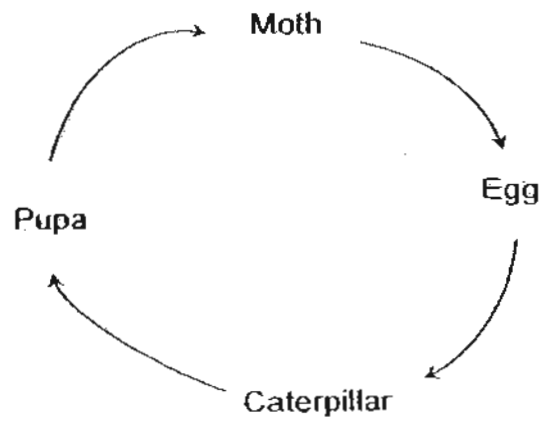

10. Which one of the following statements is true about the life cycle of a moth?

- (1) The young resembles the adult.
- (2) Wings develop during the pupa stage.
- (3) Legs are absent during the larva stage.
- (4) It feeds only during the pupa and adult stages.

11. Study the concept map below.

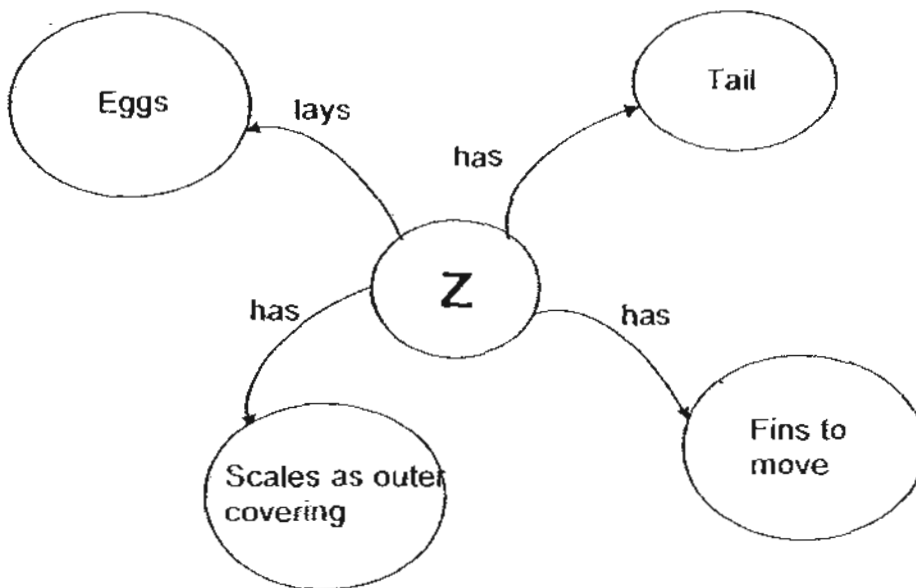

Which animal can Z be?

- (1) Frog
- (2) Parrot
- (3) Snake
- (4) Goldfish



15. The graph below shows the growth of a plant.

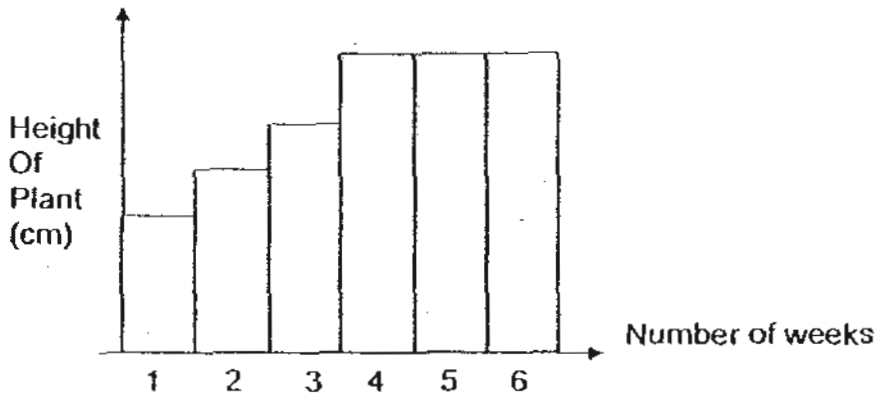

What does the graph tell you about the plant's growth over 6 weeks?

- (1) The plant grew shorter.
  - (2) The plant did not grow at all.
  - (3) The plant grew taller continuously.
  - (4) The plant reached its maximum height after 4 weeks.
16. Jimmy conducted an experiment as shown below. He used three metal balls A, B and C and they were balanced on a rod at the centre X.

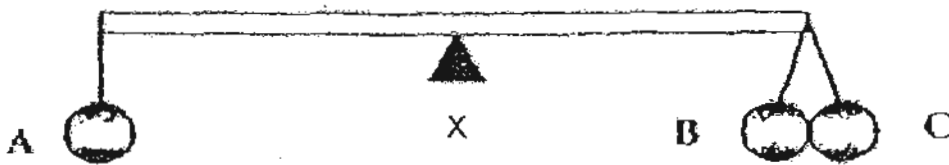

Which of the following are definitely true statements?

- A: Ball B has a smaller mass than Ball C.
  - B: Ball A has a greater mass than Ball B.
  - C: Ball A will move upwards when Ball B is removed.
  - D: Ball A has the same mass as the combined mass of Balls B and C.
- (1) A and B only
  - (2) B and D only
  - (3) C and D only
  - (4) B, C and D only

17. Which of the following is not matter?

- A: Light
- B: Smoke
- C: Electricity
- D: Water vapour

- (1) A and B only
- (2) A and C only
- (3) A, B and C only
- (4) B, C and D only

18. After buying a cabbage that weighs 350g, Jerry's mother cut the whole cabbage into smaller pieces. What is the mass of the cabbage after it was cut into smaller pieces?

- (1) 300g
- (2) 350g
- (3) 360g
- (4) 370g

19. Balloon A is filled with  $20\text{cm}^3$  of air while Balloon B is filled with  $60\text{cm}^3$  of air. The balloons are placed on a lever balance as shown below.

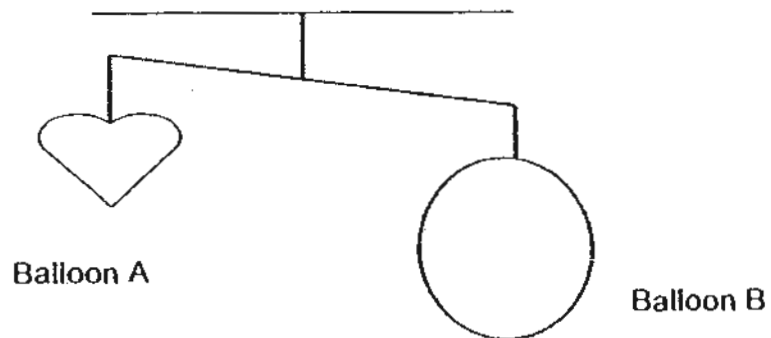

Which property/properties of air can be deduced by the above observation?

- A: Air has mass
- B: Air has indefinite shape
- C: Air can be compressed

- (1) A only
- (2) C only
- (3) A and B only
- (4) A, B and C



22. Refer to the flowchart below.

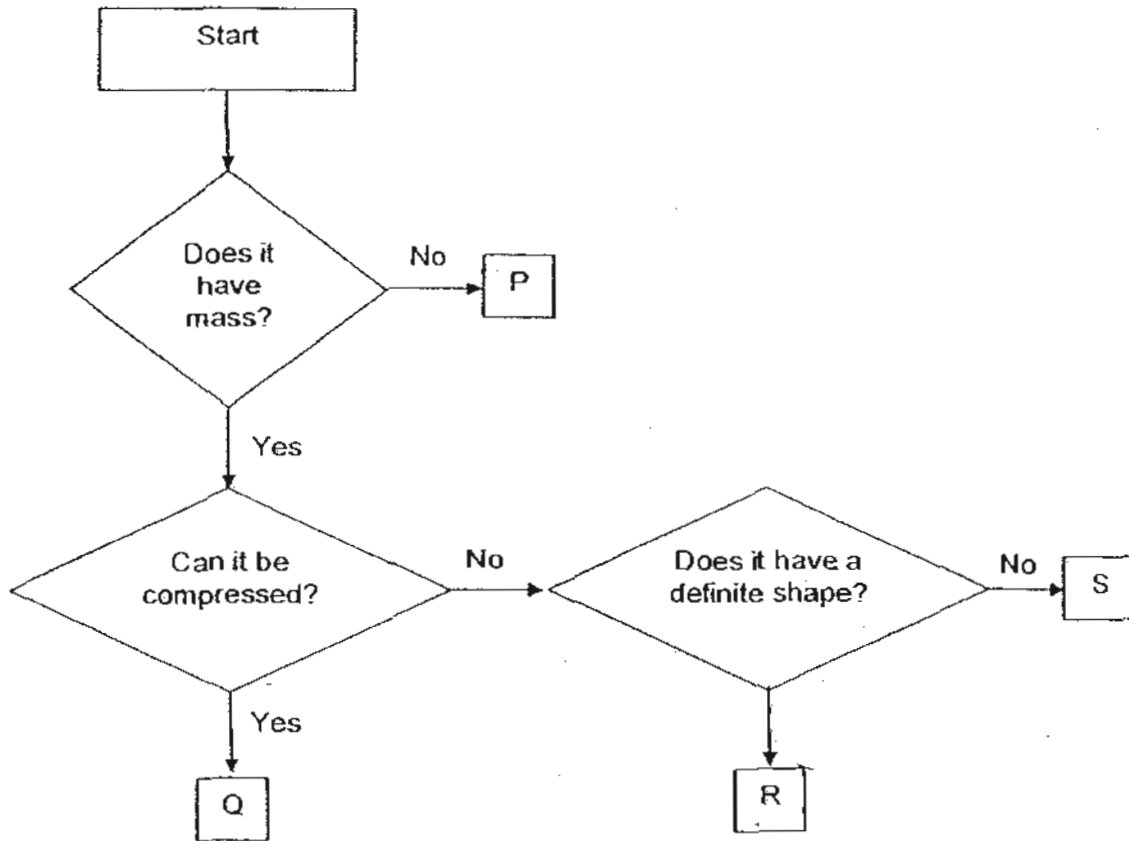

Which of the following is not a matter?

- |       |       |
|-------|-------|
| (1) P | (2) Q |
| (3) R | (4) S |

23. Siti filled a syringe with some water and air. The nozzle is then sealed tightly. She then pushed the plunger down as far as it could go. At which position will the plunger most likely be?

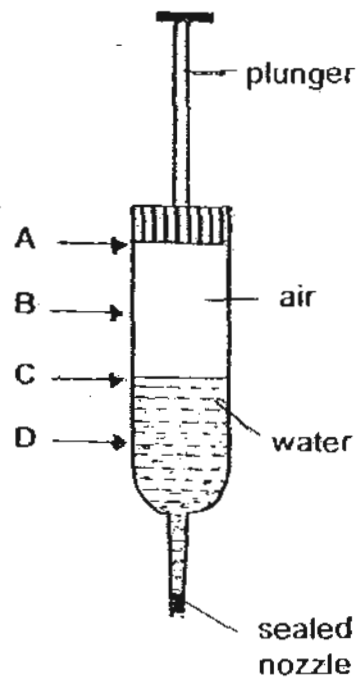

- (1) A  
(3) C

- (2) B  
(4) D



26. Which of the following is not a source of light?

- A. Sun
- B. Mirror
- C. Diamond
- D. Mobile phone

(1) A and B only

(2) B and C only

(3) A, B and C only

(4) B, C and D only

27. Melissa has classified some materials into three groups as shown below.

A	B	C
Glass	Tracing paper	Mirror
Clear plastic	Frosted glass	Cardboard

Which characteristic has Melissa used for her classification?

- (1) The colour of the materials
- (2) The texture of the materials
- (3) The usefulness of the materials
- (4) The transparency of the materials

28. Jean set up an experiment to find out how much light can pass through some materials (X, Y and Z). When a torch is shone, she observed the following on the screen.

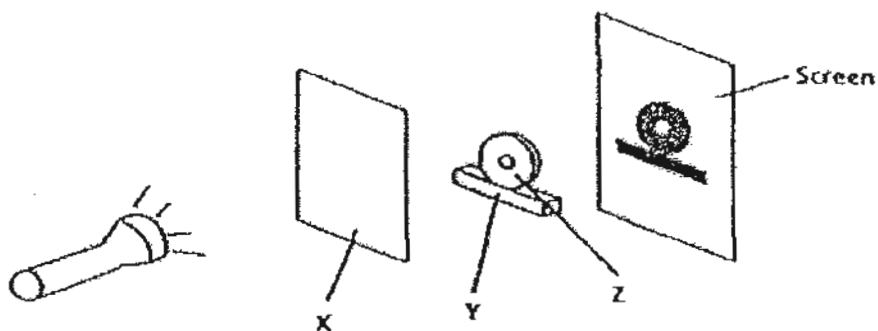

Which of the following properties are correctly matched to the above materials?

	Material X	Material Y	Material Z
(1)	Allows most light to pass through	Allows some light to pass through	Allows most light to pass through
(2)	Allows some light to pass through	Allows most light to pass through	Allows some light to pass through
(3)	Allows most light to pass through	Does not allow any light to pass through at all	Does not allow any light to pass through at all
(4)	Does not allow any light to pass through at all	Allows most light to pass through	Allows some light to pass through

29. Bala conducted an experiment to investigate the amount of light that can pass through three materials of the same thickness. The materials he used were frosted glass, clear plastic sheet and styrofoam board. He shone a torch through the three materials. He used a light sensor to measure how much light has passed through each of them.

He drew a graph to show the amount of light recorded by the light sensor. Which of the following graphs is correct ?

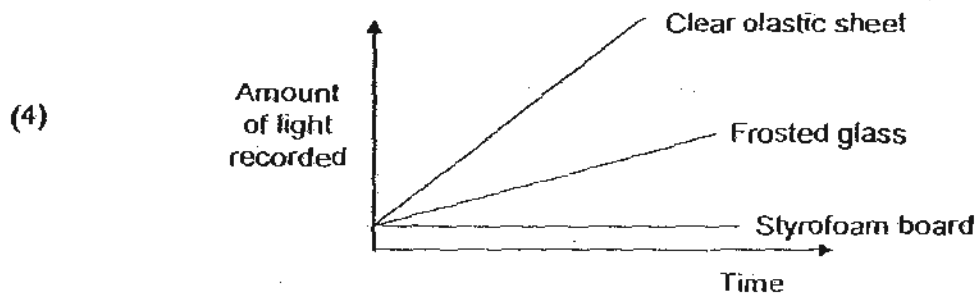
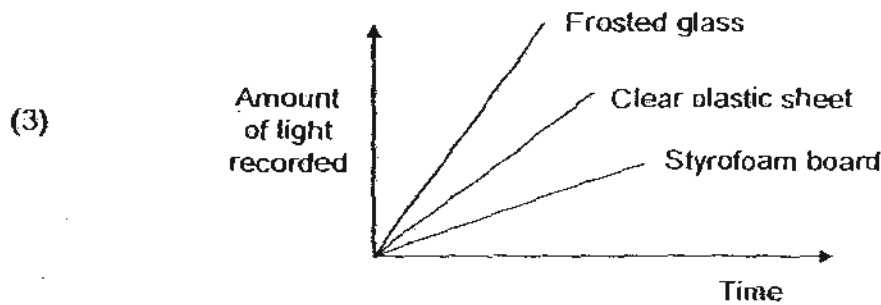
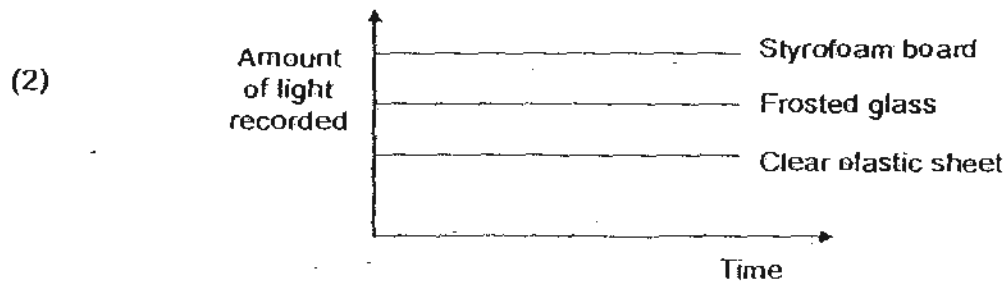
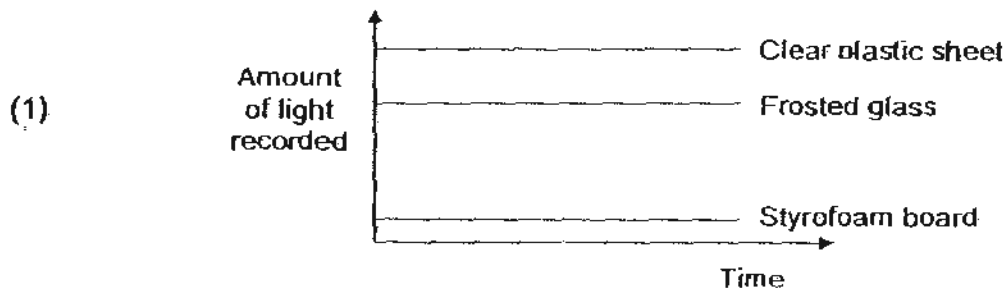





**Rosyth School**  
**First Semestral Examination for 2010**  
**SCIENCE**  
**Primary 4**

Total  
Marks:

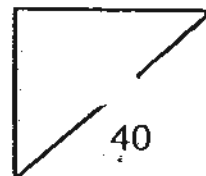

Name: \_\_\_\_\_

Class: Pr \_\_\_\_\_

Register No. \_\_\_\_\_

Duration: 1 h 30 min

Date: 13 May 2010

Parent's Signature: \_\_\_\_\_

---

## **BOOKLET B**

Instructions to Pupils:

1. For questions 31 to 44, give your answers in the spaces given in this Booklet B.

\* This booklet consists of 14 pages.

This paper is not to be reproduced in part or whole without the permission of the Principal.

**PART II (40 MARKS)**

For questions 31 to 44, write your answers in this booklet.

31. Plants A, B, C and D have the following characteristics.

Characteristics	Plant A	Plant B	Plant C	Plant D
Grows on land	Yes	No	No	Yes
Bears flowers	No	Yes	No	Yes

a) Write A, B, C and D in the empty boxes provided below. (2m)

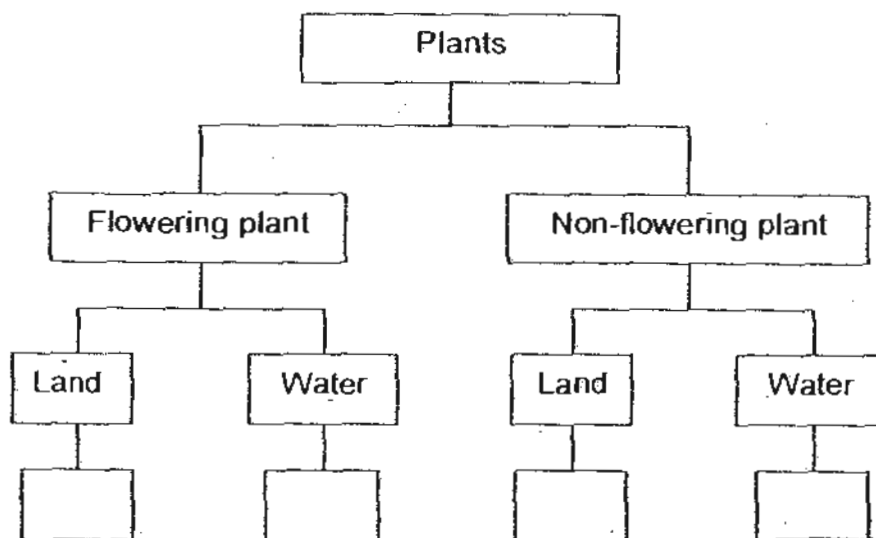

b) Based on the classification chart above, state one similarity between Plants B and C. (1m)

---



---

32. The table below shows four groups of living things A, B, C and D and their characteristics. (4m)

Animal			
A	B	C	D
- has 3 body parts - lay eggs - has a pair of feelers	- has scales - has gills - most lay eggs	- has hair - gives birth to young alive - produces milk	- has beak - has feathers - lay eggs

Name the four groups of animals:

A: \_\_\_\_\_

B: \_\_\_\_\_

C: \_\_\_\_\_

D: \_\_\_\_\_

33. Below are pictures of two living things.



A



B

a) How are the two living things similar in the way they get their food? (1m)

---

---

b) Based on the above diagram, state one way on how they differ. (Do not compare shape and size). (1m)

---

---

34. Study the classification chart below.

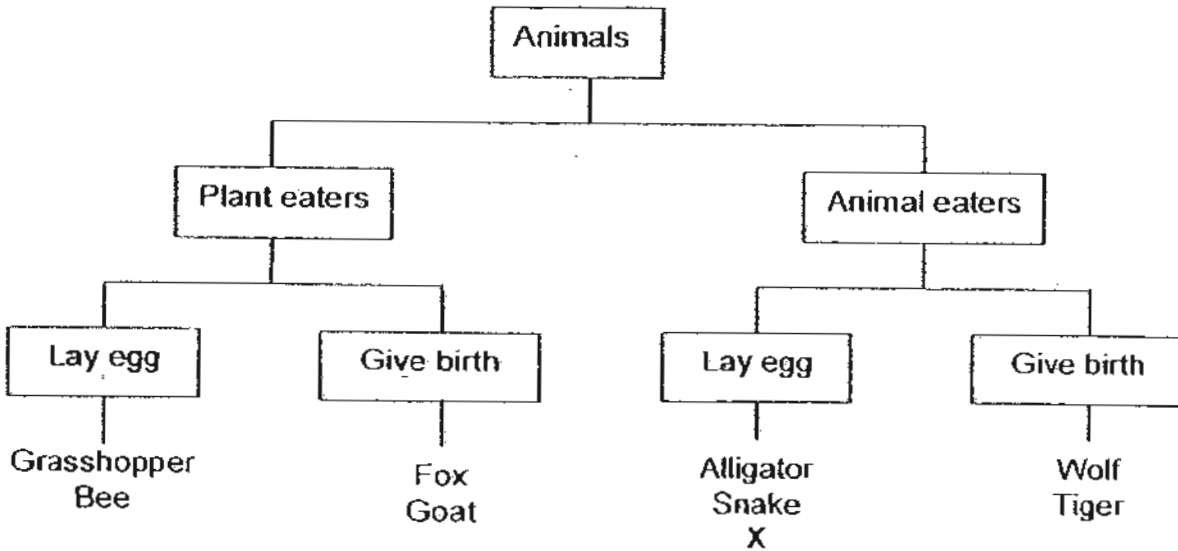

a) From the classification chart above, state two characteristics of Animal X. (2m)

---



---

b) Which animal is placed wrongly in the classification? Give reason for your choice. (1m)

---



---

c) Classify all the nine animals correctly in the table given below. (1m)

Lay Eggs		Gives Birth	
Plant-eaters	Animal-eaters	Plant-eaters	Animal-eaters

35. The diagram below shows the life cycle of a mosquito.

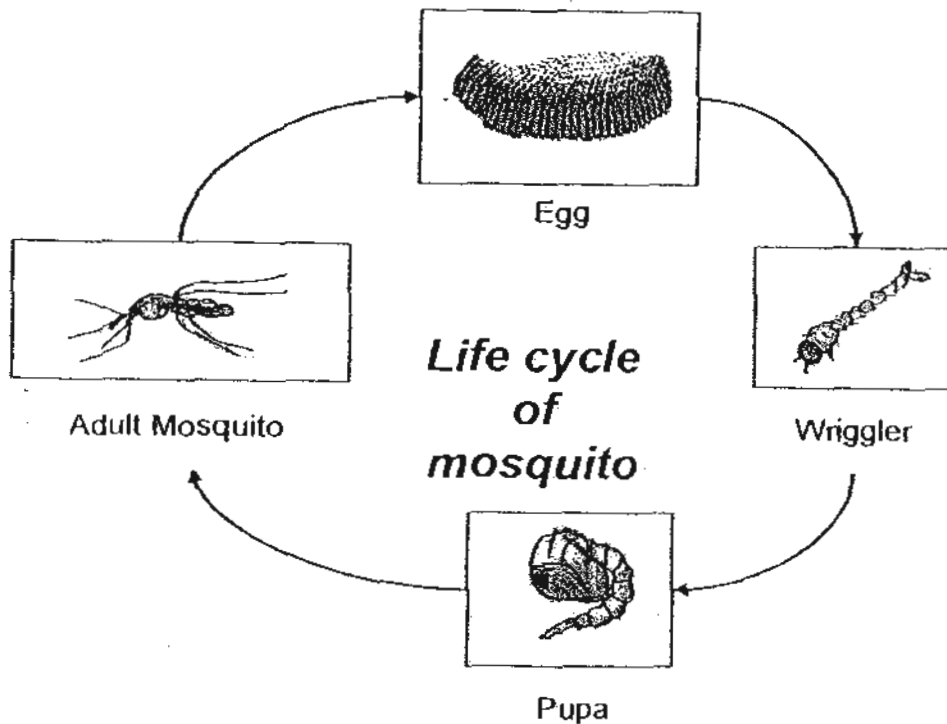

a) At which stage of the life cycle is the mosquito considered a pest? Explain why. (1m)

---

---

Ali and Dick were discussing the best way to stop the mosquito from multiplying.

Ali said, "The best way to get rid of mosquitoes is to use insecticides."

Dick said, "The best way is to get rid of stagnant water in the house."

b) Whose method is better? Give a reason for your answer. (1m)

---

---

36. The diagrams below show the life cycles of two animals.

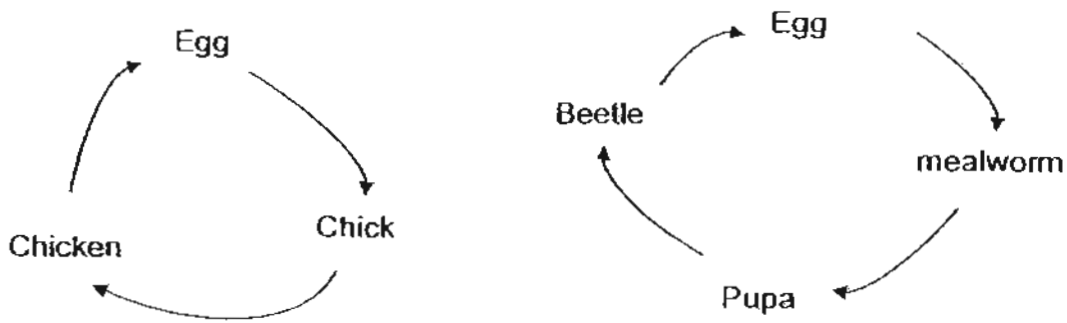

Based on the diagrams above,

a) list one difference between the life cycles of the chicken and the beetle? (1m)

---



---

b) list one similarity between the life cycles of the chicken and the beetle? (1m)

---



---

c) Four animals are classified into two groups based on their common characteristics of their life cycles as shown below.

Group P	Group Q
Chicken Pigeon	Beetle Butterfly

Suggest the headings for Group P and Q. (2m)

Group P: \_\_\_\_\_

Group Q: \_\_\_\_\_

37. The graph below shows the relationship between the height of the seedling and the mass of the seed leaves.

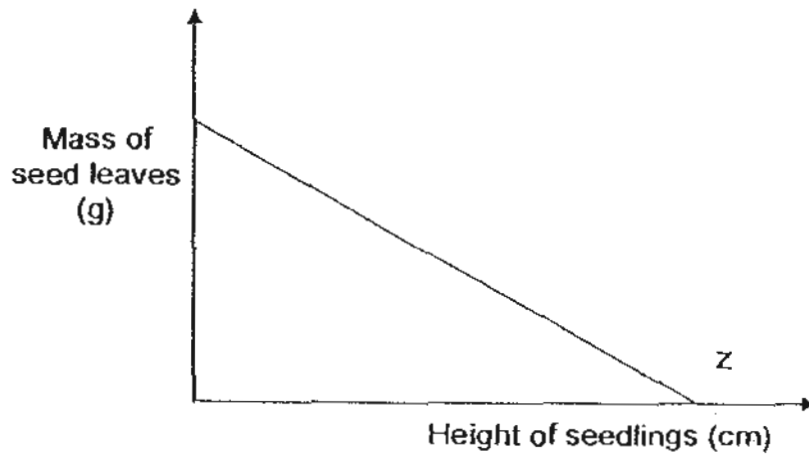

- a) Why did the mass of seed leaves decrease as the height of seedling increase? (1m)

---

---

- b) Which parts of the seedling would have developed at point Z? (1m)

---

38. Shirley prepared the set-ups E and F as shown below.

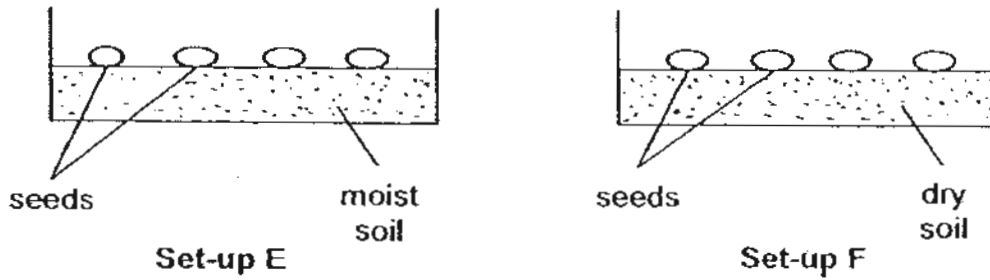

a) In which set-up will the seeds germinate? Support your choice. (1m)

---

---

b) Shirley also wanted to show that light is not needed for germination. Draw the set-ups to show that light is not needed for germination. Label your drawings too. (2m)

--	--

39. A ball of plasticine was put into a beaker containing 200 ml of water. The water rose to 350 ml, as shown in Figure T.

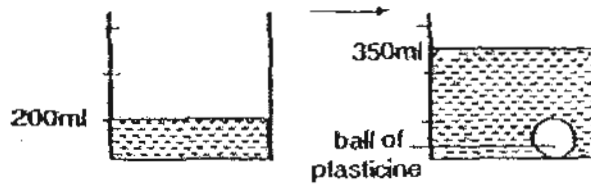

Figure T

- a) What is the volume of the ball of plasticine? (1m)

---

The ball of plasticine was taken and moulded into another shape. It was put back into the same beaker as shown in Figure U.

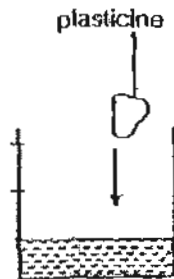
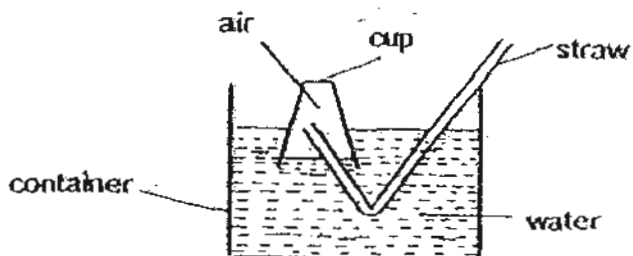

Figure U

- (b) What would be the water level be at Figure U? (1m)

---

40. Alice carried out an experiment using the set-up as shown in the diagram below.



a) What would happen to the water level in the cup when Alice sucks out some air through the straw? (1m)

---

b) Explain your answer in (a). (1m)

---

---

41. Celeste has set up an experiment as shown in the diagram below. She used four objects of similar size P, Q, R and S, to find out which object has the greater mass.



- a) Arrange the objects (P, Q, R and S) smallest mass to the biggest mass. (2m)



- b) Why the objects, P, Q, R and S have different masses? (1m)

---

---

42. Kelly carried out an experiment as shown in the diagram below. She cut off the bottom of a large plastic bottle and tied a plastic bag securely to the mouth of the bottle after removing the cap. She held the bottle over a large basin of water.

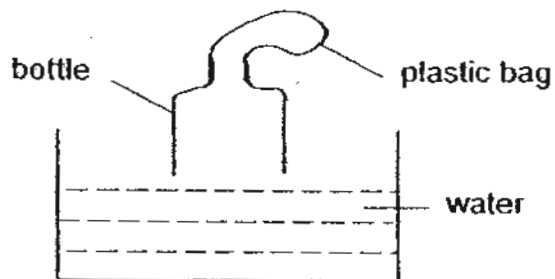

- a) What should Kelly do to inflate the plastic bag? (1m)

---

- b) Explain your answer in a). (2m)

---

---

43. Angeline sets up the following experiment, with 3 pieces of cardboard A, B and C, in a brightly- lit room.

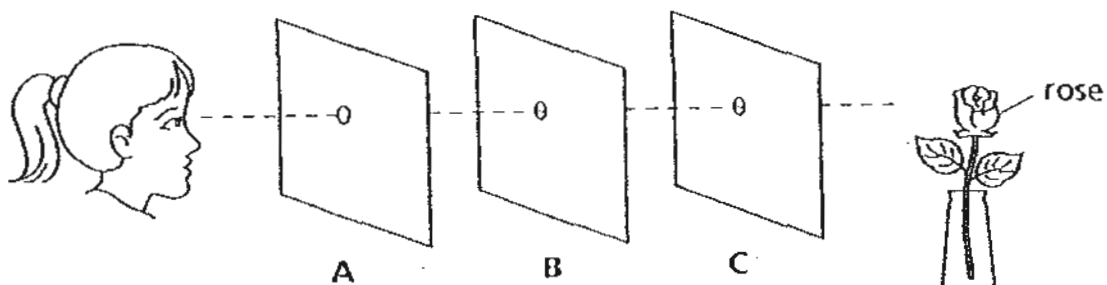

- a) Based on the diagram above, what would Angeline see if she looked through the hole in cardboard A? (1m)

---

- b) What would happen if cardboard B was shifted slightly to the right while Angeline was looking through the hole in cardboard A? (1m)

---

- c) Explain your answer for (b). (1m)

---

---

Next, Angeline placed the rose in a black box with no light source. She was not able to see the rose through the hole.

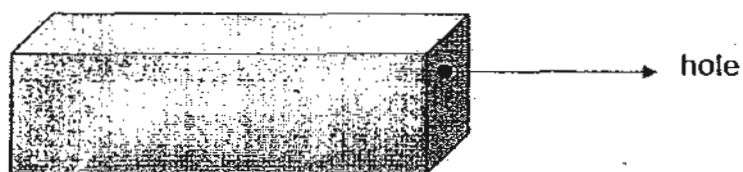

- d) Why was she not able to see the rose in the black box through the hole? (1m)

---

---

44. Nathalie was trying to see the cherry in a brightly lit room, using the set up as shown below.

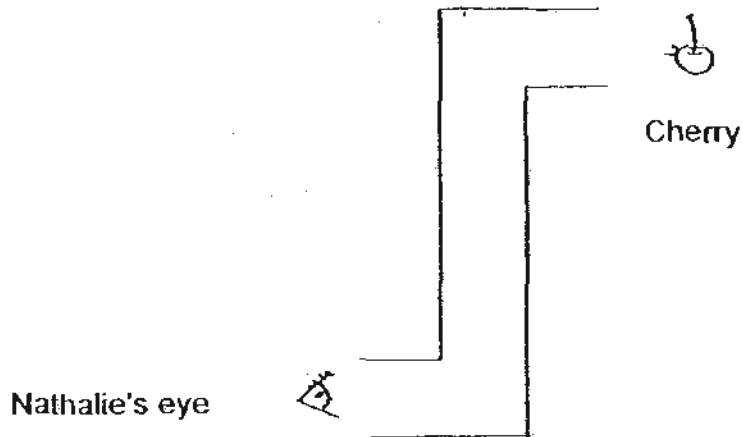

- a) Draw the mirrors in the set-up above, which will help Nathalie to see the cherry. (1m)
- b) Show the path of light by drawing the arrows in the set-up above. (1m)

End of Paper

# **ANSWER SHEET**

**EXAM PAPER 2010**

**SCHOOL : ROSYTH PRIMARY  
SUBJECT : PRIMARY 4 SCIENCE**

**TERM : SA1**

Q1	Q2	Q3	Q4	Q5	Q6	Q7	Q8	Q9	Q10	Q11	Q12	Q13	Q14	Q15	Q16	Q17
4	4	1	4	3	4	3	2	3	2	4	3	1	4	4	2	2

Q18	Q19	Q20	Q21	Q22	Q23	Q24	Q25	Q26	Q27	Q28	Q29	Q30
2	3	3	2	1	2	4	3	4	4	3	1	3

31) Both Plants B and C lives in water.

- 32) A: Insect  
B: Fish  
C: Mammal  
D: Bird

33a) They make their own food.

33b) A is a flowering plant while B is a non-flowering plant.

34a) Animal X lays eggs and it is an animal eater.

34b) Fox. It is not a plant eater but rather an animal eater.

34c)

Lay Eggs		Gives Birth	
Plant-eaters	Animal-eaters	Plant-eaters	Animal-eaters
-Grasshopper -Bee	-Alligator -Snake -X	-Goat	-Fox -Tiger -Wolf

35a) Adult Stage. It spread diseases.

35b) Dick. The mosquitoes will not have a place to lay eggs. There will be no breeding place.

36a) The life cycle of a chicken has 3 stages but the life cycle of a beetle has 4 stages.

36b) They both start from an egg.

36c) Group P: three-stage life cycle  
Group Q: four-stage life cycle

37a) The seedling used up the food in the seed leaves as it grows.

37b) Leaves.

38a) Set-up E. It has water, warmth and air which are required for germination to take place, while set-up F does not have water.

38b)

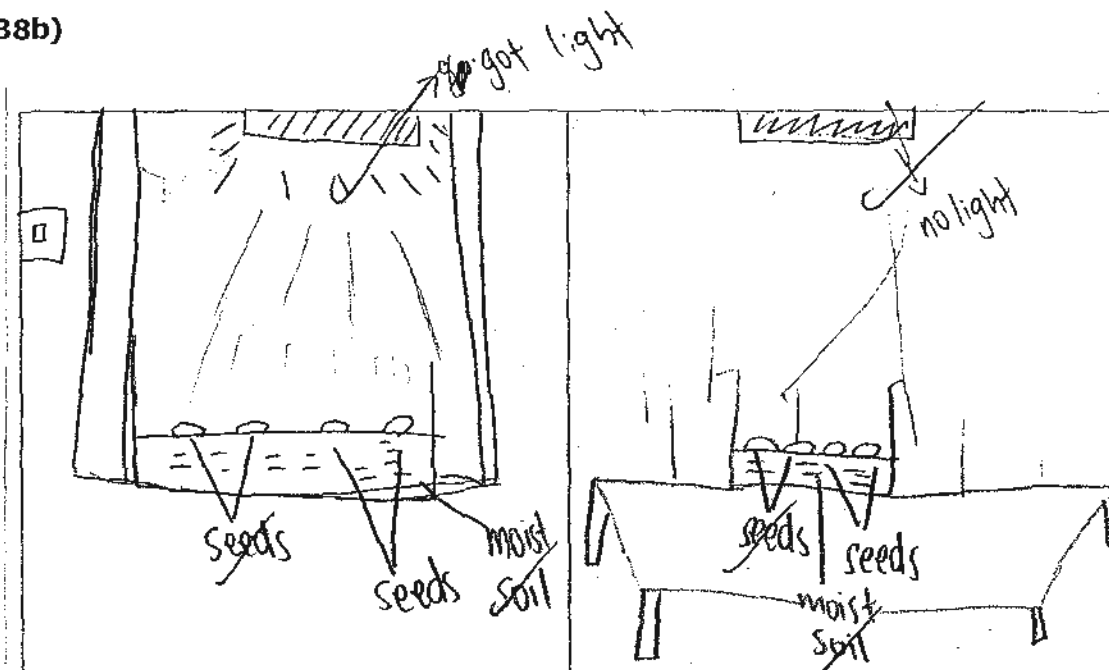

39a)  $150\text{cm}^3$

39b) 350 ml

40a) The water level will rise.

40b) Air occupies space. When air is sucked out of the cup, water will enter and occupy the space previously occupied by the air.

41a) R, S, P, Q (in sequence)

41b) They are made of different materials.

42a) Push the bottle into the water.

42b) Air occupies space. When water enters the bottle, air is being pushed into the plastic bottle, causing the bag to be inflated.

43a) Angeline will see the rose.

43b) Angeline would not be able to look at the rose.

43c) As light travels in a straight line, the light will not be able to reach her eyes as the path of light is blocked.

43d) The rose is not able to give out its own light.

44)

