

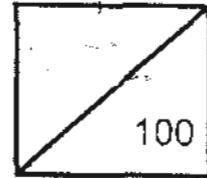

Rosyth School
First Semestral Assessment for 2010
STANDARD SCIENCE
Primary 5



Name: _____

Total
Marks:

Class: Pr _____

Register No. _____

Duration: 1 h 45 min

Date: 13th May 2010

Parent's Signature: _____

BOOKLET A

Instructions to Pupils:

1. Do not open the booklets until you are told to do so.
2. Follow all instructions carefully.
3. This paper consists of 2 booklets, Booklet A and Booklet B.
4. For questions 1 to 30 in Booklet A, shade the correct ovals on the Optical Answer Sheet (OAS) provided using a 2B pencil.
5. For questions 31 to 46, give your answers in the spaces given in the Booklet B.

	Maximum	Marks Obtained
Booklet A	60 marks	
Booklet B	40 marks	
Total	100 marks	

* This booklet consists of 19 pages.

This paper is not to be reproduced in part or whole without the permission of the Principal.

5044

- 8 Peter removed a ring of food-carrying tubes from a plant. He cut off a portion of the stem of a plant as shown below.

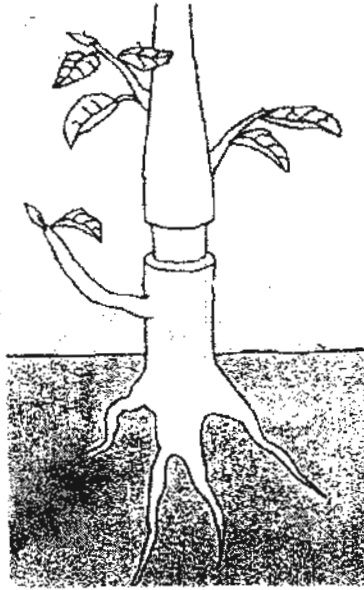

Which of the following will he observe after one week?

(1)

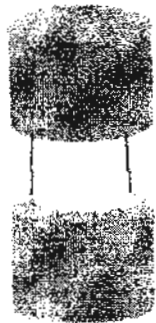

(2)

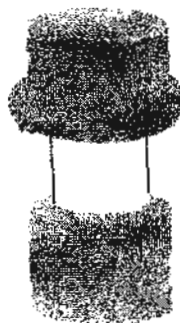

(3)

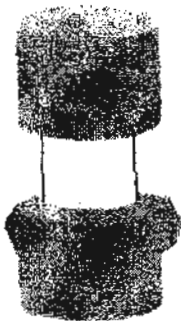

(4)



- 9 June cut a stalk of a white flower into half lengthwise with a penknife. She put one half of the stalk in a beaker of blue-coloured water and the other half in a beaker of red-coloured water as shown in the diagram below.

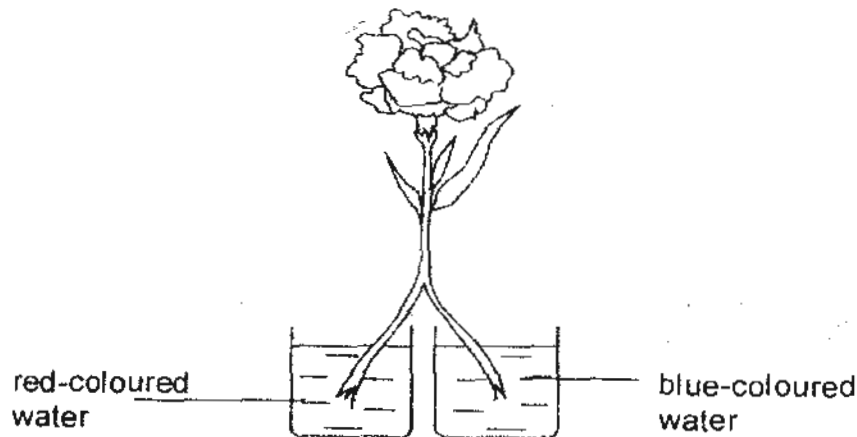

She left the stalk overnight. The next morning, one half of the flower became blue and the other half became red.

What can she conclude from the above experiment?

- (1) There is only one tube that transports water.
 - (2) There is more than one tube to transport water.
 - (3) Cutting the stalk into half increased the rate of transport of water.
 - (4) Cutting the stalk into half caused the food-carrying tube to carry water too.
- 10 Which of the following do the water-carrying tubes of a plant transport?
- A: water
 - B: food
 - C: oxygen
 - D: carbon dioxide
 - E: mineral salts
- (1) A and C only
 - (2) A and E only
 - (3) A, B and E only
 - (4) A, B, C and D only

11. Which one of the following diagrams best shows the path of the blood as it circulates?

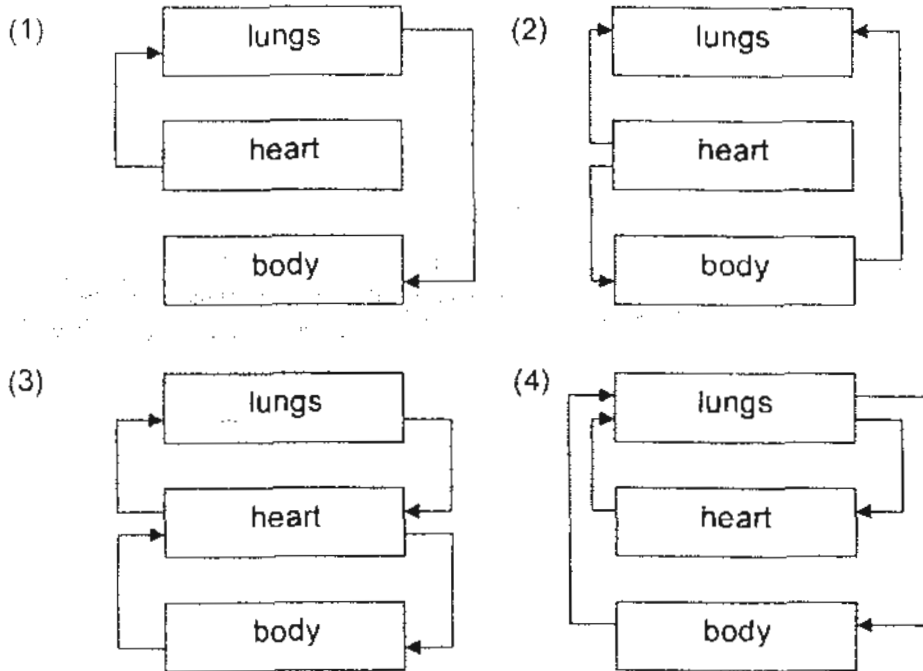

12. The diagram below shows how water travels in the circulatory system of a fish.

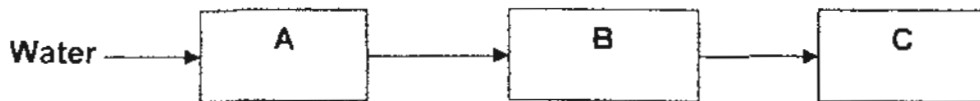

What can A, B, and C be?

	A	B	C
(1)	mouth	gills	mouth
(2)	nostril	gills	gill cover
(3)	mouth	gills	gill cover
(4)	nostril	gills	different parts of body

13 Study the diagram below.

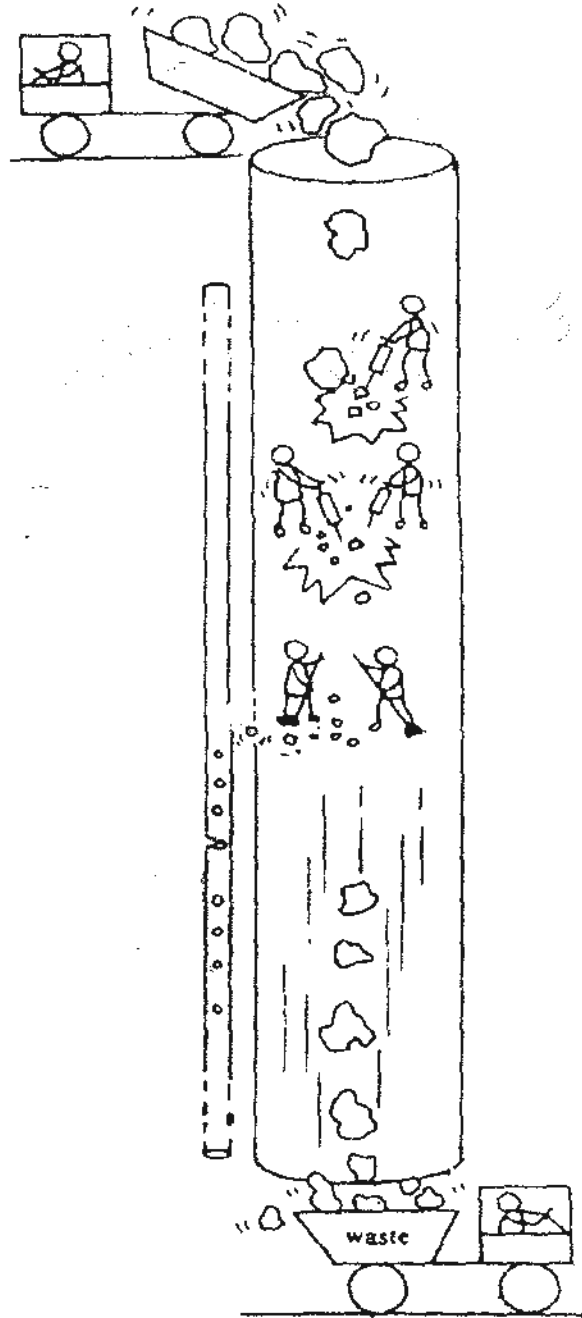

Which system undergoes a similar process?

- (1) human digestive system
- (2) plant transport system
- (3) human circulatory system
- (4) human respiratory system

14 When a boy was playing a basketball game, which of the following body systems were involved ?

- A: Skeletal System
- B: Muscular System
- C: Digestive System
- D: Circulatory System
- E: Respiratory System

- (1) A and B only
- (2) B , D and E only
- (3) C,D and E only
- (4) A, B ,C , D and E

15 The flowchart below shows how some animals are classified.

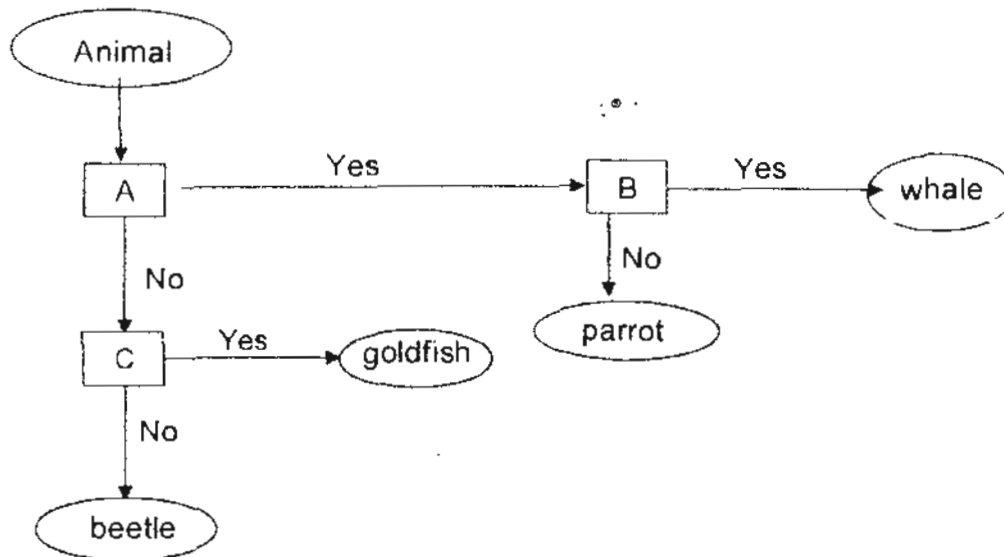

Which of the following are suitable questions that show the characteristics of Animals A, B and C in the flowchart above?

	A	B	C
(1)	Does it have gills?	Does it have lungs?	Does it live on land?
(2)	Does it live in water?	Does it have lungs?	Does it have gills?
(3)	Does it live on land?	Does it have gills?	Does it have lungs?
(4)	Does it have lungs?	Does it live in the water?	Does it have gills?

16 The diagram below represents the composition of gases taken in by man.

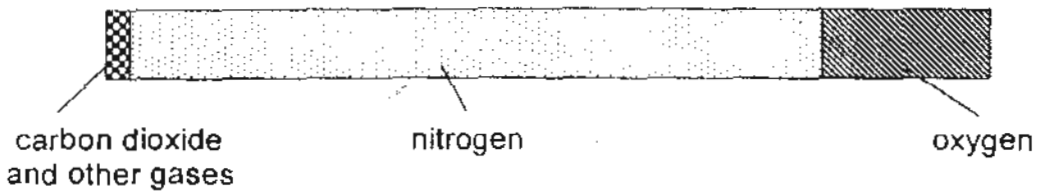

Which of the following statement(s) is/are true when air is given out by man?

- A: Amount of oxygen is reduced to zero
- B: Amount of carbon dioxide has increased
- C: Amount of nitrogen is more than before

- (1) A only
- (2) B only
- (3) A and C only
- (4) B and C only

17 The leaf is often referred to as a 'food factory' as its function is to make food for the plant. The leaf below is carrying out this function.

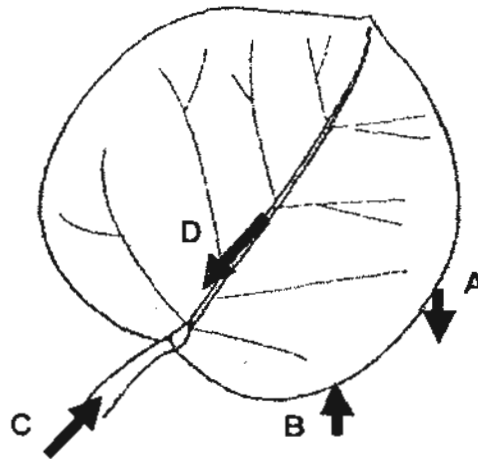

Which of the following shows the correct set of labels for the arrows?

	A	B	C	D
(1)	carbon dioxide	sunlight	food	water
(2)	food	water	sunlight	oxygen
(3)	water	oxygen	carbon dioxide	sunlight
(4)	oxygen	carbon dioxide	water	food

- 18 Some grasshoppers and burning candles are placed in 4 similar bell jars as shown in the diagram below.

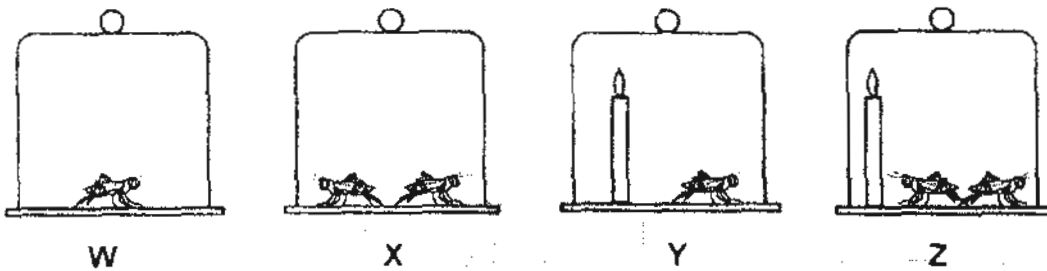

Which one of the bell jars will have the least amount of oxygen after a period of time?

- (1) W (2) X
 (3) Y (4) Z

- 19 The diagram below shows an electric circuit.

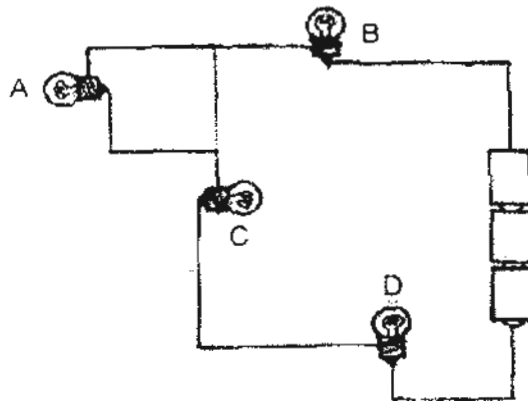

With all the components unchanged, which bulb should be removed so that the rest of the bulbs remain lit?

- (1) A (2) B
 (3) C (4) D

20 Which of the following set-ups would be the brightest?

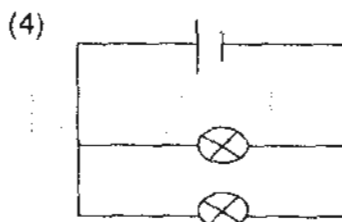
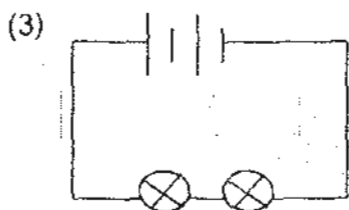
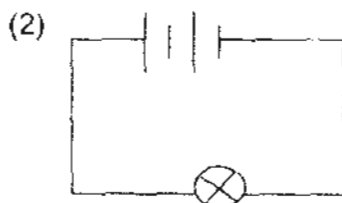
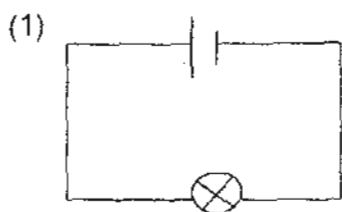

21 The diagram below shows an electric circuit. When the object, X, was added into the circuit, the bulb became brighter.



Which one of the following can be deduced from the above observation?

- (1) X is a wire.
- (2) X is a bulb.
- (3) X is a source of electricity.
- (4) X is a better conductor of electricity.

22 The circuits below are set up with different materials, R, S, T and U.

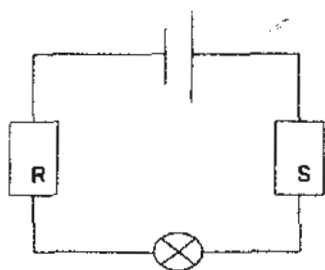

Set-up A

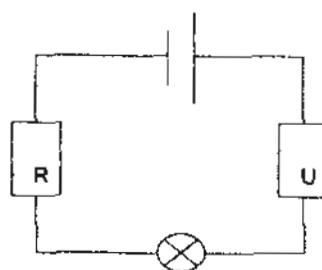

Set-up B

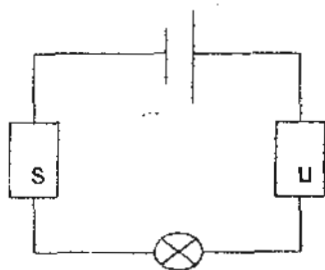

Set-up C

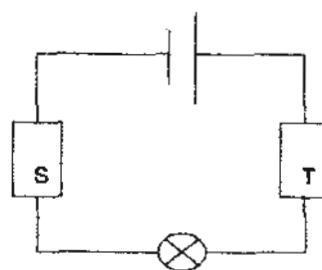

Set-up D

The results of the experiment are shown in a table below.

Setup	Lights Up	Does not light up
A	✓	
B		✓
C		✓
D	✓	

Which of the materials R, S, ~~X~~ and U is/are insulators of electricity?

- (1) U only
- (2) R and U only
- (3) S and U only
- (4) R, S and U only

23 Viknesh wanted to find out if the number of batteries will affect the amount of electrical energy in a circuit.

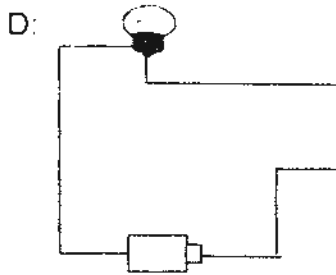
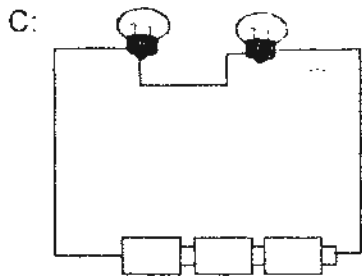
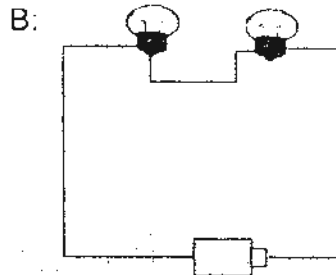
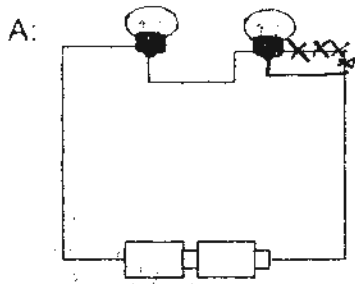

Which set-ups should he use for a fair experiment?

- (1) A and D only
- (2) A, B and C only
- (3) B, C and D only
- (4) A, B, C and D

25 Ishak was given the following objects A to F as shown below.

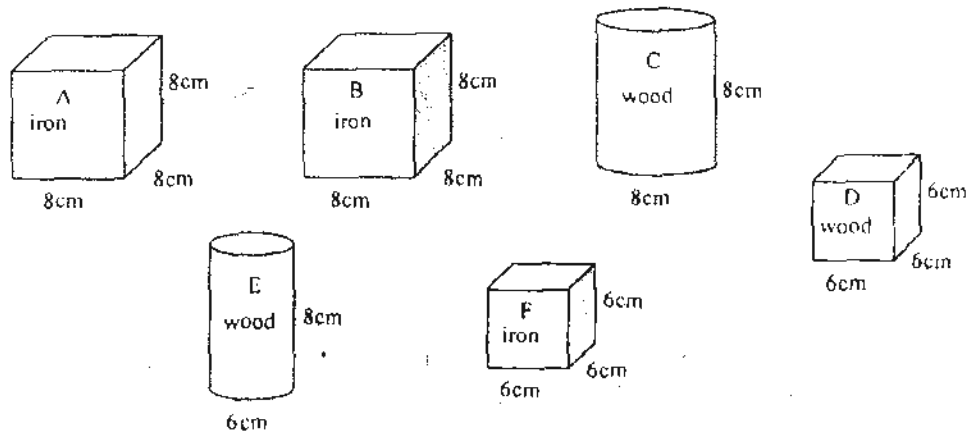

He chose objects D and F only to carry out an investigation.
What could be the possible aim of his investigation?

- (1) To find out if the materials of an object will affect the mass of the object
- (2) To find out if the materials of an object will affect the volume of the object
- (3) To find out if the volume of an object will affect the mass of the object
- (4) To find out if the mass of an object will affect the volume of the object

26 Which of the following properties should you investigate in order to classify the objects according to the states of a matter?

- A: Find out if the objects have mass
- B: Find out if the objects have volume
- C: Find out if the objects have definite shape
- D: Find out if the objects can be compressed

- (1) A and B only
- (3) B and C only

- (2) A and D only
- (4) C and D only

- 27 Gopal filled a 200 cm^3 measuring cylinder with water. He filled up another 200 cm^3 measuring cylinder with some pebbles. Next, he transferred both the water and pebbles into a 500 cm^3 measuring cylinder.

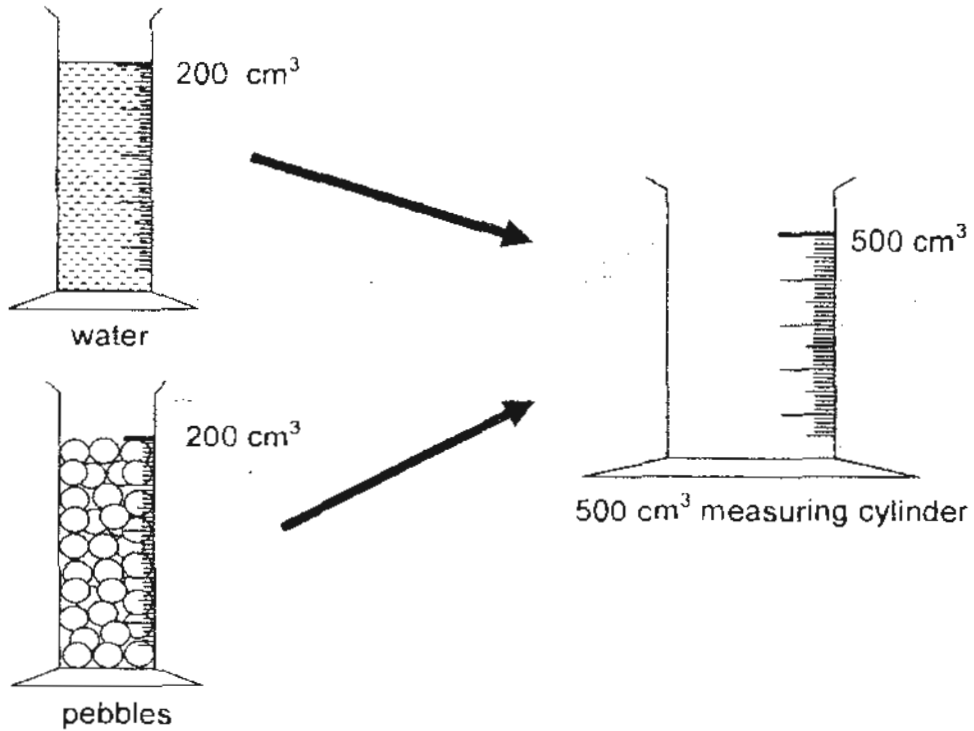

Which one of the following diagrams shows the possible volume occupied by the water and the pebbles in the 500 cm^3 measuring cylinder?

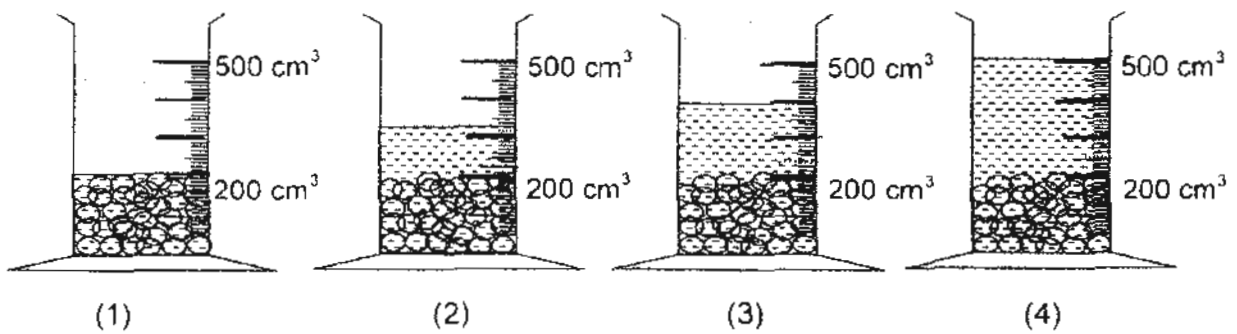

28 The four pans shown below are of the same size.

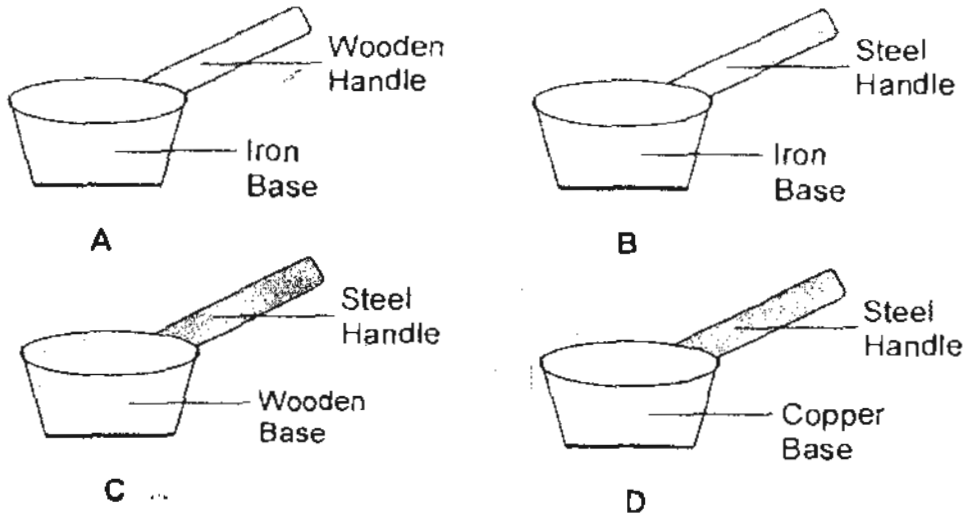

Which two pans can be used to show that steel is a good conductor of heat?

- (1) A and B
- (2) A and C
- (3) B and C
- (4) C and D

29 Simon filled four cups made of different materials with hot water.

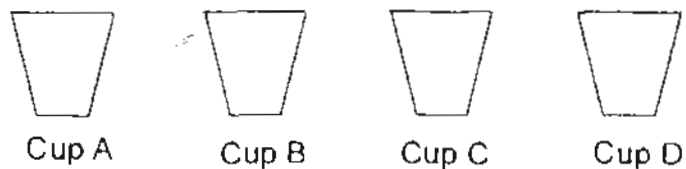

He measured the time taken for the water to reach the room temperature. The result was as shown in the graph below.

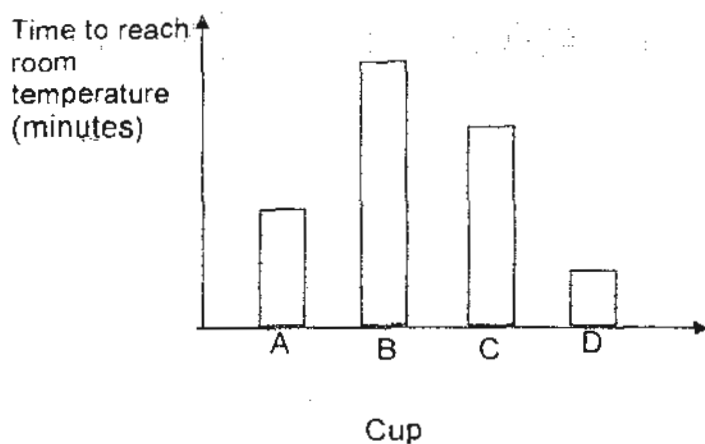

Which one of the following cups is the best conductor of heat?

- (1) A
- (2) B
- (3) C
- (4) D



Rosyth School
First Semestral Examination for 2010
STANDARD SCIENCE
Primary 5

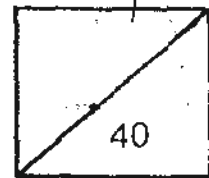

Total
Marks:

Name: _____

Class: Pr _____ Register No. _____ Duration: 1 h 45 min

Date: 13 May 2010

Parent's Signature: _____

BOOKLET B

Instructions to Pupils:

1. For questions 31 to 46, give your answers in the spaces given in this Booklet B.

* This booklet consists of 15 pages.

This paper is not to be reproduced in part or whole without the permission of the Principal.

Part II (40 marks)

For questions 31 to 46, write your answers in this booklet. The number of marks available is shown in brackets [] at the end of each question or part question.

31 Lily found an image of a single-celled organism from the Internet.

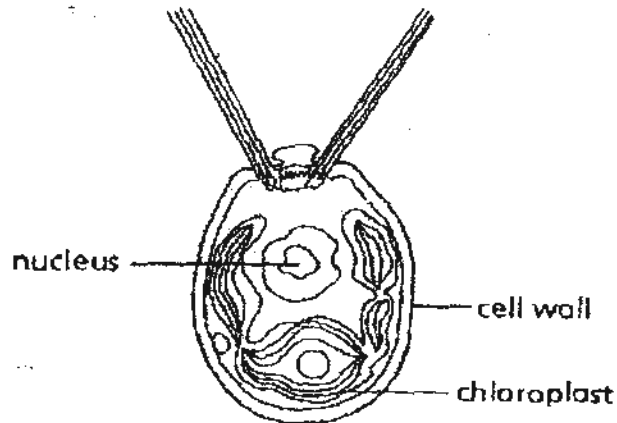

(a) Is the organism an animal cell or a plant cell? Give reasons to support your choice. [1]

(b) What is the function of the chloroplasts of the organism? [1]

32 The diagrams below show two animal cells.

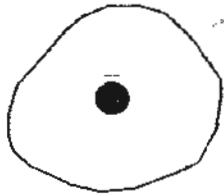

Cheek Cell

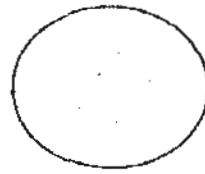

Red Blood Cell

Both the cells have cell membrane but the cheek cell has a nucleus while the red blood cell does not have a nucleus.

- (a) Which cell (cheek cells or red blood cells) can divide to form new cells? Explain your answer. [1]

- (b) Why do cells in multi-cellular organisms need to divide? [1]

- 33 Michael used a bag made of a special material to contain some red dye solution. He placed the bag in a beaker of pure water.

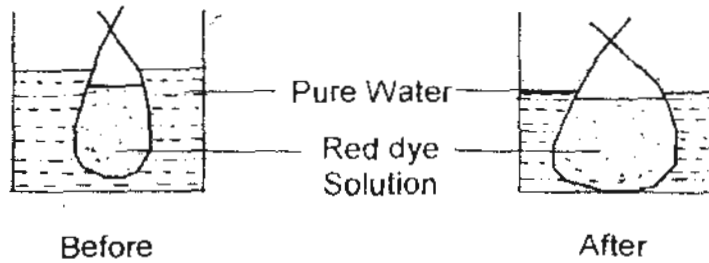

He made the following observations. The bag became bigger and the pure water in the beaker was not mixed with any red dye solution.

- (a) What has caused the bag to become bigger? [1]

- (b) Which part of a cell has a similar function as the bag? [1]

- 34 Claire wanted to find out the volume of water taken in by a plant. She prepared the two set-ups as shown below.

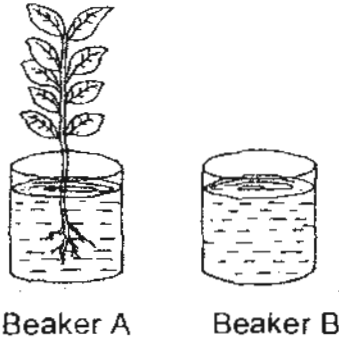

Beakers A and B were left in the open for a week. The table below shows the volume of water in A and B on Day 1 and Day 7 of the experiment.

Beaker	Volume of water (ml)	
	Day 1	Day 7
A	1000	850
B	1000	950

- (a) What was the volume of water taken in by the plant? [1]

- (b) If Claire did not set up beaker B for her experiment, what could she do to find out the volume of water taken in by the plant? [1]

Claire's classmate, Pete, prepared the 2 set-ups shown below. He left the beakers in the open for a week.

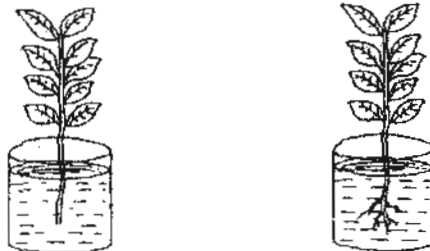

- (c) State the aim of Pete's experiment. [1]

35 Suresh compared the plant and human circulatory system.

(a) State a similarity between the plant transport system and the human circulatory system. [1]

(b) State a difference between the plant transport system and the human circulatory system. [1]

36 Shandy plucked some leaves and placed them into a beaker of hot water. She observed bubbles.

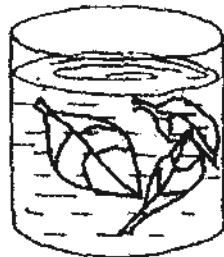

(a) State the difference she would observe between the upper and lower surfaces of the leaves. [1]

(b) Give a reason for the observation in (a). [1]

- 37 A man ran on a treadmill at different speeds. His average pulse rate was measured at different speeds. The results were shown in the table below.

X	Y
0	72
4	80
6	96
8	112
10	120

- (a) Write suitable headings for X and Y in the blanks below. [2]

X: _____ Y: _____

- (b) Why did the man's pulse rate increase when he ran faster on the treadmill? [1]

- (c) What effect will running on the treadmill have on his breathing rate? [1]

38 The mass rapid transit (MRT) is a system with many parts working together like the human circulatory system. Ah Seng compared the mass rapid transit system to the human circulatory system to make analogies.

(a) Which part of the circulatory system can be represented by the tracks of the mass rapid transit (MRT) system? Give a reason for your choice. [1]

(b) The engine of the mass rapid transit (MRT) system provides the pushing force for the train to move. Which part of the human circulatory system has a similar function? Describe the part's function. [2]

- 39 Study the apparatus shown in the diagram below. The apparatus is used as a model to show the human respiratory system.

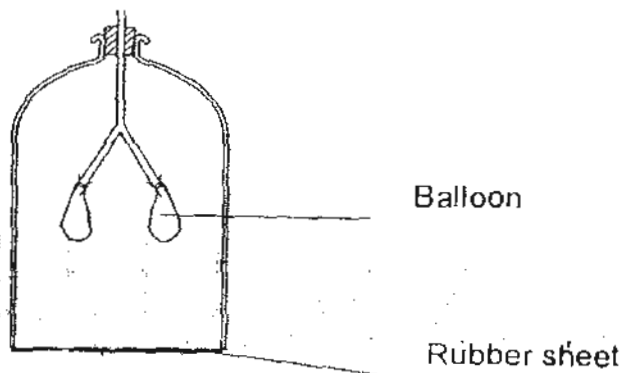

- (a) Which parts of the respiratory system do the balloons represent? [1]
-

Meili wanted to pull the rubber sheet down as shown in the diagram below.

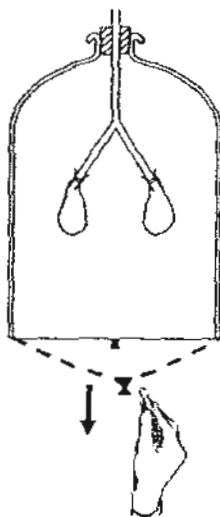

- (b) What would happen if the rubber sheet is pulled down? [1]
-

- (c) Explain why pulling down the rubber sheet causes this to happen. [1]
-
-

- 40 Ruben had studied the function of the human digestive system is to digest the food into simple substances. He drew a graph to show the amount of undigested food in the food we consume as it moves from the mouth to the large intestine as shown below.

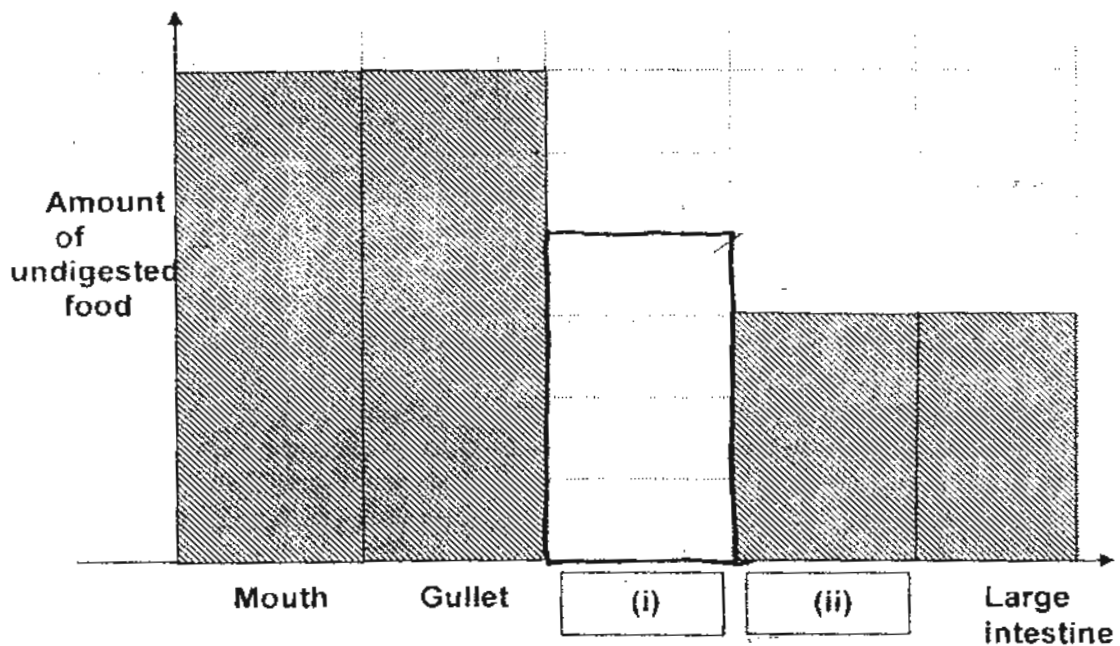

- (a) Fill in the blanks to name the unlabelled parts of the digestive system. [2]
 Part (i) : _____ Part (ii) : _____
- (b) Complete the bar graph above to show the amount of undigested food at Part (i) [1]

- 41 Jasmine set up an electric circuit as shown below. The three objects (E, F and G) were made of different materials. She noticed when she turned on two switches at a time, only some bulbs lighted up.

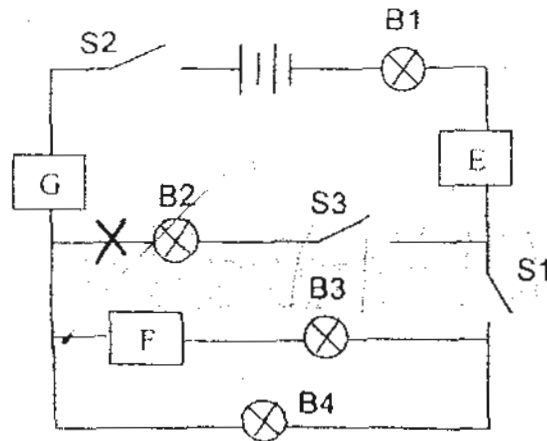

The results were recorded in the table below.

Switches turned on	Bulbs lighted up
S1, S2	B1, B4
S2, S3	B1, B2

- (a) Which object(s) ~~is~~ are conductors of electricity? [1]
-
- (b) Jasmine wanted to place a buzzer in the circuit so that when she closes the switches, S2 and S3, the buzzer will ring. Mark an 'X' in the diagram above to show where she should place the buzzer. [1]
-

- 42 Jake carried out an experiment with a closed circuit. The batteries were added one at a time. He plotted the results on a graph as shown below.

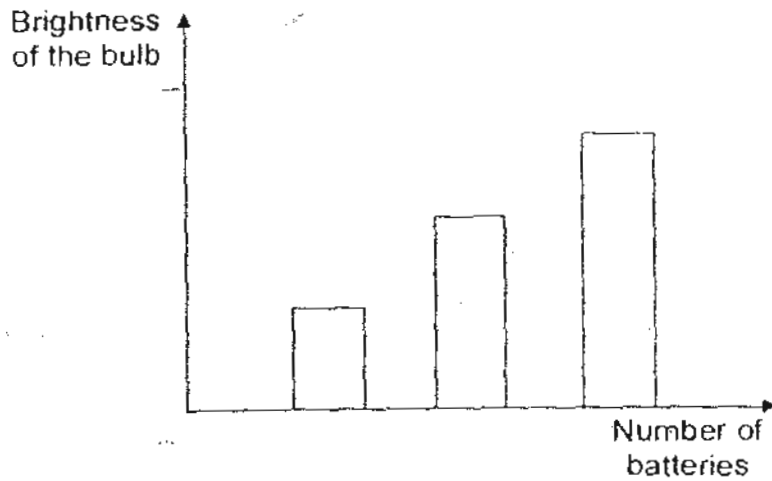

- (a) What was the Jake trying to find out from the experiment? [1]

- (b) Jake added another battery to the experiment and the bulb did not light up. What has happened to the bulb? [1]

43 Look at the set-up below carefully.

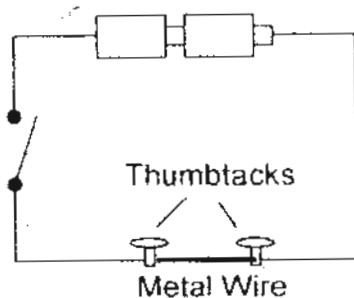

(a) What happens to the metal wire when the switch is closed? [1]

(b) What is the function of the switch in the set-up? [1]

44 Lisa is trying to find out if the arrangement of bulbs will affect the brightness of the bulb.

(a) Using the materials provided, draw two circuit diagrams to show how her experiment should be conducted. [2]

- Four light bulbs
- Some wires
- 2 batteries

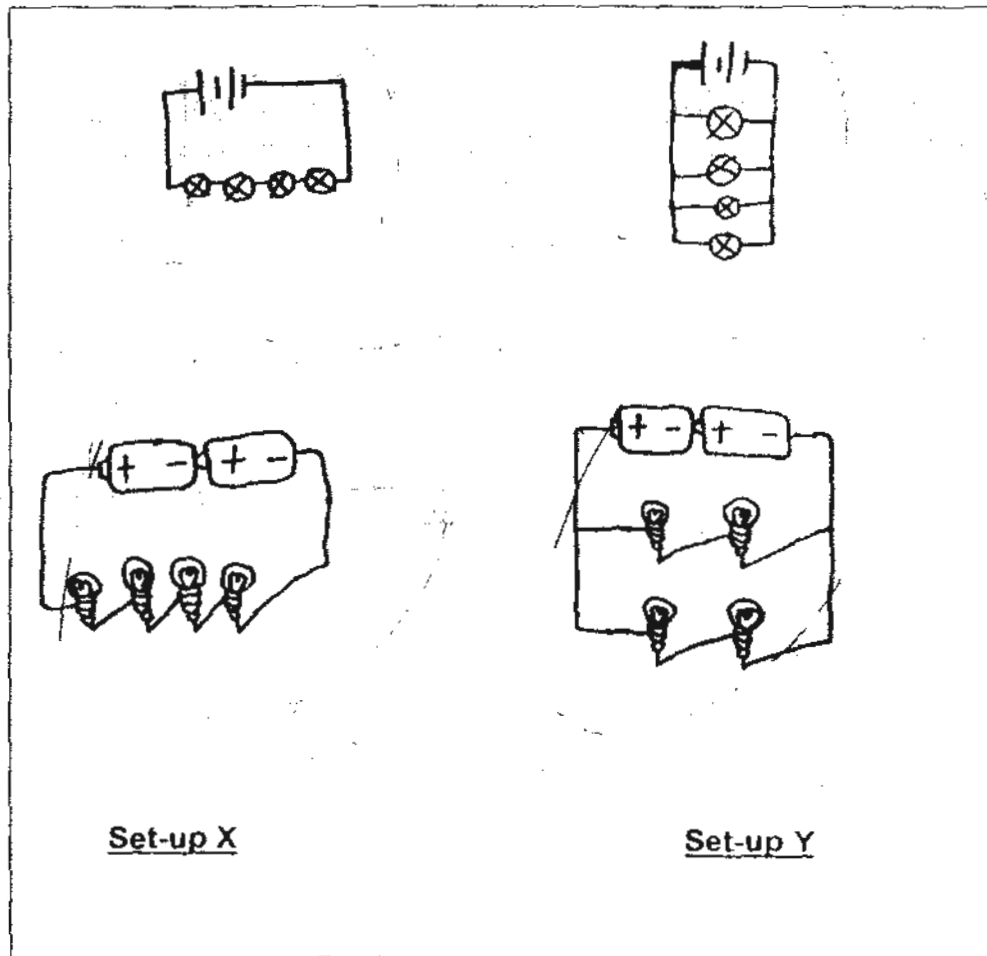

(b) Why does Lisa need to keep the number of batteries the same in the experiment? [1]

- 45 The diagram below shows a pump connected to a glass jar of capacity 400 cm^3 . The glass jar contains air.

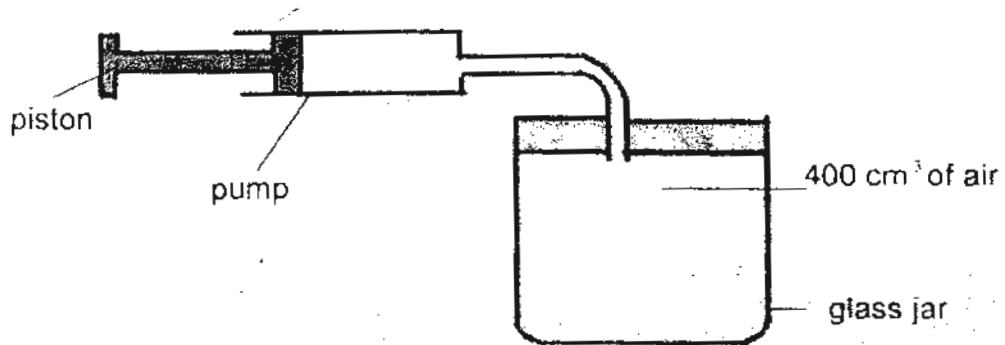

- (a) When the piston is pushed in completely into the pump, 30 cm^3 of air is forced into the glass jar. What is the volume of the air in the glass jar now? Explain your answer [1]

The set-up above is filled with water as shown in the diagram below.

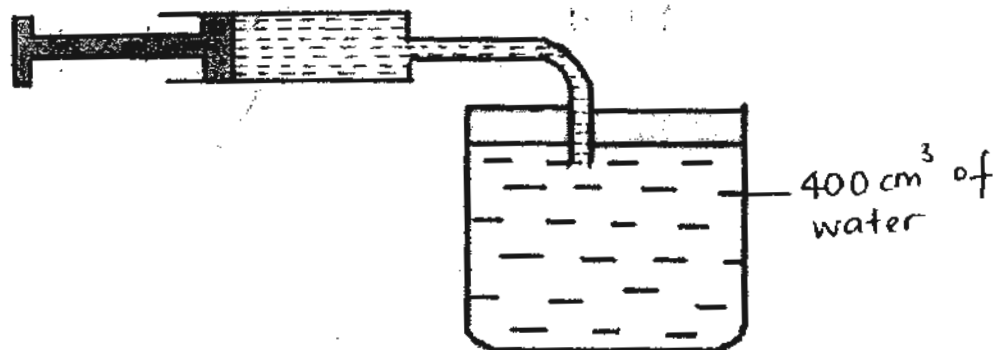

- (b) What will happen when the piston of the pump is pushed? [1]

- 46 Jason placed two beakers of boiling water into two boxes made of different materials. He measured the temperature of the water over a period of time.

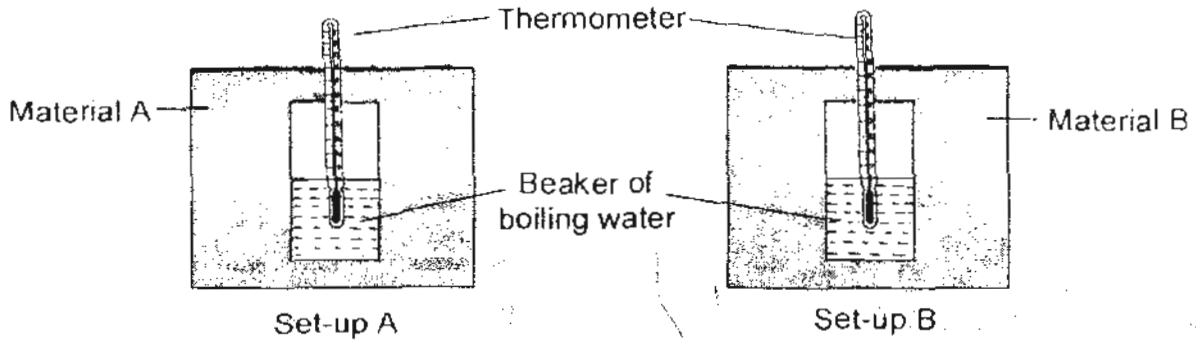

Jason recorded the results of the experiment and plotted them onto a graph as shown below. It shows the change in temperature of water in both set-ups.

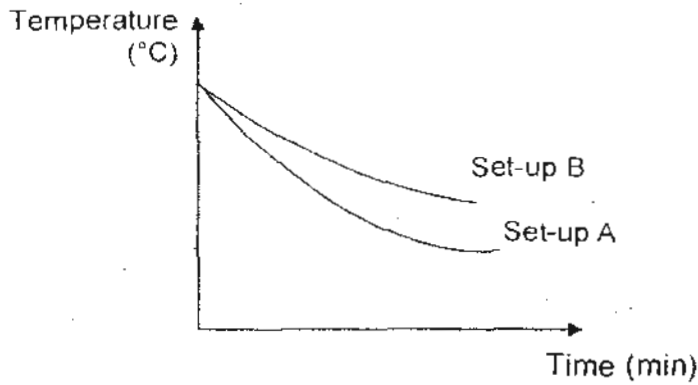

- (a) What was Jason trying to find out from the experiment? [1]

- (b) Explain why the temperature in both set-ups decrease. [1]

- (c) Name two variables that must be kept the same in the above experiment.

End of Paper

ANSWER SHEET

EXAM PAPER 2010

SCHOOL : ROSYTH PRIMARY
SUBJECT : PRIMARY 5 SCIENCE

TERM : SA1

Q1	Q2	Q3	Q4	Q5	Q6	Q7	Q8	Q9	Q10	Q11	Q12	Q13	Q14	Q15	Q16	Q17
2	3	3	2	4	2	1	2	2	2	3	3	1	4	4	2	4

Q18	Q19	Q20	Q21	Q22	Q23	Q24	Q25	Q26	Q27	Q28	Q29	Q30
4	1	2	3	1	2	1	1	4	2	1	4	4

31)a)The organism is a plant cell. It has a cell wall and chloroplasts, which animal cells do not have.

b)They contain chlorophyll which traps sunlight for the organism to make food.

32)a)Cheek cells can divide to form new cells. The nucleus in the cheek cell stores genetic information which will be passed down to the daughter cells but the red blood cell does not have a nucleus so it cannot divide.

b)They divide to replace old and damaged cells, for growth and reproduction.

33)a)The pure water entered the bag.

b)Cell membrane.

34)a)100ml

b)She could put a layer of oil on the water surface in beaker A.

c)The aim is to find out whether the presence of roots affect the amount of water taken in by the plant.

35)a)Both have tubes which transport food and water around the plant or human.

b)The plant transport system has tubes which transport only food, water and nutrients while the human circulatory system has tubes that transport digested food, water, oxygen, carbon dioxide and waste materials.

36)a) There would be less bubbles or no bubbles on the upper surface of the leaves but there would be more bubbles on the lower surface of the leaves.

b) Most of the stomata is found on the lower surface of leaves, so when the leaves respire in the hot water Shandy would observe more bubbles on the lower surface of the leaves than on the upper surface.

37)a) X: Speed of treadmill Y: Pulse rate

b) The pulse rate increases as the heart pumps faster to supply more oxygen and digested food to the muscles and the rest of the body to produce more energy.

c) His breathing rate would increase.

38)a) The blood vessels. It transports blood/food/water/oxygen from one part of the body to another.

b) The heart. The heart pumps the blood to all parts of the body, just as the mass rapid transit (MRT) circulates around Singapore.

39)a) The lungs.

b) The balloons would inflate.

c) Pulling the rubber sheet down increases the volume of space in the jar so air will rush into the balloons to fill up this extra space.

40)a) i) stomach ii) Small intestine.

b)

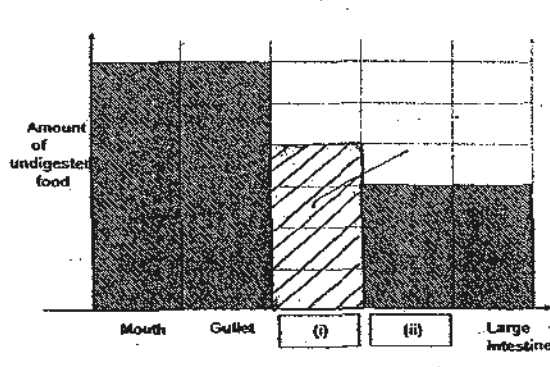

41)a) Objects E and G only.

b)

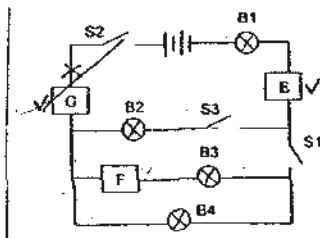

42)a) Jake was trying to find out if the number of batteries affects the brightness of the bulb.

b) The filament has melted.

43)a) It becomes hot/warm.

b) It is to control the flow of the electric current in the circuit.

44)a)

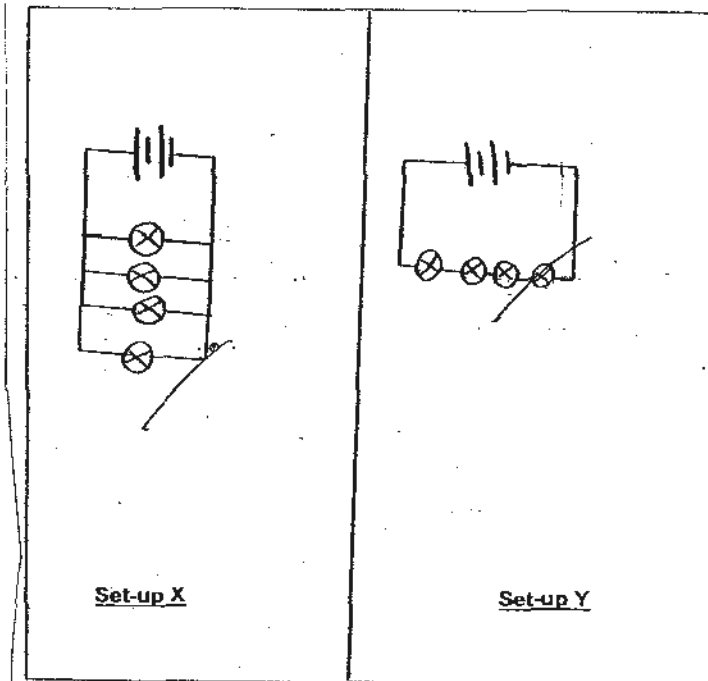

b) So that the number of batteries will not affect the brightness of the bulbs and cause the result to be inaccurate.

45)a) 400cm³. Air takes up the shape and volume of its container and it can be compressed.

b) The piston cannot be pushed in.

46)a) To find out which material is a better.

b) The heat of the water is lost to the surrounding air.

c) Thickness of material.