

Name: _____ ()

Class: Primary 5 _____

CHIJ ST NICHOLAS GIRLS' SCHOOL (Primary)



Primary 5 2010 First Semestral Assessment SCIENCE

BOOKLET A

12 May 2010

Total Time for Booklets A and B: 1 h 45 min

30 questions
60 marks

Do not open this booklet until you are told to do so.
Follow all instructions carefully.
Answer all questions.

Parent's Signature / Date

This paper consists of 21 printed pages.

Section A : (30 x 2 MARKS)

For each question from 1 to 30, four options are given. One of them is the correct answer. Make your choice (1, 2, 3 or 4). Shade the correct oval (1, 2, 3 or 4) on the Optical Answer Sheet.

1. The table below lists the parts of a cell. The ticks (✓) represent the parts of a cell that Cell X, Y and Z have.

Part of the cell	Cell X	Cell Y	Cell Z
Cytoplasm	✓	✓	✓
Cell membrane	✓	✓	✓
Cell wall		✓	✓
Nucleus		✓	✓
Chloroplast			✓

Based on the information above, which of the following statement(s) is/are correct?

- A X and Y are animal cells.
- B Z is the only cell that can make food.
- C Y and Z can control the movement of materials in and out of itself but X cannot.

- (1) B only
- (2) A and B only
- (3) A and C only
- (4) A, B and C

2. The diagram below shows a picture of a cell.

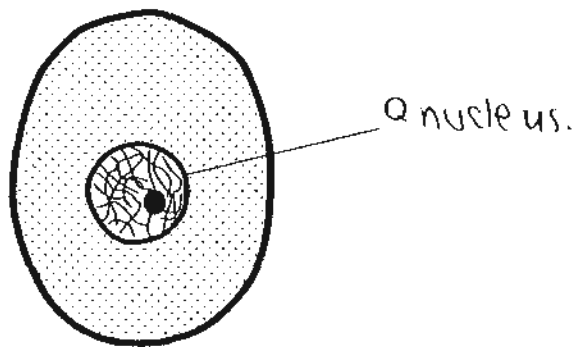

Part Q of the cell _____.

- (1) contains jelly-like substances
- (2) allows the cell to have its shape
- (3) allows certain materials to get in and out of the cell
- (4) contains materials that allow the young to look like its parents

3. The diagram below shows a microscope.

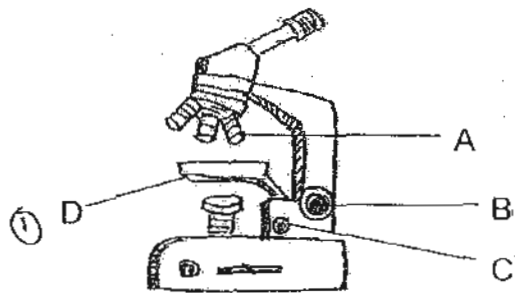

The statements below show the steps on how to observe a specimen under the microscope.

- Step 1: Place the specimen slide on it.
- Step 2: Turn the knob to raise or lower the stage.
- Step 3: Turn the objectives lens to magnify the specimen.
- Step 4: Turn the knob to view the specimen clearly.

Match the letters A, B, C and D to the steps above in order to observe the specimen clearly.

- (1) A, D, B, C
- (2) A, C, D, B
- (3) D, B, A, C
- (4) D, B, C, A

4. The table below shows the components of a particular microscope and its magnifying power:

Component	Magnifying Power
Eyepiece A	5 X
Eyepiece B	10 X
Objective Lens P	10 X
Objective Lens Q	40 X
Objective Lens R	100 X

Natasha was given a specimen which can only be viewed fully and clearly between magnifications of 100 X and 350 X.

Which one of the following set of eyepieces and objective lens should Natasha choose in order to view the entire specimen?

	Eyepiece	Objective Lens
(1)	A	P
(2)	A	Q
(3)	A	R
(4)	B	R

5. Study the flow chart carefully.

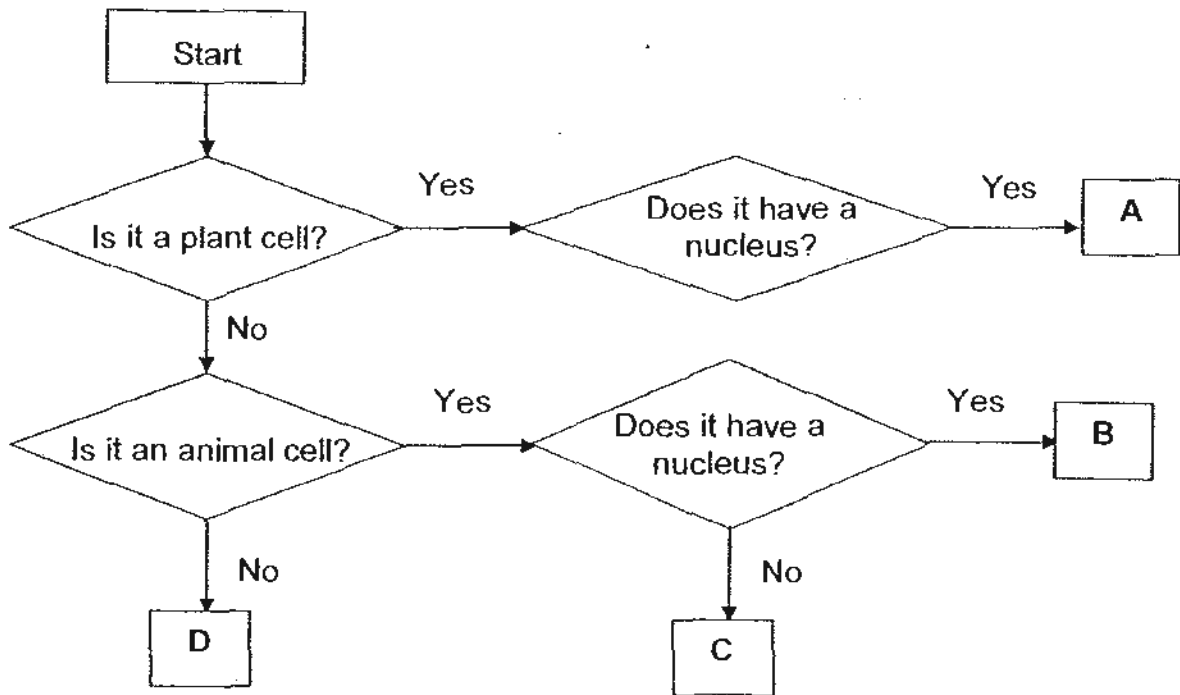

Which one of the following shows the correct organisms represented by the letters, A, B, C and D?

	A	B	C	D
(1)	Onion	White blood cell	Yeast	Red blood cell
(2)	Yeast	Red blood cell	White blood cell	Onion
(3)	Onion	White blood cell	Red blood cell	Yeast
(4)	Yeast	Onion	Red blood cell	White blood cell

6. Which one of the following shows the correct composition of gases when a person inhales and exhales?

(1)

	Inhale	Exhale
Oxygen	21%	17%
Carbon Dioxide	0.03%	4%
Nitrogen	78%	78%

(2)

	Inhale	Exhale
Oxygen	17%	21%
Carbon Dioxide	4%	0.03%
Nitrogen	78%	78%

(3)

	Inhale	Exhale
Oxygen	21%	17%
Carbon Dioxide	0.03%	4%
Nitrogen	78%	76%

(4)

	Inhale	Exhale
Oxygen	21%	21%
Carbon Dioxide	0.03%	4%
Nitrogen	78%	76%

7. The following graph shows the effect of the same intensity of exercise on the heart rate of a trained athlete and an untrained one. Study the graph carefully.

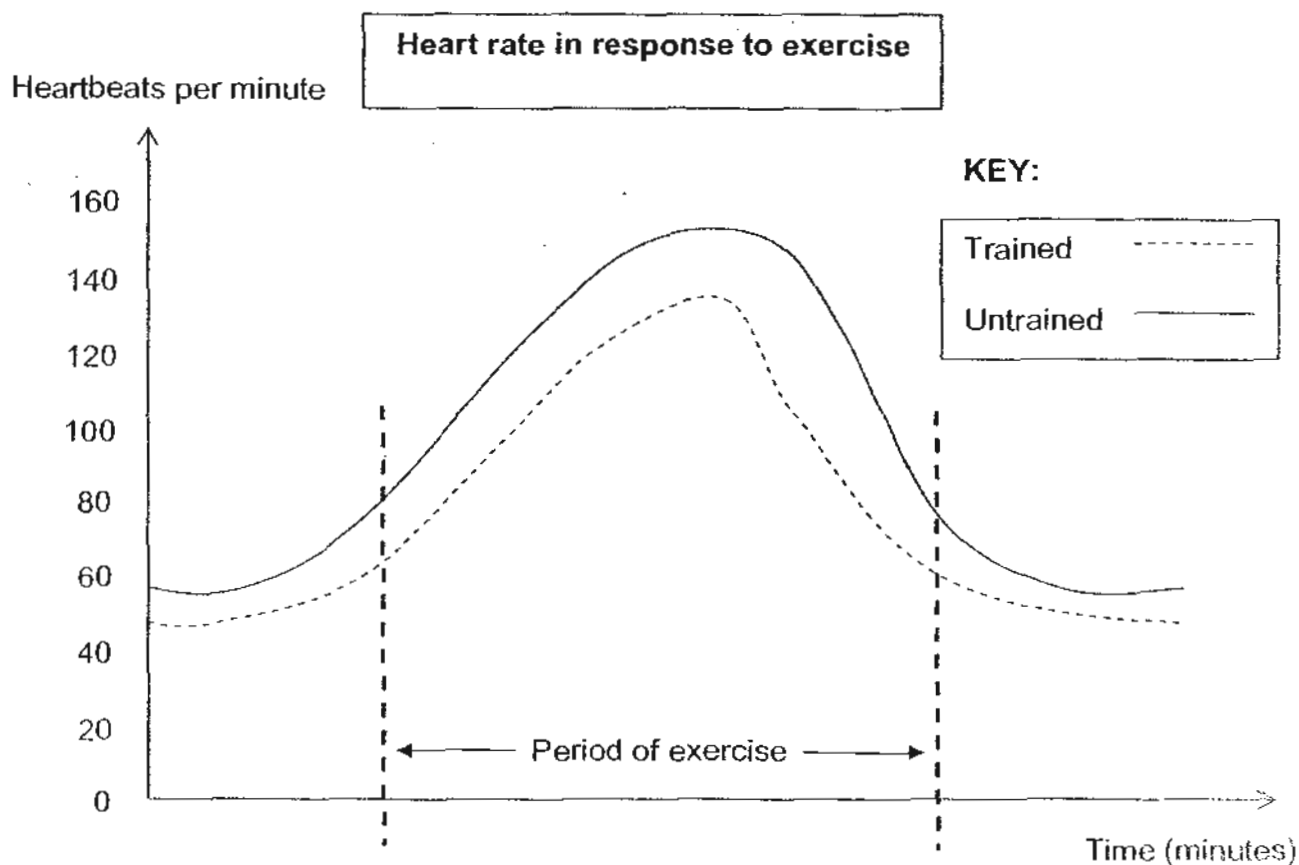

Based on the graph above, which one of the following statements is true?

- (1) The trained athlete is using less energy to complete the exercise.
- (2) The trained athlete is using more oxygen to complete the exercise.
- (3) The resting heart rate of an untrained athlete is lower than that of a trained athlete.
- (4) The resting heart rate of a trained athlete is lower than that of an untrained athlete.

8. The diagram below shows the floor plan of a room. A, B, C, D and E are mirrors. From where he is standing, Aaron needs only two mirrors to help him see the cupboard behind the wall.

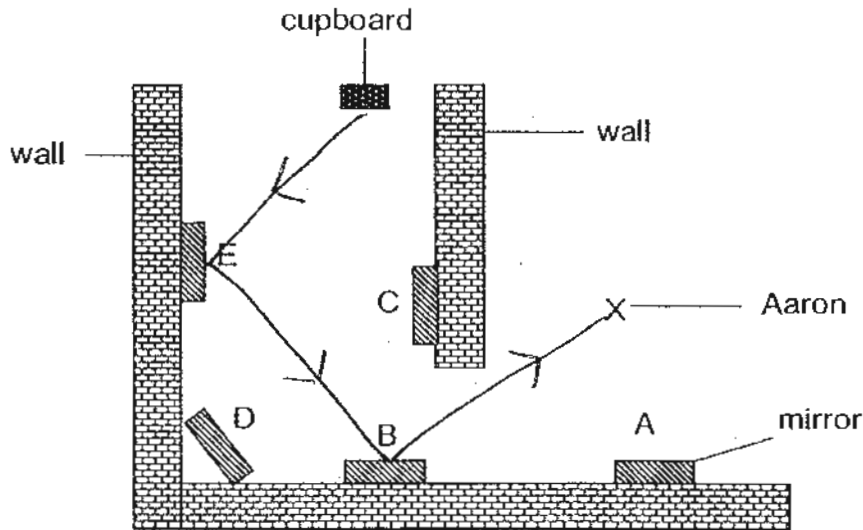

Which two mirrors will help him see the cupboard behind the wall?

- (1) A and C only
 - (2) B and C only
 - (3) B and E only
 - (4) C and D only
9. Amirah carried out an experiment to find out if (plants) take in water.

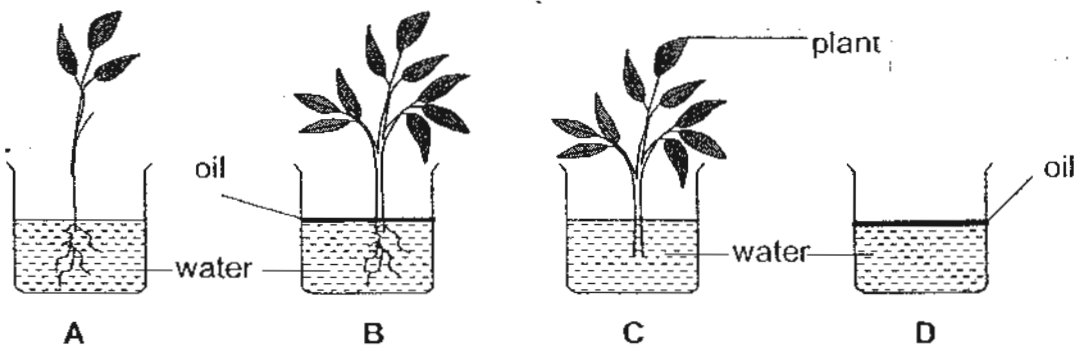

Which two set-ups shown above should she use in order to carry out a fair test?

- (1) A and B only
- (2) A and D only
- (3) B and C only
- (4) B and D only

10. Which one of the following shows what happens to the human chest, diaphragm and ribs when a person is coughing?

	Chest	Diaphragm	Ribs
(1)	Becomes bigger	Move upwards	Move outwards
(2)	Becomes bigger	Move downwards	Move outwards
(3)	Becomes smaller	Move upwards	Move inwards
(4)	Becomes smaller	Move downwards	Move inwards

11. The diagram below shows parts of the human respiratory system.

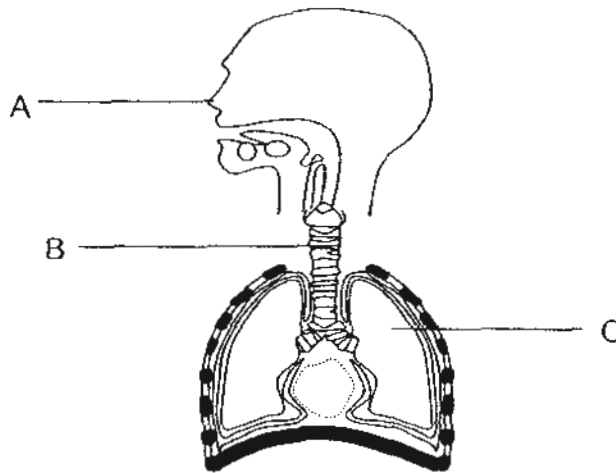

Based on the diagram above, which of the following statements are ~~true~~?

- A Part A allows air to enter and leave the body system.
 - B Part B is the main pipe that air enters and leaves.
 - C Part C contains tiny air sacs surrounded by many tiny blood vessels.
 - D Part B cleans the air by trapping impurities before the air enters the system.
- (1) A and B only
 (2) B and C only
 (3) C and D only
 (4) A, B and C only

12. A stalk of a celery plant, with a part cut out, is lowered into a beaker of coloured water as shown in the diagram below.

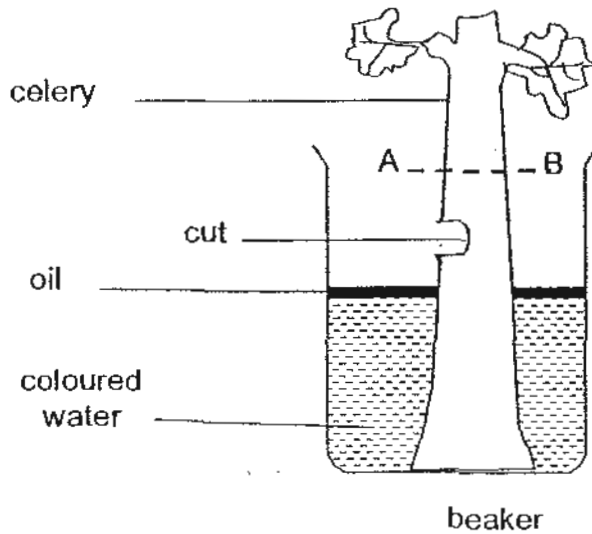

After two days, the stalk of celery in the beaker was cut at AB. The coloured water is indicated by the shaded portion(s) of the cut section of the celery. Which one of the following diagrams shows how the coloured water would be seen in the cross section of the celery stalk?

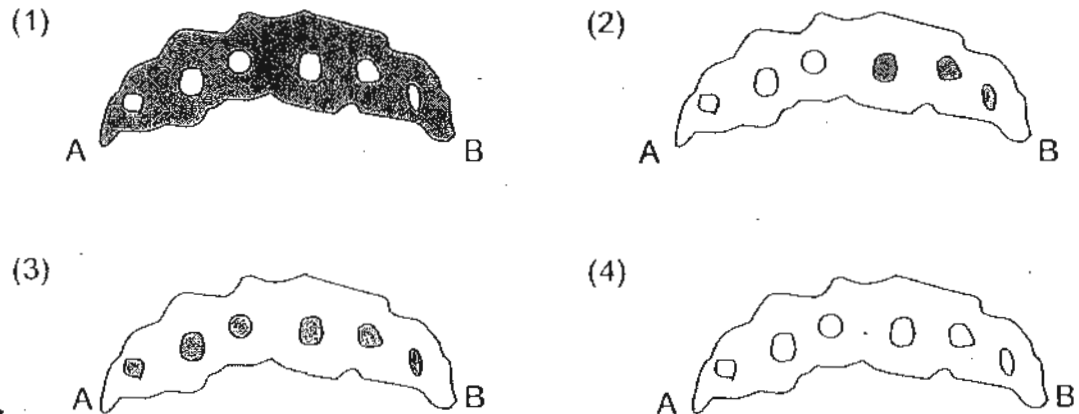

13. Which of the following statements show the similarities between the transport system in plants and circulatory system in animals?

- A Both are made of tubes.
- B Both transport materials.
- C Both involve the movement of blood.
- D Both require a pump to transport the materials.

- (1) A and B only
- (2) C and D only
- (3) A, B and C only
- (4) A, B, C and D

14. Study the circuits below carefully. The bulbs used are identical and the batteries are of the same voltage.

(A)

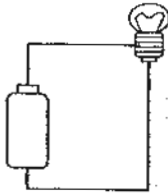

(B)

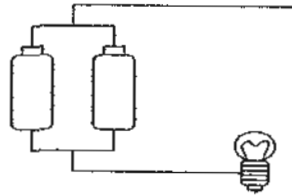

(C)

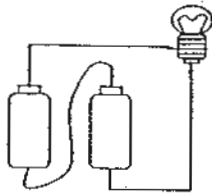

(D)

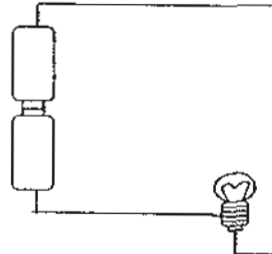

Which bulbs have about the same brightness?

- (1) A and B only
- (2) B and C only
- (3) A, B and D only
- (4) B, C and D only

15. Stella set up a circuit as shown in the diagram below.

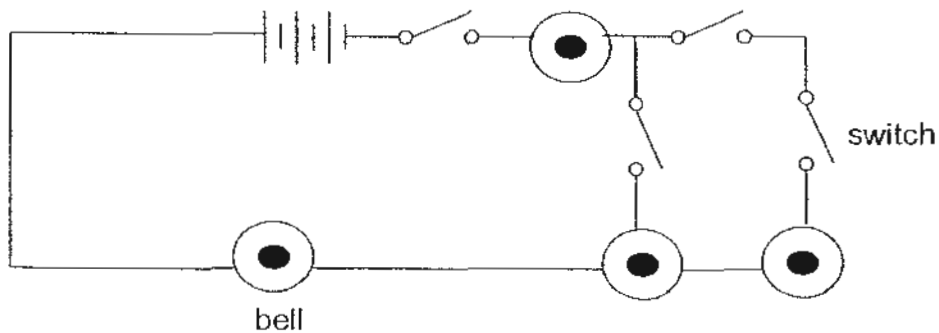

What is the minimum number of switches that Stella has to close in order to ring 3 bells?

- (1) 1
- (2) 2
- (3) 3
- (4) 4

16. The diagram below shows a circuit card with 6 paper clips, A to F. The paper clips were connected with Material X and Y. Material X is an electrical conductor while Material Y is an electrical insulator.

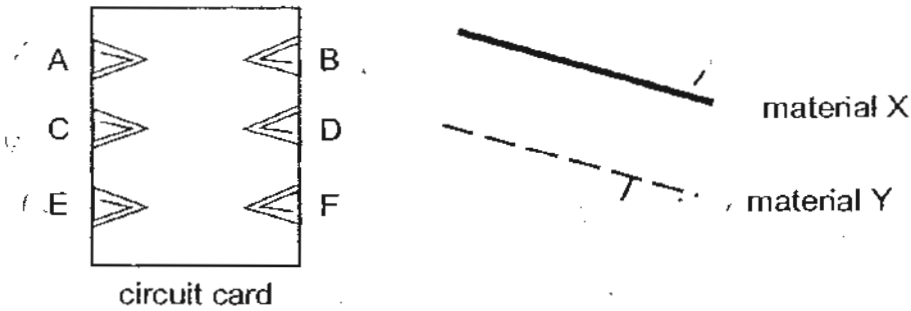

A circuit tester was used to connect the paper clips on the circuit card and the following observations were made.

Paper clips connected	Does the bulb light up?
A and B	Yes
B and C	Yes
C and D	Yes
D and E	No
E and F	Yes

Which one of the following shows how the paper clips on the circuit card were connected?

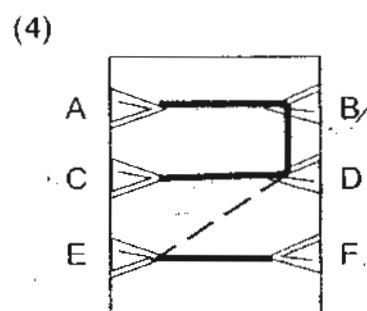
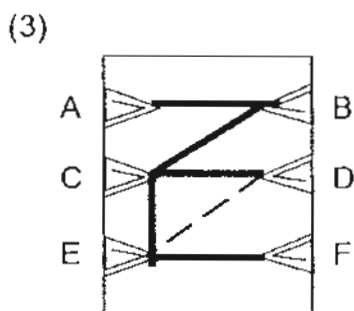
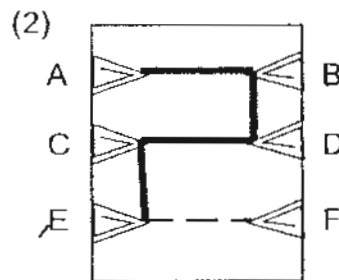
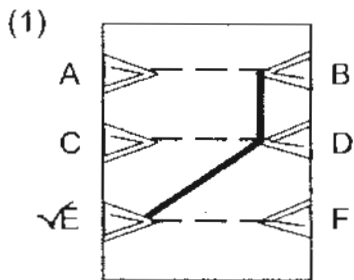

17. Rina wants to find out if the arrangement of bulbs would affect the brightness of the bulbs.

Which two set-ups should she use to ensure a fair test, assuming that all the bulbs are similar and batteries are of equal voltage?

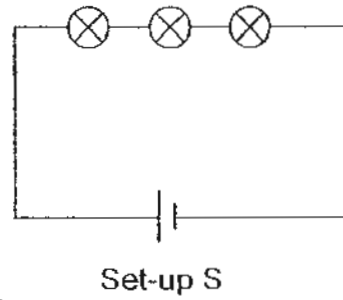
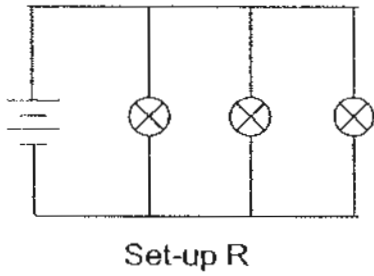
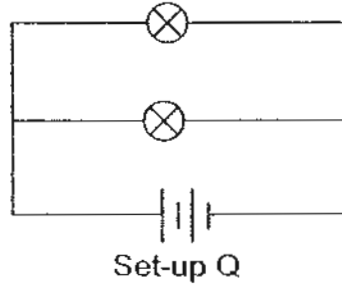
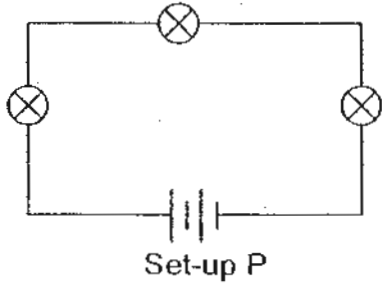

- (1) P and Q
- (2) P and R
- (3) Q and S
- (4) R and S

18. Chandra used different materials W, X, Y and Z to set up four circuits as shown below.

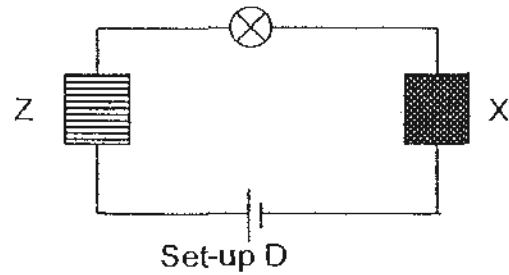
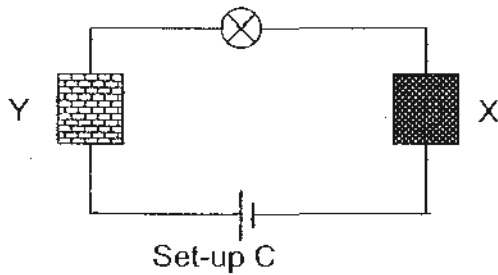
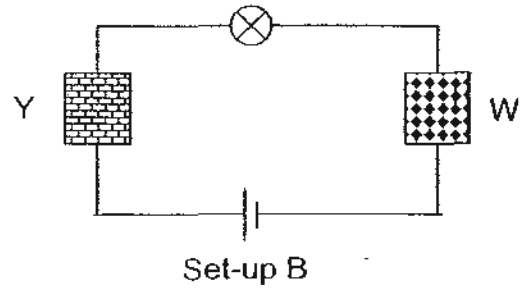
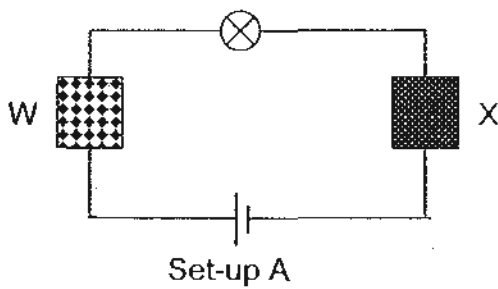

He tested the four circuits. The results of his experiment were shown in the table below.

Set-up	Does the bulb light up?	
	Yes	No
A		✓
B		✓
C	✓	
D	✓	

What could Chandra conclude from the experiment?

- (1) Material Y is a non-conductor of electricity.
- (2) Materials W and Y are conductors of electricity.
- (3) Materials X, Y and Z are conductors of electricity.
- (4) Materials X and Y are non-conductors of electricity.

19. Jia Xin placed an electromagnet near a magnet and a copper rod as shown in the diagram below.

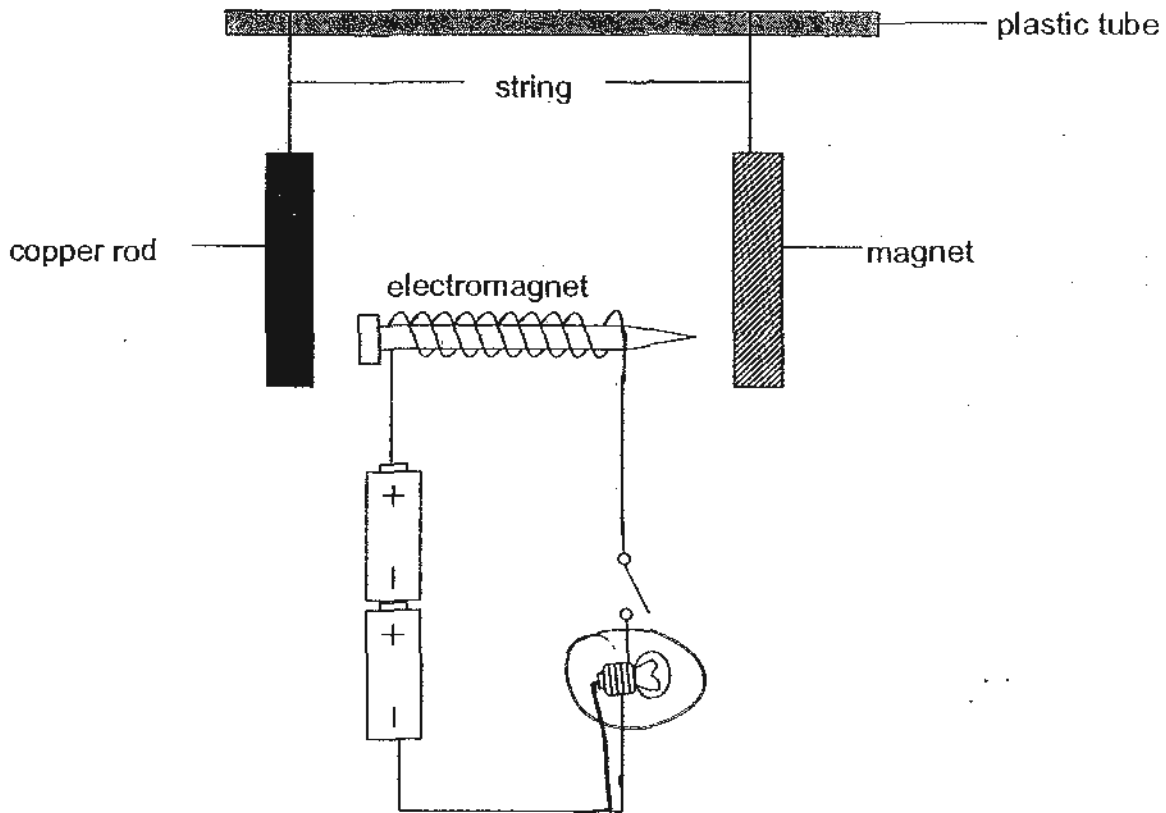

When the switch is closed, which are the most likely observations?

- A The bulb lights up.
 - B The electromagnet will cause the magnet to move.
 - C Both the copper rod and the magnet will be attracted.
 - D The copper rod will not be attracted to the electromagnet.
-
- (1) A and B only
 - (2) C and D only
 - (3) B and D only
 - (4) A, B and D only

20. Study the flow chart below carefully.

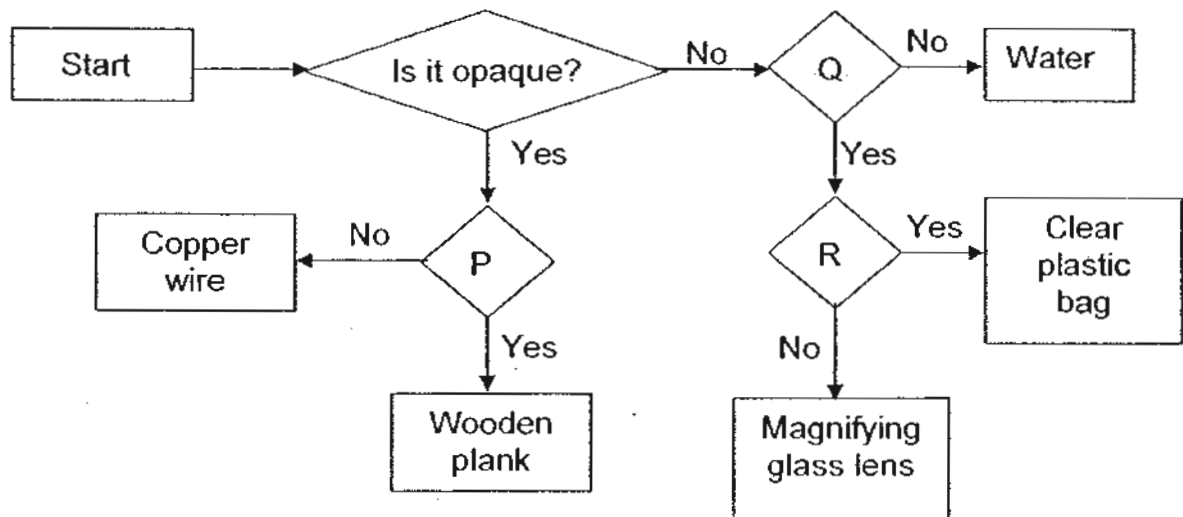

Which one of the following is the most suitable set of questions about the properties represented by P, Q and R?

	P	Q	R
(1)	Is it a good conductor of heat?	Does it have a definite volume?	Is it bendable?
(2)	Is it durable?	Does it occupy space?	Is it lightweight?
(3)	Is it an electrical insulator?	Does it take the shape of its container?	Is it transparent?
(4)	Is it a poor conductor of heat?	Does it have a definite shape?	Is it flexible?

21. The functions of blood in our body are to _____

- A keep the lungs breathing
- B defend the body against germs
- C transport oxygen and carbon dioxide in the body
- D transport digested food from the small intestines to all parts of the body

- (1) A and B only
- (2) C and D only
- (3) B, C and D only
- (4) A, B, C and D

22. Purany has a pencil box that makes use of 2 sets of magnets, X and Y, to shut itself tight, as shown in the diagram below.

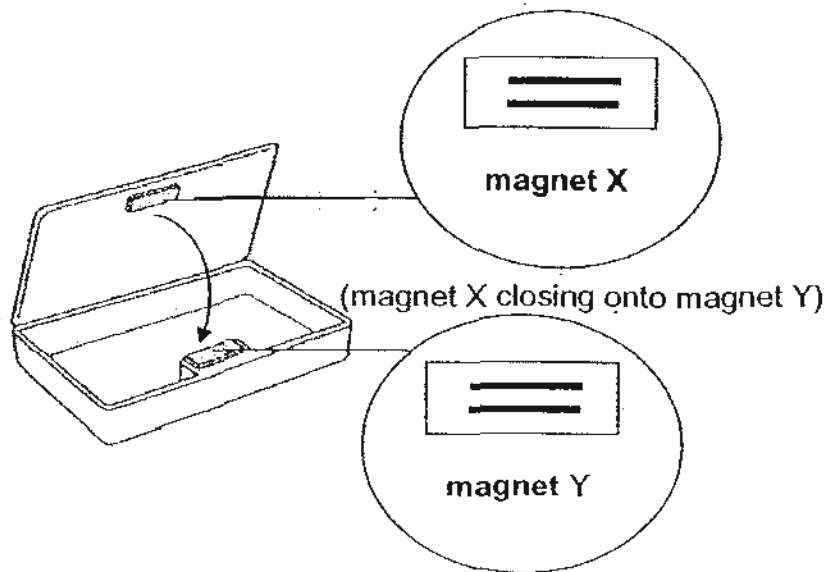

Which one of the following shows the arrangement of the 2 sets of magnets?

- (1) Magnet X

S	S
N	N

 (2) Magnet X

N	N
S	S
- Magnet Y

N	N
S	S

 Magnet Y

S	S
N	N
- (3) Magnet X

N	S
S	N

 (4) Magnet X

S	N
N	S
- Magnet Y

N	S
S	N

 Magnet Y

N	S
S	N

23. Which of the following statements about oxygen are ~~not~~ correct?

- A It is used for burning.
- B It is used for respiration.
- C It is used to make fertilisers.
- D It is used to make carbonated drinks.

- (1) A and B only
- (2) B and C only
- (3) A and D only
- (4) C and D only

24. The chart below shows some parts of a body system.

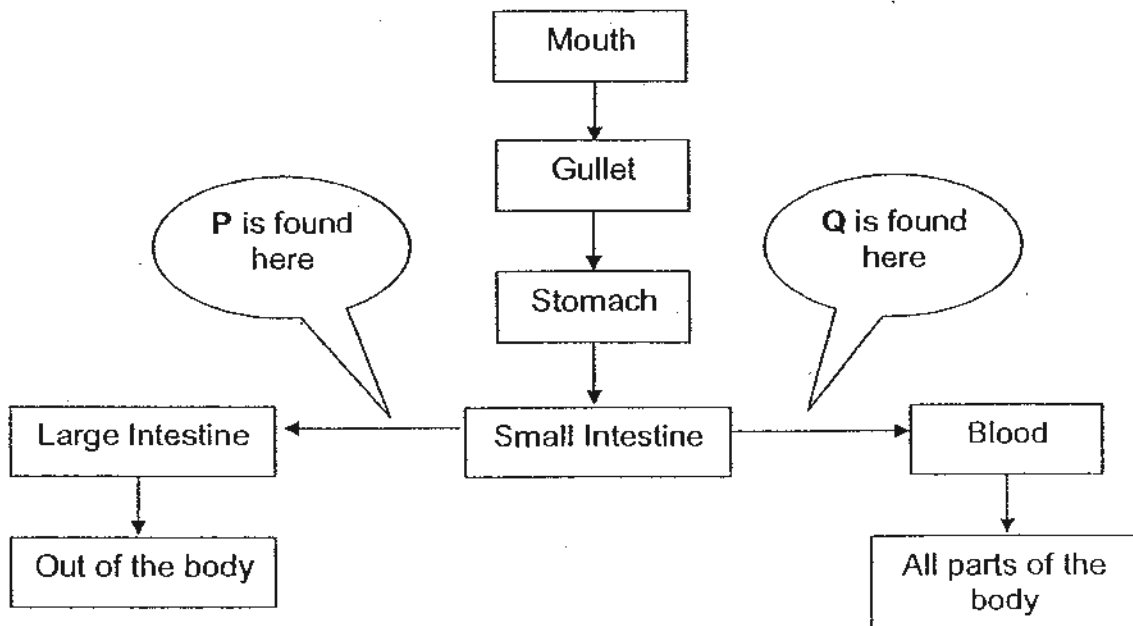

What do P and Q represent?

	System(s)	P	Q
(1)	Digestive System	Carbon dioxide	Digested Food
(2)	Circulatory System	Carbon dioxide	Oxygen
(3)	Digestive & Circulatory System	Undigested food	Digested Food
(4)	Respiratory & Digestive System	Carbon dioxide	Digested Food

25. The statements below describe how carbon dioxide is being removed from the body when we breathe out.

- A The veins carry the blood into the heart.
- B The blood carries the carbon dioxide into the lungs.
- C The blood from all parts of the body carries carbon dioxide.
- D The blood rich in carbon dioxide is carried away from the heart.
- E The blood exchanges carbon dioxide for oxygen and the carbon dioxide is removed from the body when we breathe out.

Which of the following show the correct sequence of how carbon dioxide is being removed from the body?

- (1) D → A → C → E → B
- (2) B → C → A → D → E
- (3) C → A → D → B → E
- (4) A → B → D → E → C

26. Yusoff bought some fishes and put them in a container of water as shown below.

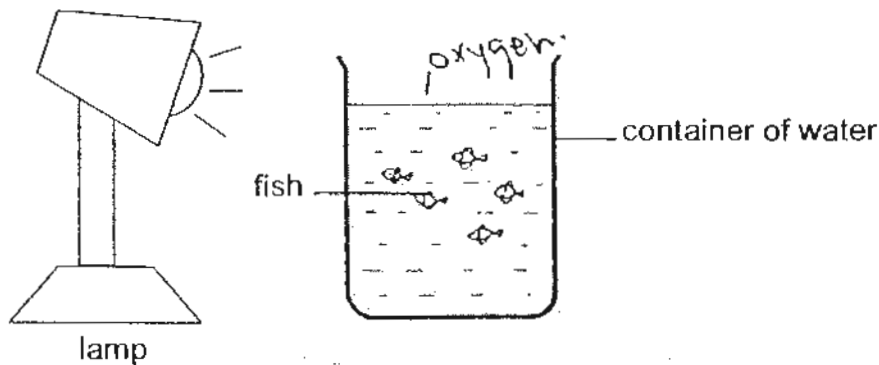

He observed that the fishes kept going up to the surface of the water. What should he do to reduce the number of times the fishes going up to the surface of water?

- (1) Add food to the water. x water
- (2) Add soil into the water. x water
- (3) Add more fishes into the water.
- (4) Add water plants into the water.

27. Study the flow chart shown below carefully.

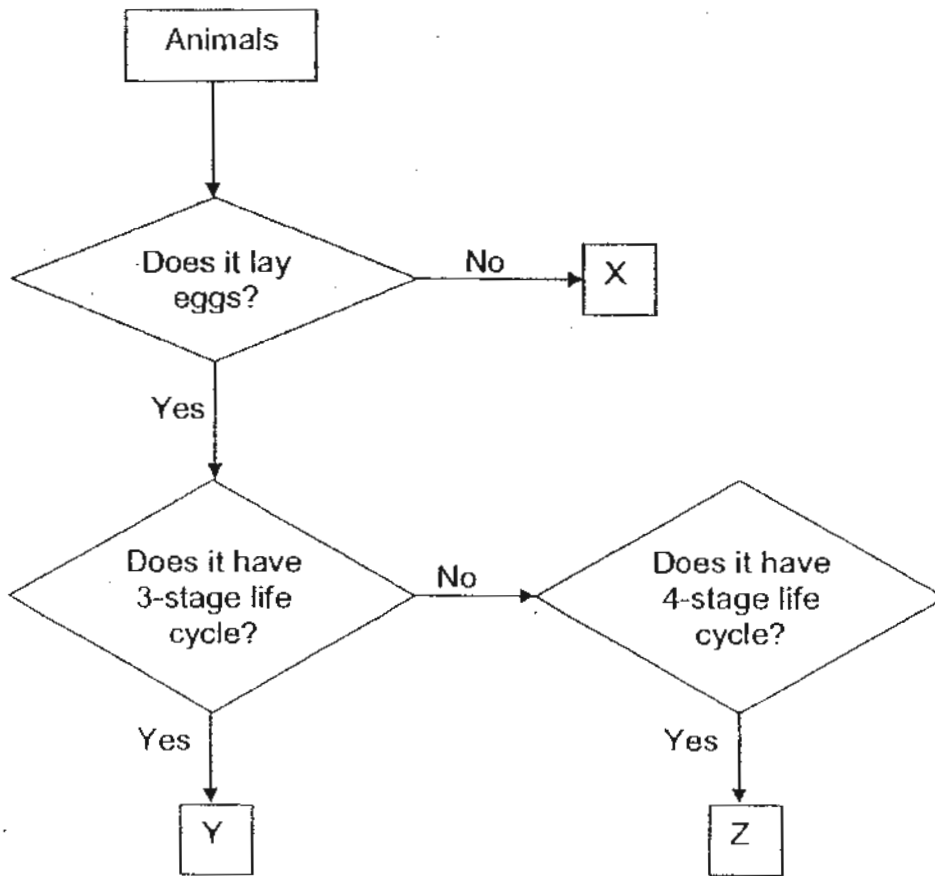

What can the animals X, Y and Z be?

	X	Y	Z
(1)	Cow	Duck	Moth
(2)	Horse	Cow	Duck
(3)	Grasshopper	Duck	Cow
(4)	Duck	Moth	Cow

28. A wooden block and a glass block have shapes cut out from them as shown below.

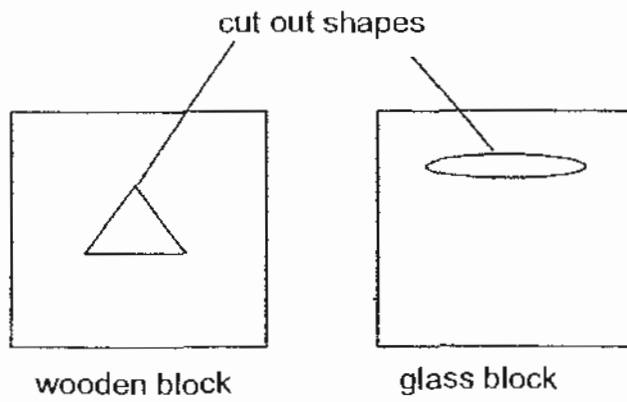

The blocks are then placed in line with each other and glued together. A light source is brought near the glued blocks.

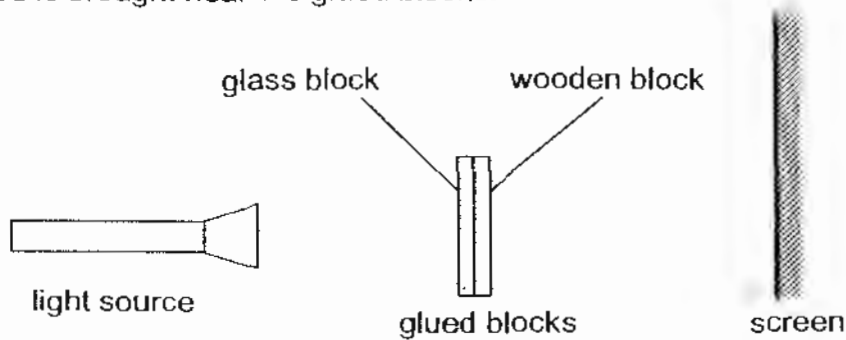

Which one of the following is most likely to be the shadow formed on the screen?

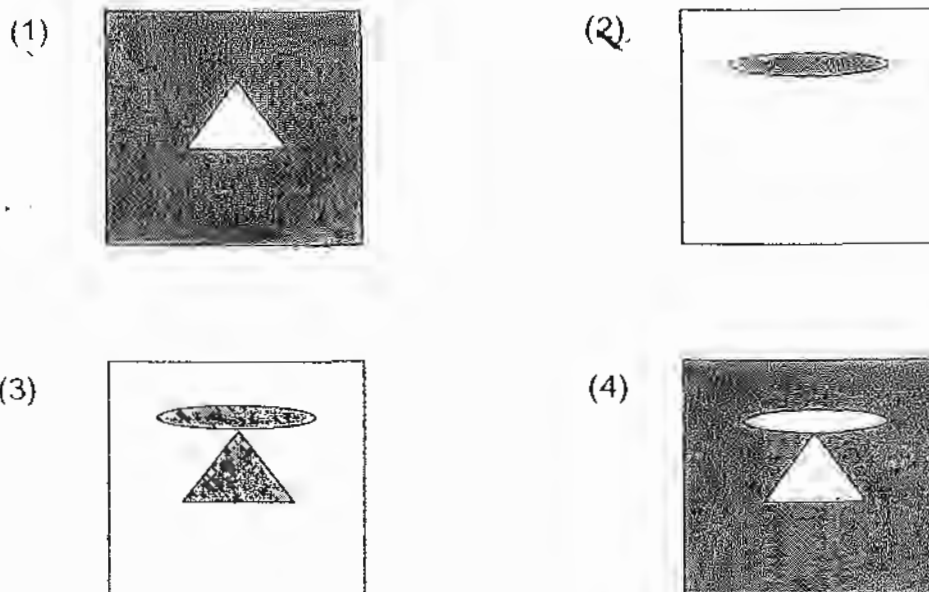

29. Study the set-up shown below.

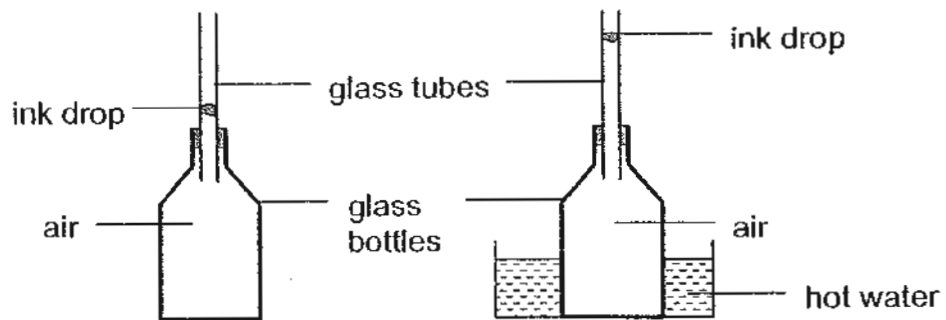

What does this experiment show us about the properties of air?

- A Air has mass.
 - B Air occupies space.
 - C Air expands on heating.
 - D Air has definite shape.
- (1) A and D only
(2) B and C only
(3) B, C and D only
(4) A, B, C and D

30. A box contains an unknown object Q which is connected to Wire P and R.

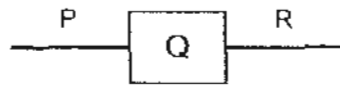

Nina joins wire P to A and wire R to B and the bulb lights up.

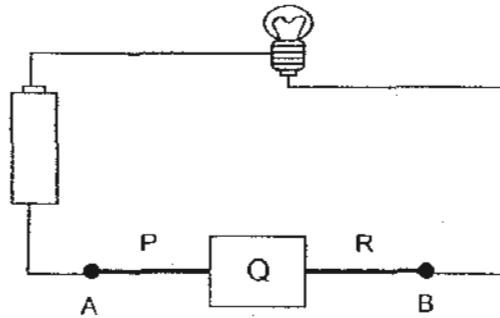

However, when Nina connects wire R to A and wire P to B as shown below, the bulb did not light up although it is in working order.

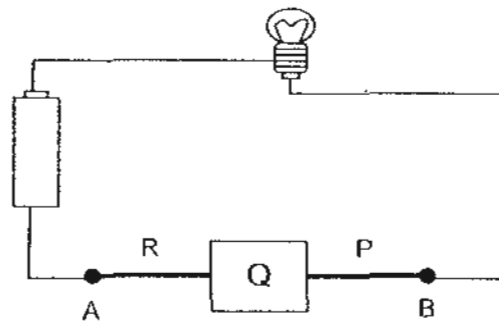

Which of the following objects could be in the box?

(1)

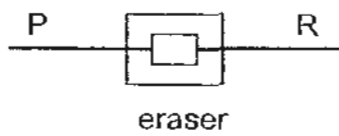

(2)

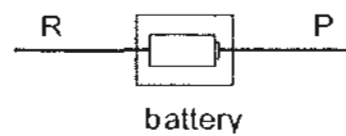

(3)

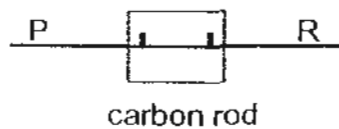

(4)

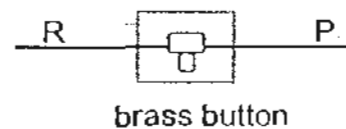

End of Section A

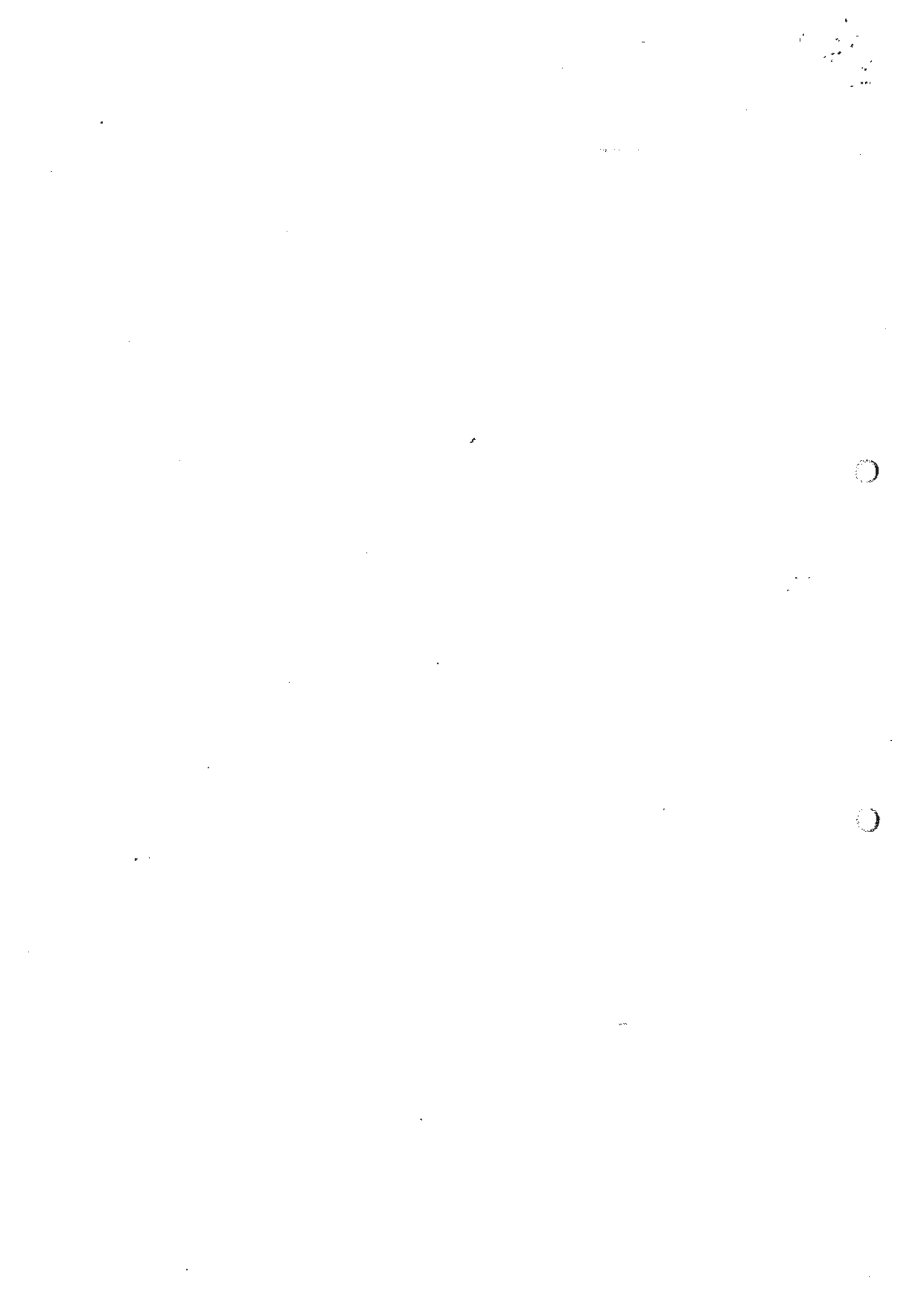

Name: _____ ()

Class: Primary 5 _____

CHIJ ST NICHOLAS GIRLS' SCHOOL (Primary)



德 純 頭 學

Primary 5 2010 First Smestral Assessment SCIENCE

BOOKLET B

12 May 2010

Total Time for Booklets A and B: 1 h 45 min

14 questions
40 marks

Do not open this booklet until you are told to do so.
Follow all instructions carefully.
Answer all questions.

Booklet A	60
Booklet B	40
Total	100

Parent's Signature / Date _____

This paper consists of 16 printed pages.

Section B: 40 marks

For questions 31 to 44, write your answers in this booklet.

The number of marks available is shown in the brackets [] at the end of each question or part question.

31. During one of the Science lessons, Denise's teacher gave her a cell to study under the microscope. She drew out the cell that she observed as shown in the picture below.

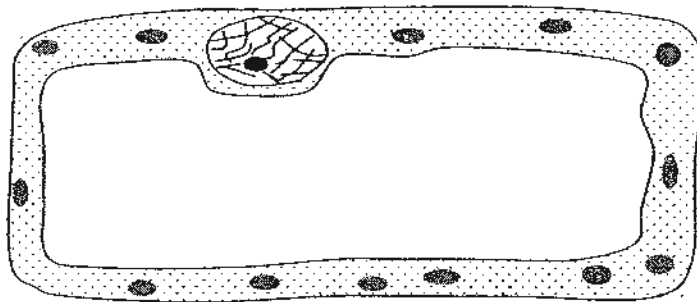

She was unable to identify the cell as she realised that a part of the cell was damaged and missing.

- (a) Name the part of the cell that was missing. [1]

- (b) What is the function of this missing cell part? [1]

- (c) Other than the part that was missing, what other observation of the cell could help Denise confirm the type of the cell that she was observing? [1]



32. Johan carried out different activities for the same duration. The activities are represented by the letters A, B, C and D. He then measured his breathing rate and pulse rate after completing each activity. The results are recorded in the table shown below.

Activity	Pulse rate (no. of beats per minute)	Breathing rate (no. of times inhaled and exhaled per minute)
A	65	30
B	75	35
C	110	50
D	135	65

- (a) What is the relationship between his pulse rate and his breathing rate? [1]

- (b) Using the information given above, match the activities A, B, C and D with the type of exercise below. [2]

	Type of Exercise	Activity
(i)	Resting	
(ii)	Brisk walking	
(iii)	Watching a thriller movie	
(iv)	Sprinting a 100m race	

- (c) Explain why Johan's heartbeat and breathing rate increases in activity D? [1]

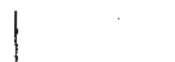

33. Kumar made a model, using the apparatus shown below to show the action of the diaphragm in the human respiratory system.

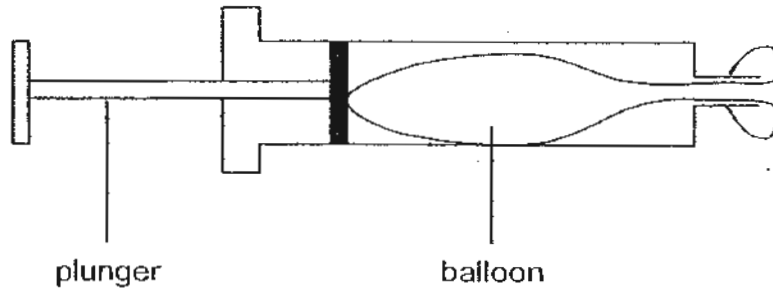

- (a) Write down the organs that the parts of the apparatus represent in the human respiratory system : [1]

(i) The balloon : _____

(ii) The plunger : _____

- (b) What will happen to the balloon when the plunger is pulled back?

- (c) Explain your answer in (b). [1]



34. Yan Yi carried out an experiment on a stem of a plant as shown below. She observed that only the leaves at position Y died after two days.

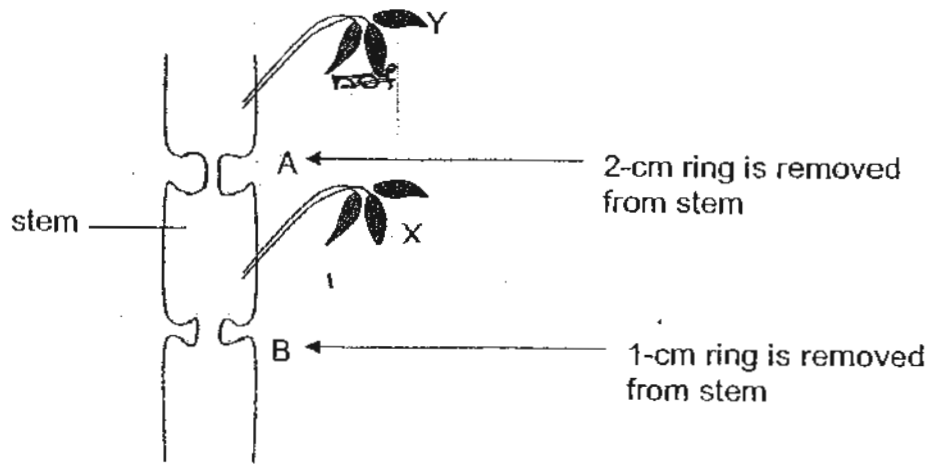

- (a) In the diagram below, shade the part of the stem that carries water. [1]

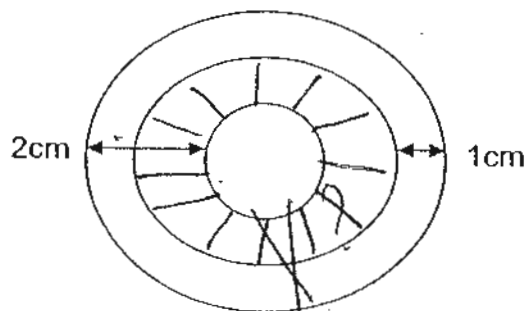

- (b) Explain why the leaves at position Y died after 2 days. [1]

35. The diagram below shows the human circulatory system. X and Y are the blood vessels in the human circulatory system.

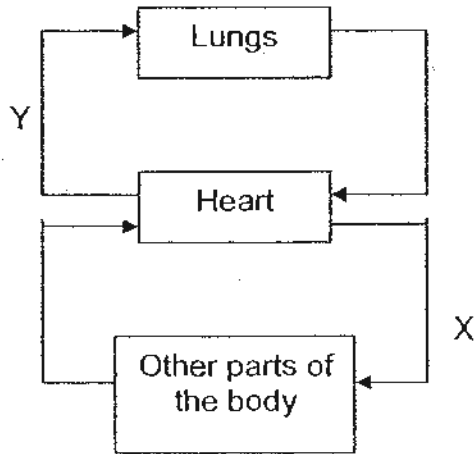

(a) Indicate below which blood vessels carry 'blood rich in oxygen' and 'blood poor in oxygen'. [1]

(i) X : _____

(ii) Y : _____

(b) Read the statements in the following table and decide whether they are true or false. Put a tick (✓) in the correct column against each statement. [2]

	Statement	True	False
(i)	Digested food is transported in X.		
(ii)	Heart is an organ that pumps blood all around the body.		
(iii)	Waste materials are carried from other parts of the body and straight to the lungs.		
(iv)	Undigested food is absorbed in the small intestine before being transported to other parts of the body.		



36. Sherlyn set up an experiment as shown below. She placed a stalk of celery in each jar. She poured equal amount of coloured water and oil into Jar P and Jar Q. She then placed the two jars near a window.

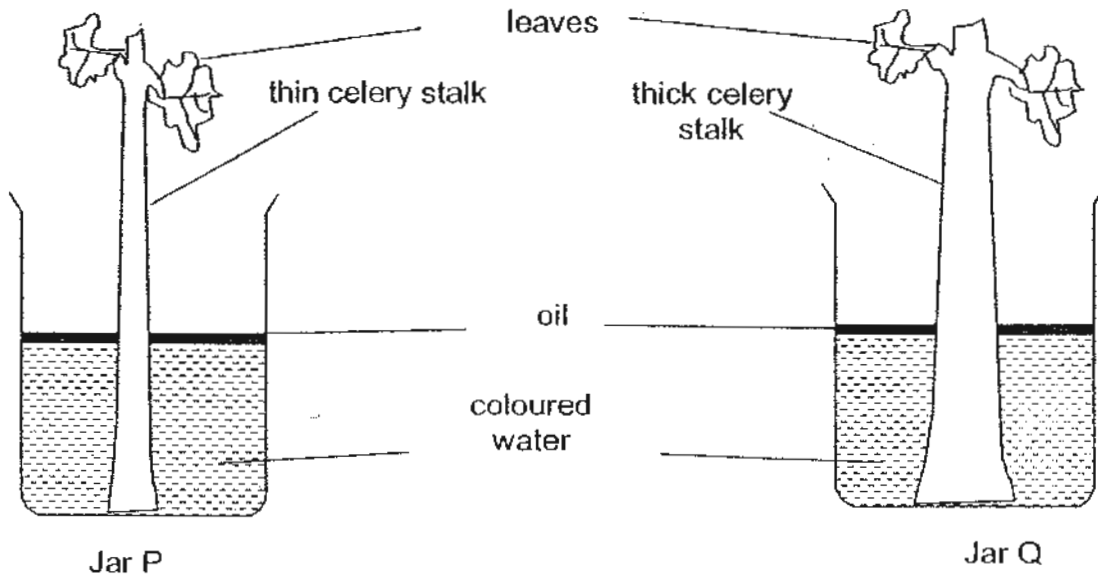

The water level was checked daily over a period of 4 days and the results were recorded in the graph below.

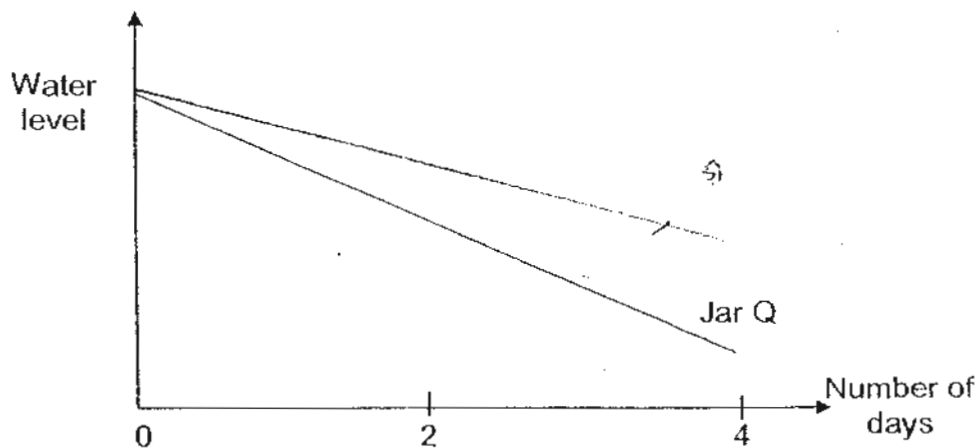

- (a) Draw another line in the graph above to indicate the change in the water level in Jar P over the same period of time. [1]
- (b) What was the aim of Sherlyn's experiment? [1]

37. Study the classification chart below.

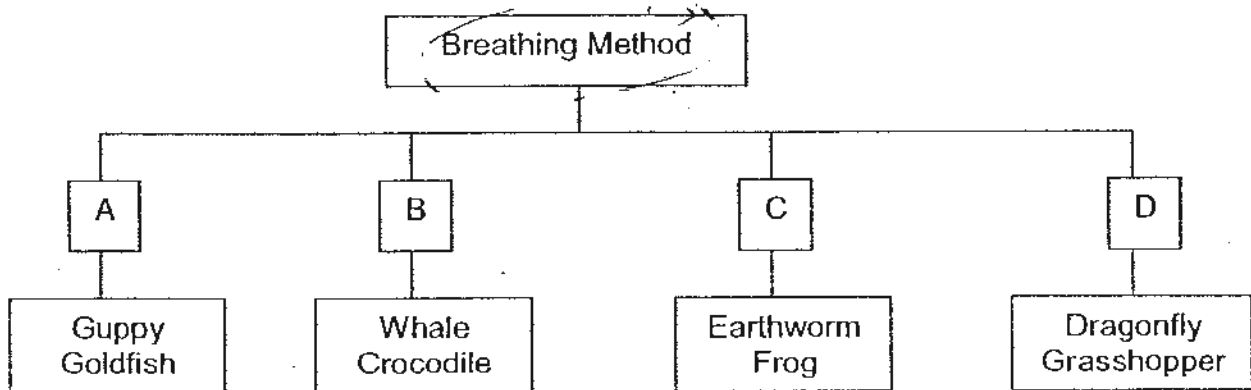

(a) Based on the classification chart above, write down the correct heading for the groups, A, B, C and D. [2]

A: _____

B: _____

C: _____

D: _____

(b) In which group would "dragonfly nymph" be grouped in? [1]



38. Study the circuit diagram below.

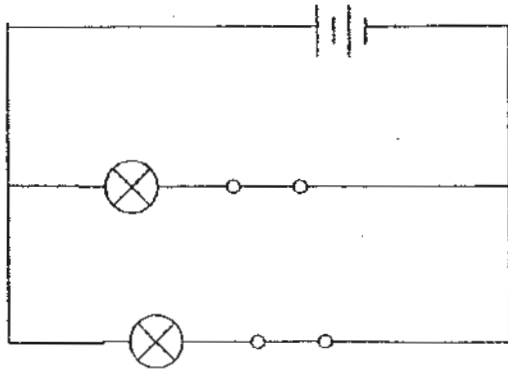

Based on the circuit diagram above, draw a circuit using the electrical components given in the space below. [3]



wires



batteries

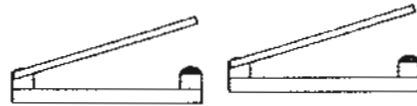

switches

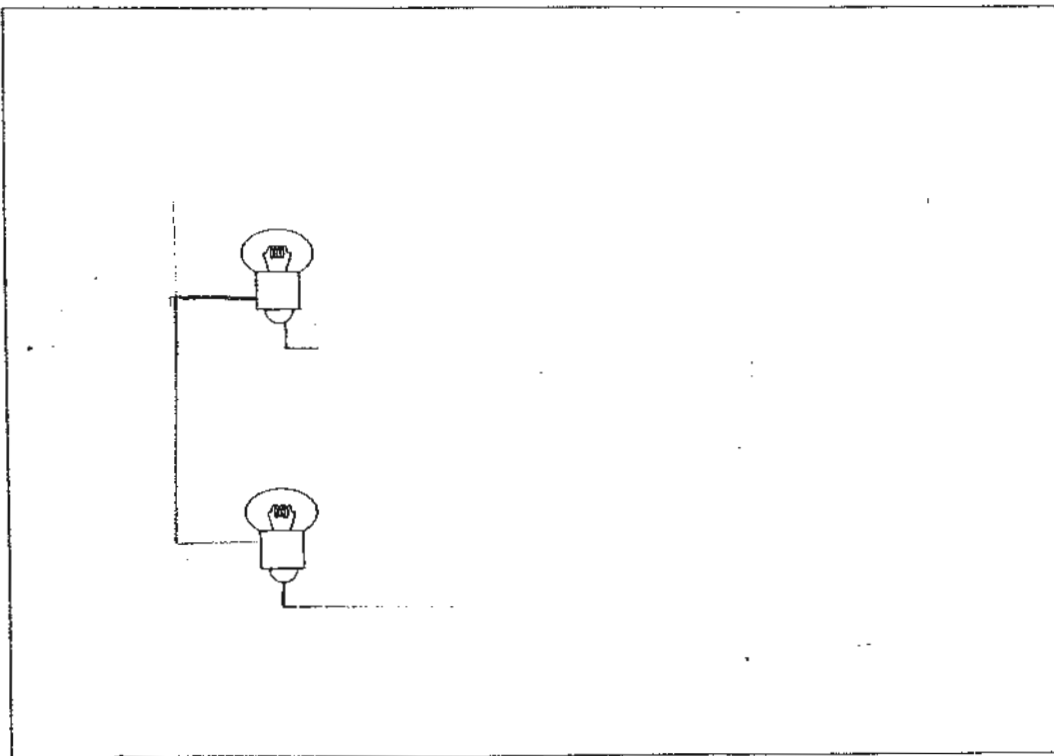

39. Study the diagram below carefully.

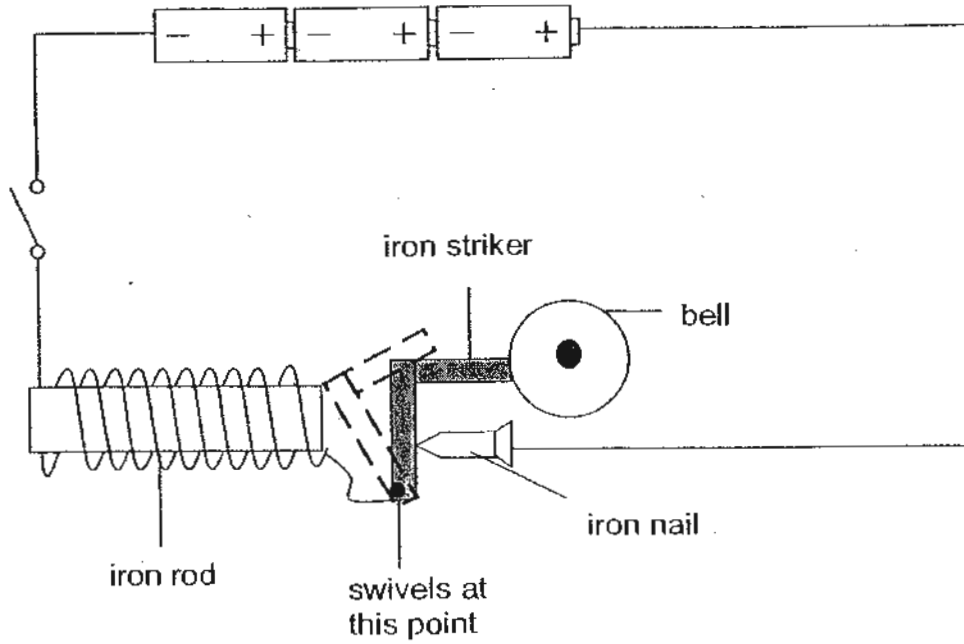

(a) Explain clearly what happens when the switch is closed. [2]

(b) What would happen if the iron rod is replaced with an aluminium rod instead? Explain your answer. [1]

- 40(a) Anita wanted to investigate which rods, W, X, Y or Z is a conductor of electricity.

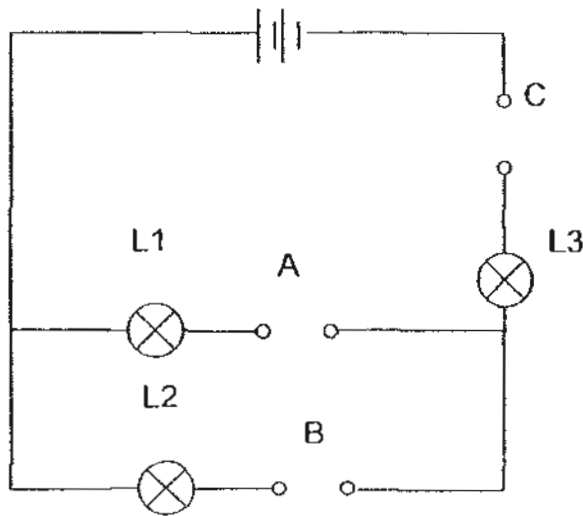

She placed each of the 4 rods as described in the table below in the circuit shown above at point A, B and C and recorded her observations of the 3 light bulbs, L1, L2, L3 in the table below.

A	B	C	L1	L2	L3
X	Y	W	Not lighted	Not lighted	Not lighted
X	W	Y	Lighted	Not lighted	Lighted
W	Y	Z	Not lighted	Not lighted	Not lighted
Z	Y	X	Not lighted	Lighted	Lighted

Based on the results, which rods are conductors of electricity? [1]



40(b) Anita rearranged the circuit and added a battery and 2 bulbs, L4 and L5 as shown below.

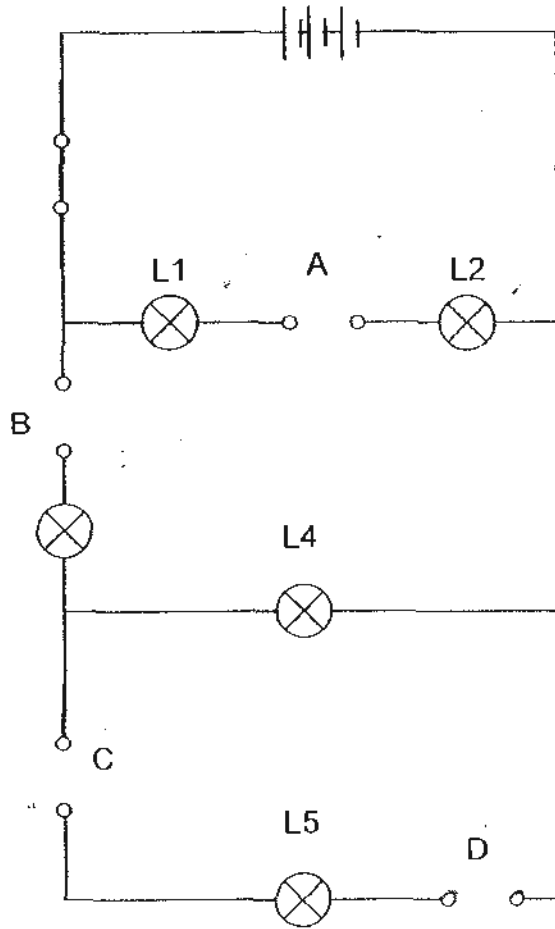

From the results in part (a), where should she place rods, W, X, Y and Z if she wants the most number of bulbs to light up? [2]

A: _____

B: _____

C: _____

D: _____



41. Study the two circuit diagrams below carefully.

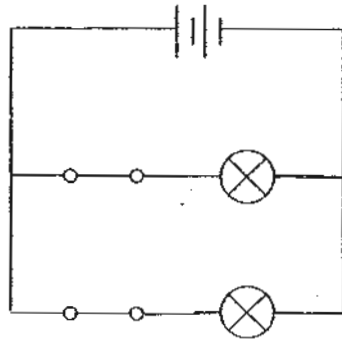

Circuit A

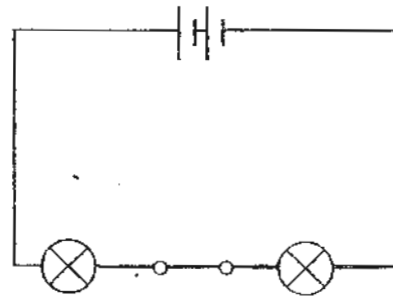

Circuit B

- (a) What is the advantage of circuit A? [1]

- (b) Which circuit would you choose for your house? Explain your answer. [2]

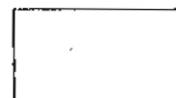

42. Alicia carried out an experiment using the set-up as shown below.

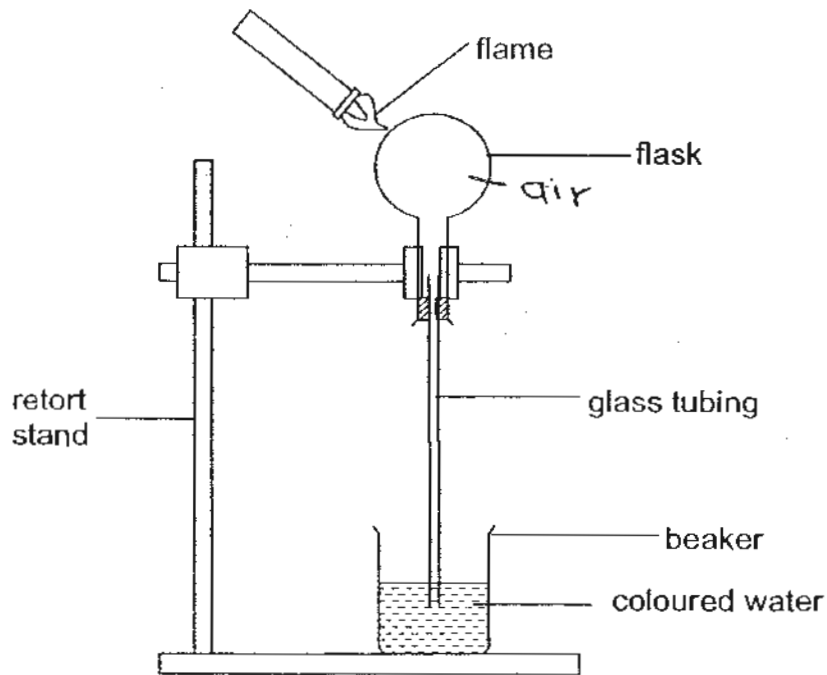

She heated the flask gently with a flame. After some time, she observed some bubbles in the coloured water of the beaker.

(a) How were the bubbles formed? [1]

(b) What would Alicia observe if she removed the flame in the set-up and allowed the flask to cool? [1]

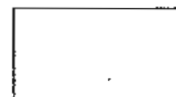

43. In the diagram shown below, an object is placed in front of the torch and a shadow is formed on the screen.

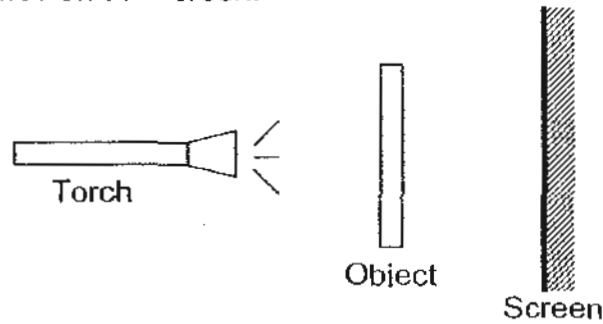

The graph below shows the amount of light that passes through three objects, A, B and C.

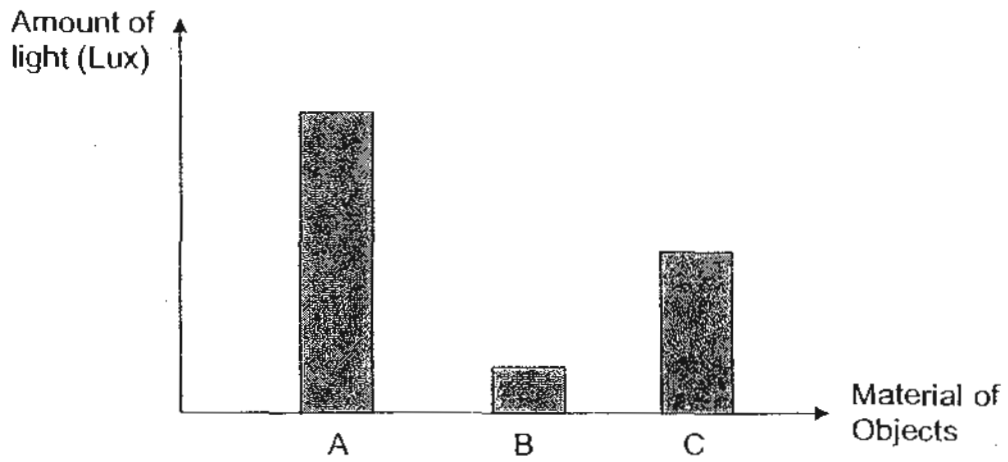

- (a) Based on the graph above, write down the letters A, B and C that represent the object used. [1½]

Frosted glass : _____

Paper : _____

Clear plastic folder: _____

- (b) The object is then replaced by a red cellophane paper. Which letter A, B or C in the graph would best represent red cellophane paper? Explain your answer. [1½]

44. Bella wanted to test the hypothesis that the presence of water plants increases the survival rate of ~~fish~~ fish. She had the following items:

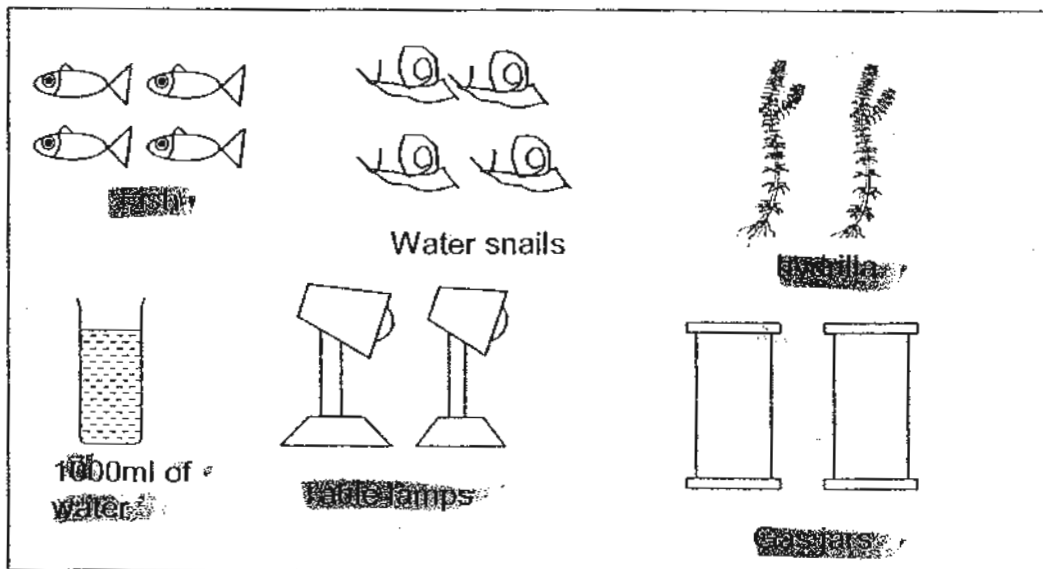

- (a) Draw and label in the space provided below the control set-up she should prepare. [2]

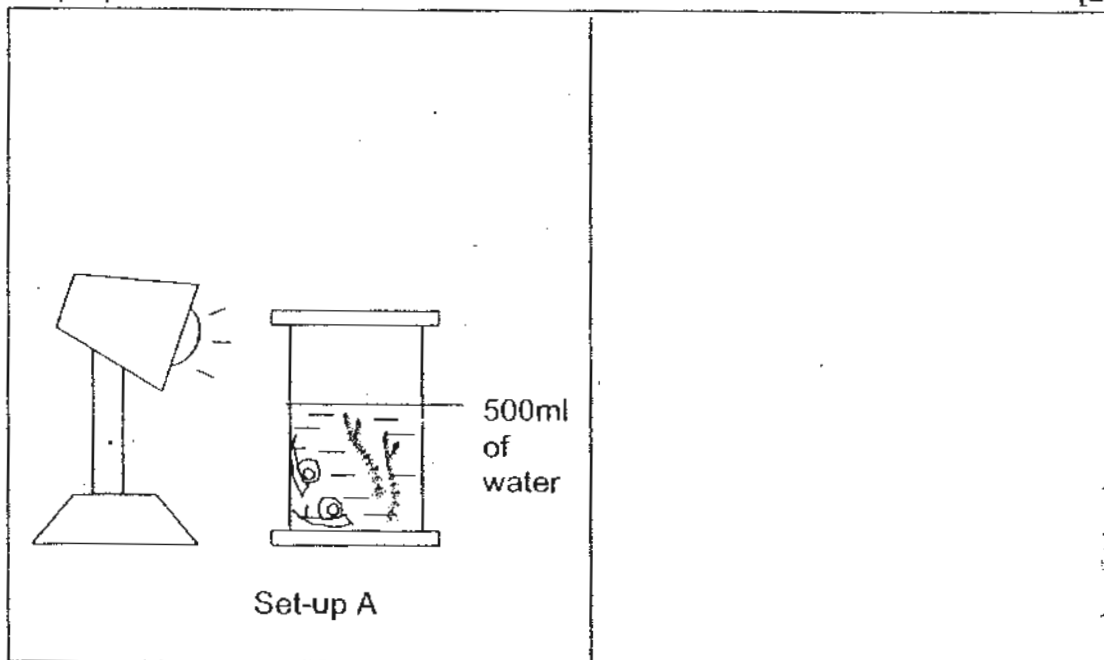

- (b) What would happen to the hydrilla in set-up A if the set-up is placed in the dark instead? [1]

End of Paper



ANSWER SHEET

EXAM PAPER 2010

SCHOOL : CHIJ PRIMARY
SUBJECT : PRIMARY 5 SCIENCE

TERM : SA1

Q1	Q2	Q3	Q4	Q5	Q6	Q7	Q8	Q9	Q10	Q11	Q12	Q13	Q14	Q15	Q16	Q17
1	4	3	2	3	1	4	3	4	3	4	2	1	1	2	4	2

Q18	Q19	Q20	Q21	Q22	Q23	Q24	Q25	Q26	Q27	Q28	Q29	Q30
3	3	4	3	3	4	3	3	4	1	1	2	2

- 31)a)The cell wall.
b)It gives the cell a fixed shape.
c)The presence of chloroplasts confirm that it is a plant cell.

- 32)a)The higher the pulse rate, the higher his pulse rate.
b)A, C, B, D
c)His heart pumps faster to supply blood with dissolved oxygen and digested food to parts of the body to produce energy. His breathing rate increases so as to take in more oxygen.

- 33)a)i)Lungs ii)Diaphragm
b)It will inflate.
c)When the plunger is pulled back, there is more space in the syringe, so air enters to take up the space in the balloon, inflating the balloon.

34)a)

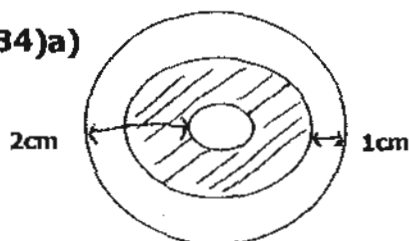

- b)As the food-carrying tubes and water-carrying tubes were removed, it will not have any food or water, and so when it has no water at all, it will die.

- 35)a)i)blood rich in oxygen ii)blood poor in oxygen
b)i)T ii)T iii)F iv)F

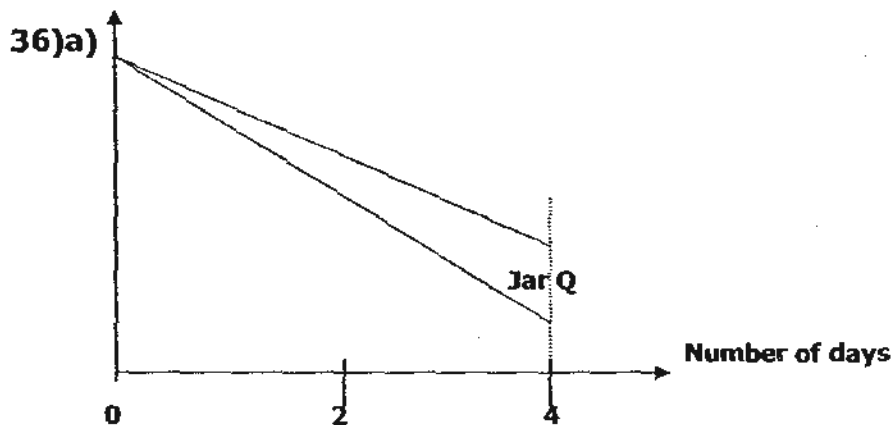

b) To observe whether the thickness of the stalk will affect the amount of water it takes up.

37)a) A: Gills B: Lungs C: Skin D: Spiracles

b) A.

38)

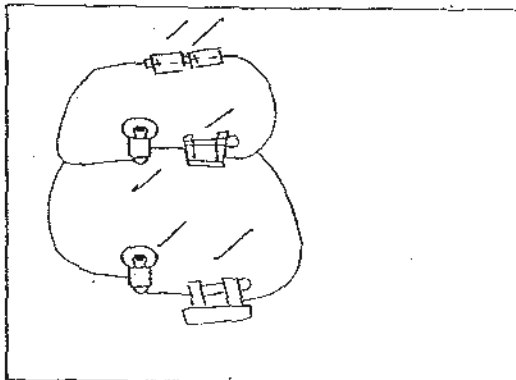

39)a) When the switch is closed, electric current would flow through the circuit, making the iron rod an electro-magnet, attracting the iron striker, when the circuit is broken, the striker hit the bell.

b) The bell will not ring as the aluminium foil will not be an electro-magnet.

40)a) Y and X.

b) A: Y B: X C: W D: W

41)a) If one bulb fuses, the other bulb will still light up.

b) Circuit A. When one bulb fuses, the other bulbs can still light up because electric current can flow through by another path.

42)a) Air inside the glass expanded when heated and escaped through the glass tubing into the water as bubbles.

b) The bubbles will stop forming.

43)a)C, B, A

b)C. The red cellophane paper is translucent and it allows only some light to pass through.

44)a)

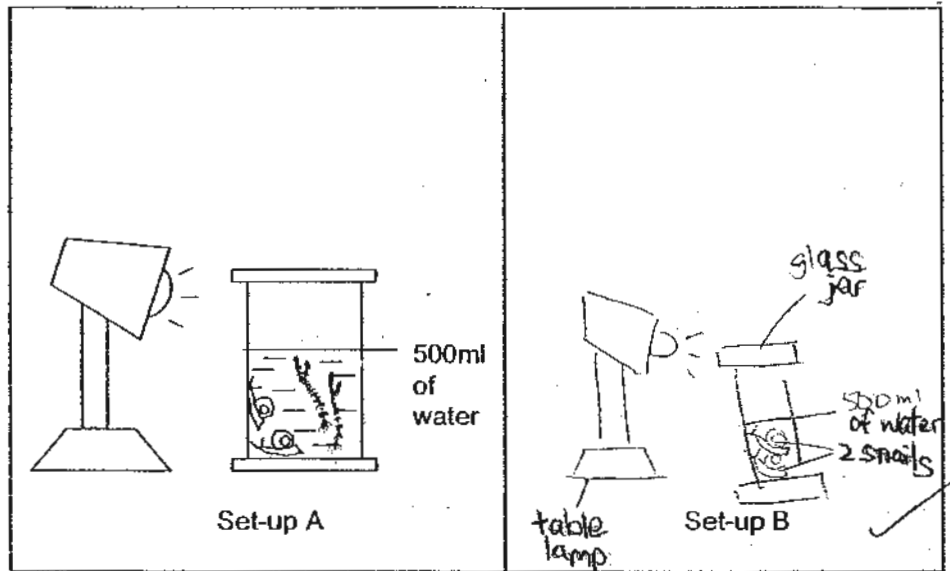

b)It will not photosynthesis and take in carbon dioxide and give out oxygen.