



HENRY PARK PRIMARY SCHOOL
2010 SEMESTRAL EXAMINATION 2
PRIMARY 5 SCIENCE

Booklet A

Name: _____ ()

Class: Primary 5 _____

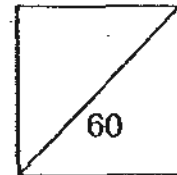

30 Questions
60 Marks

Total Time for Booklet A and B: 1 h 45 min

DO NOT OPEN THIS BOOKLET UNTIL YOU ARE TOLD TO DO SO.

READ AND FOLLOW INSTRUCTIONS CAREFULLY.

PART 1 (60 marks)

For each question from 1 to 30, four options are given. One of them is the correct answer. Make your choice (1,2, 3 or 4). Shade the correct oval (1,2,3 or 4) on the Optical Answer Sheet.

1. The diagram below shows the set-up for 4 identical containers W, X, Y and Z, which are filled with 20 ml of tap water and fitted with air tight lids, and placed at different locations.

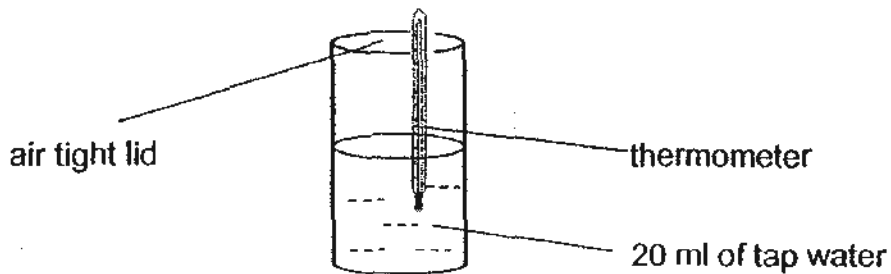

The table below shows the change in the temperature inside the containers at the start and at the end of the experiment.

Temperature of water inside the container	Container W	Container X	Container Y	Container Z
At the start of the experiment	100°C	29°C	-10°C	-29°C
At the end of the experiment	10°C	100°C	-29°C	100°C

The water in which container(s) lost heat at the end of the experiment?

- (1) W only
- (2) Y only
- (3) X and Z only
- (4) W and Y only



2. The graph below shows the changes in the volume of water in a beaker over a period of time.

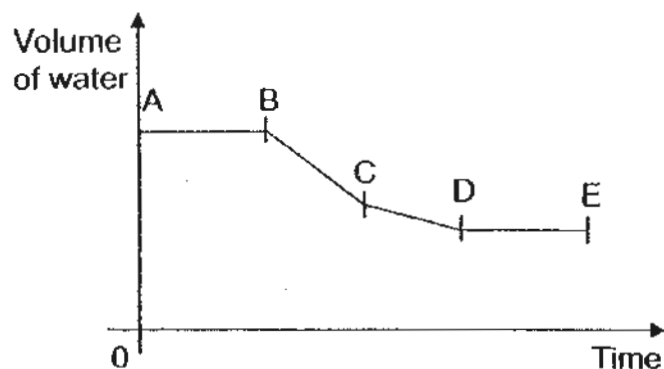

Which part on the graph, AB, BC, CD or DE indicates that the water is probably boiling very quickly?

- (1) AB
 (2) BC
 (3) CD
 (4) DE
3. Jim placed 3 different containers, X, Y and Z filled with equal volumes of water in the same location under the hot sun.

After six hours, he recorded the volumes of water left in each container in the table below.

Volume of water left after six hours (ml)		
Container X	Container Y	Container Z
180	176	182

Which statement(s) below provide(s) a possible explanation for Jim's observation?

- A. The temperature of the water in each container at the start of the experiment was different.
 B. The surrounding temperatures were different for each container.
 C. The water in each container received different amounts of wind.
 D. The exposed surface area of water in each container is not the same.

- (1) B only
 (2) D only
 (3) B and C only
 (4) A and D only



4. The diagram below show the different stages in the water cycle.

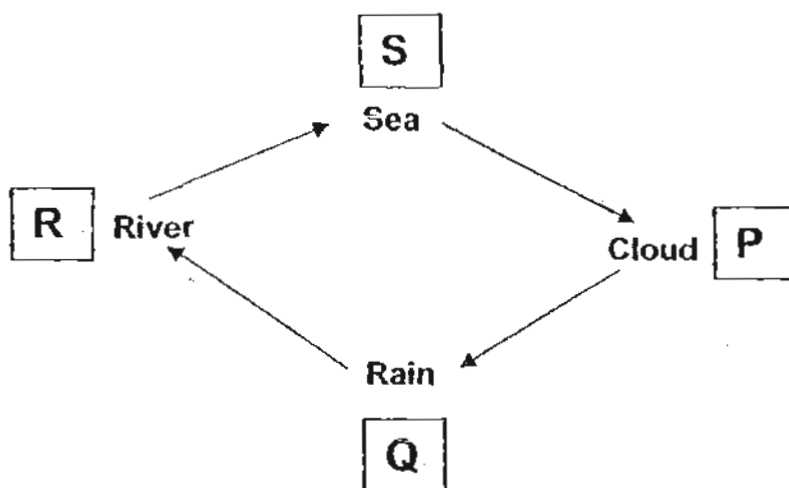

Which process(es) take place from stage S to stage P?

- A. melting
- B. evaporation
- C. condensation

- (1) B only
- (2) C only
- (3) A and B only
- (4) B and C only



5. Study the illustration below of a small village situated on a hill next to a river with a factory located downstream.

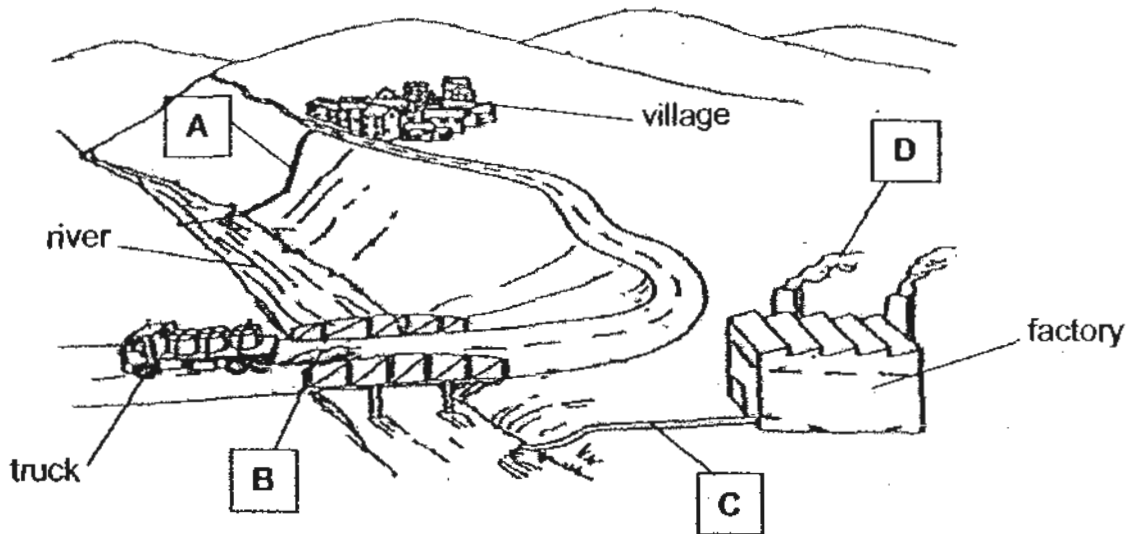

Which of the activity/activities listed below **directly** contribute(s) to the pollution in the river water?

- A: Waste water pipes from the village leading to the river.
- B: Exhaust fumes from a truck.
- C: Water pipes from the river leading to the factory.
- D: Fumes from the chimney of the factory.

- (1) A only
- (2) C only
- (3) B and D only
- (4) A and C only



6. Mary placed Ring Magnet A into a wooden rod. Then she placed Ring Magnet B into the wooden rod. She observed that Ring Magnet B floated above Ring Magnet A as shown in the diagram below.

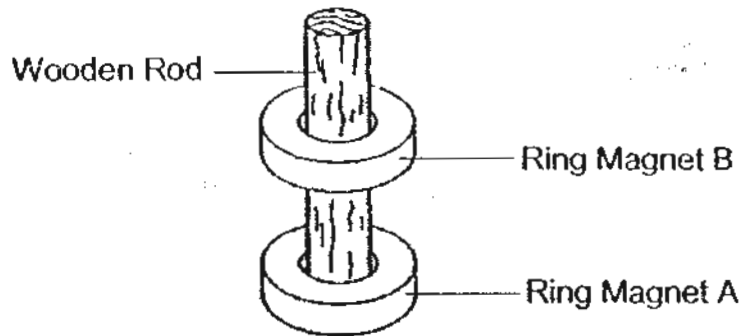

The set-up shows that _____.

- A: Like poles of magnets repel.
- B: Unlike poles of magnets repel.
- C: Unlike poles of magnets attract.
- D: Magnetic force acts at a distance.



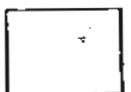

- (1) A and B only.
- (2) A and D only.
- (3) B and D only.
- (4) A, C and D only.

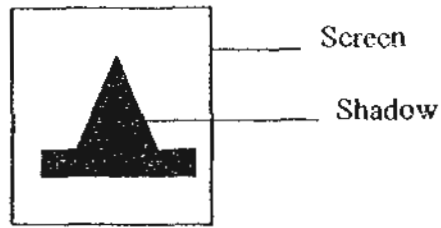

7. An object is placed in front of a light source and a shadow is formed on the screen as shown below.



Which one of the following is the object with the shadow shown?

- (1) 
- (2) 
- (3) 
- (4) 

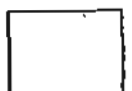

8.

Look at the picture below.

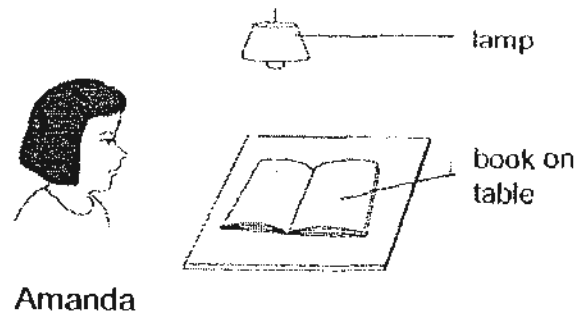

Which one of the following explains why Amanda can see the book on the table?

(1)

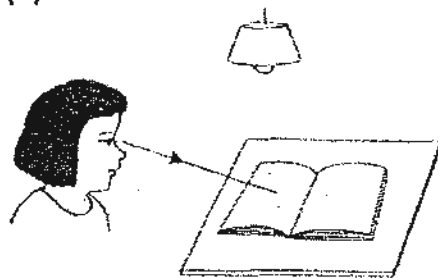

(2)

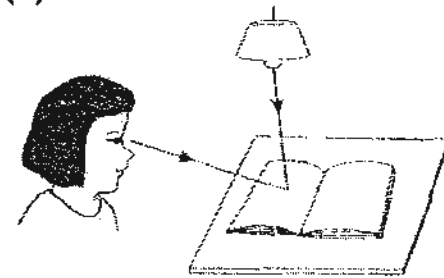

(3)

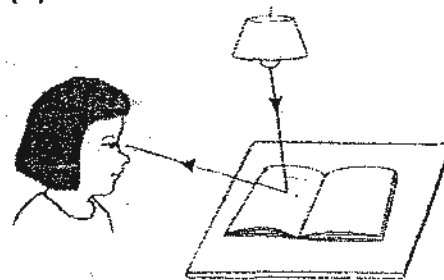

(4)

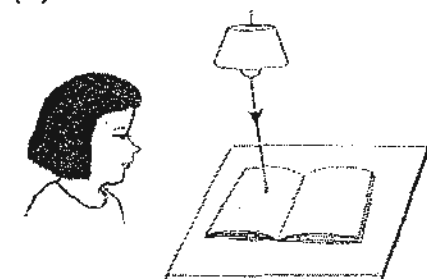

9. A circuit is set up using four bulbs, A, B, C and D and two batteries.

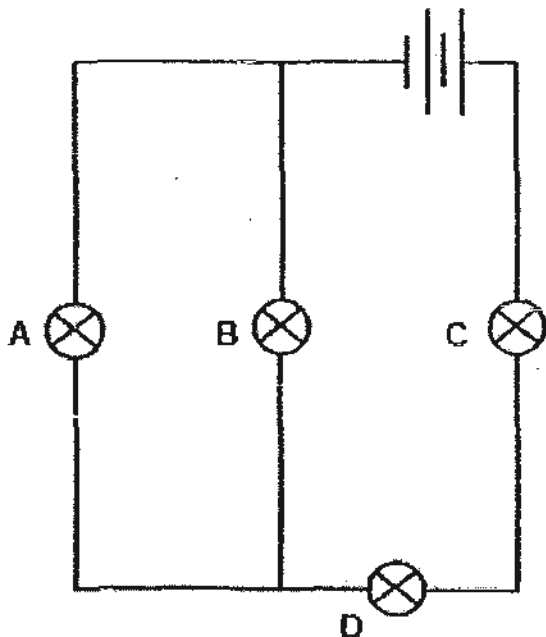

When one of the bulbs fused, the other 3 bulbs remain lit.
Which one of the following is likely to be the fused bulb?

- (1) A only
- (2) A or B
- (3) A or D
- (4) C or D

10. Louis bought 2 different brands of batteries. He wanted to find out which brand of batteries will enable the bulbs to remain lit longer.
Which of the following variables should he keep the same to ensure a fair test?

- A: Number of bulbs
- B: Number of batteries
- C: Brand of batteries
- D: Arrangement of bulbs

- (1) A and B only
- (2) A and C only
- (3) A, B and D only
- (4) B, C and D only



11. The switches, bulbs and batteries used in the circuits below are similar. All the bulbs in the circuits light up.

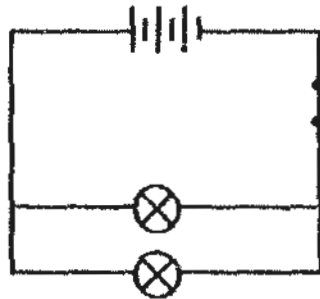

Circuit X

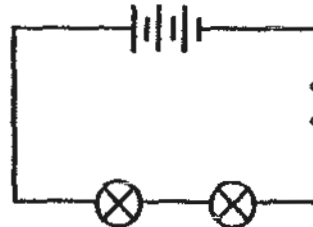

Circuit Y

Which of the following will be observed in the above circuits, X and Y?

- (1) Bulbs in Circuit X are brighter.
- (2) Bulbs in Circuit Y are brighter.
- (3) Bulbs in Circuit X will remain lit longer.
- (4) Bulbs in both circuits have the same brightness.

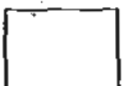

12. Andrew set up the circuit below. He added one battery at a time, in series, to the circuit below. And he measured the brightness of the bulb.

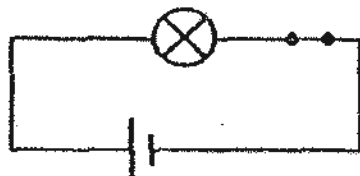

Circuit after 1 battery is added.

Which one of the following graphs shows correctly the relationship between the number of batteries added in series and the brightness of the bulb?

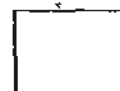
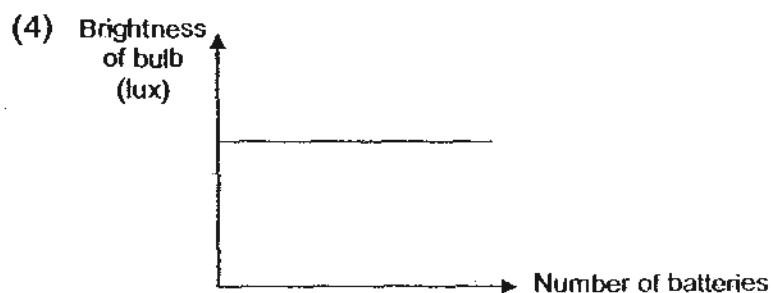
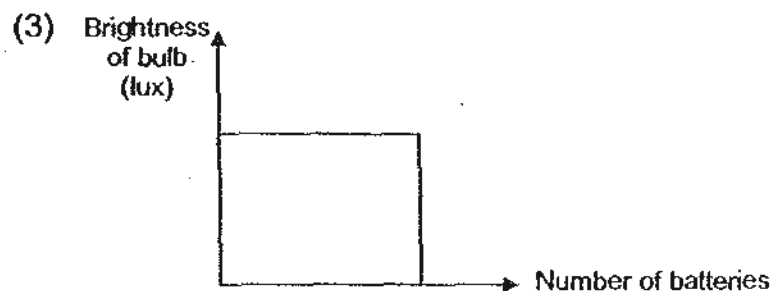
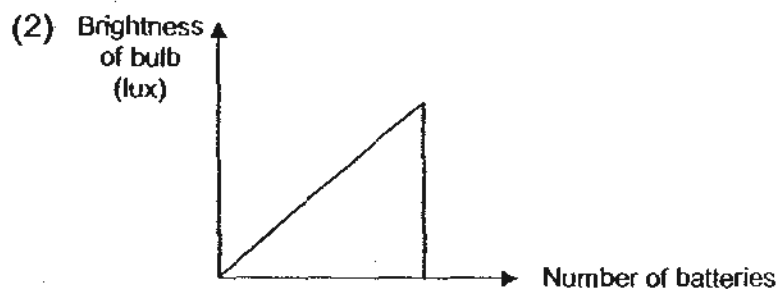
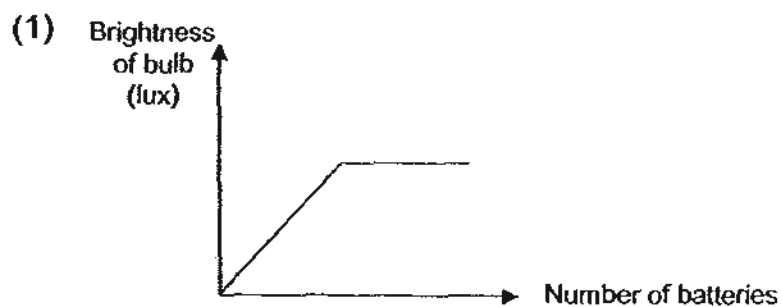

13. In the circuit shown below, the bulb lights up when connected to points A and C on the circuit card.

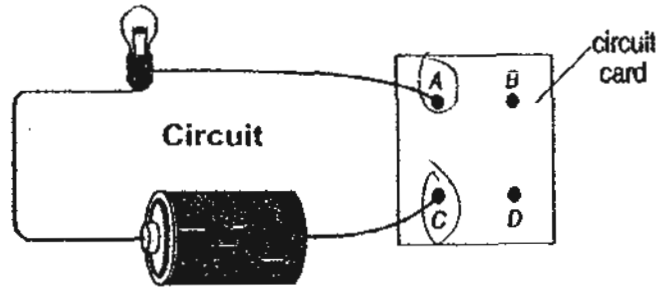

Which of the following diagrams shows how the wires are connected at the back of the circuit card?

(1)

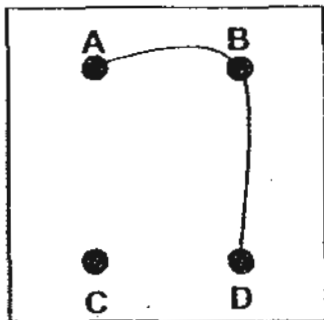

(2)

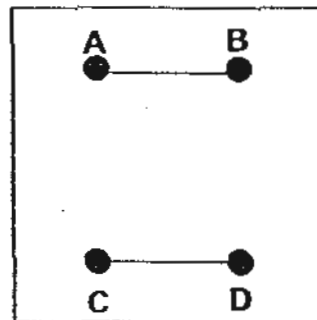

(3)

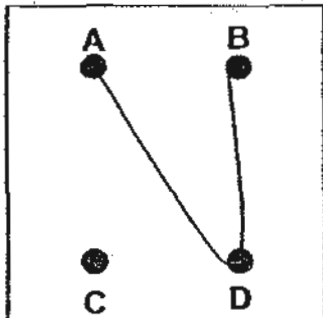

(4)

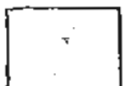
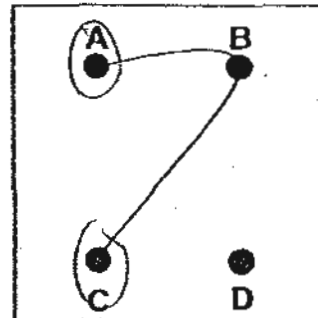

14. The diagram shows four lighted bulbs in a circuit. A switch is to be placed in the circuit so that only 2 bulbs can be switched off.

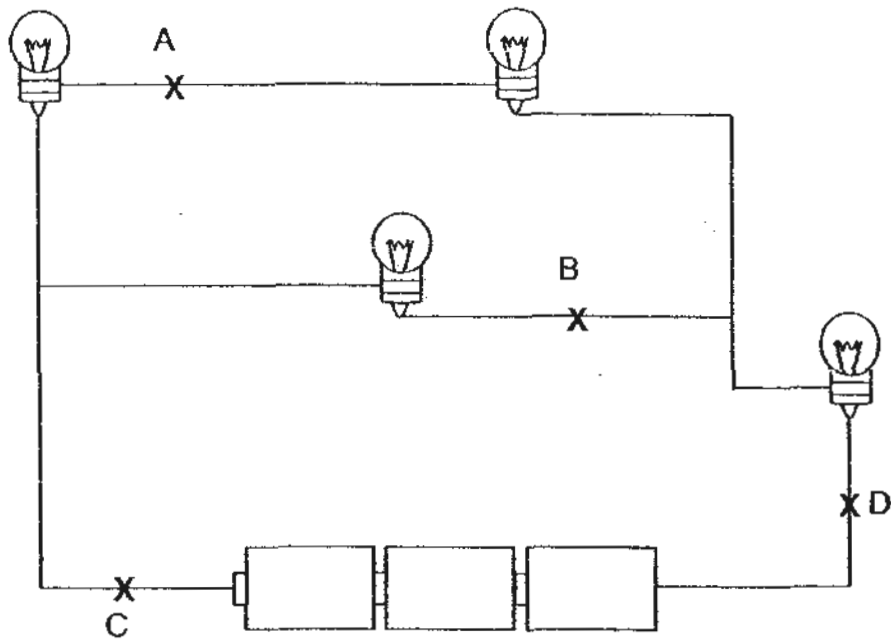

At which position, A, B, C or D, should the switch be placed?

- (1) A
- (2) B
- (3) C
- (4) D



15. A box is connected to a circuit tester. Some plastic and iron rings, connected in different ways, are placed in the box.

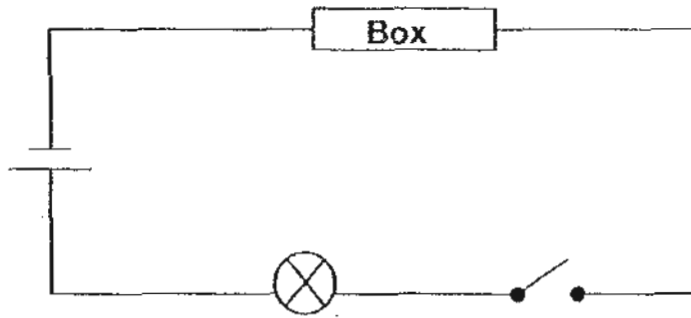

When the switch is closed, Mei Ling observed whether the bulb lights up. Which one of the following set of rings will cause the bulb to light up?

(1)

(2)

(3)

(4)

Plastic Ring	
Iron Ring	
Curved Wire	
Straight Wire	

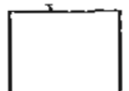

16. Krish set up the following circuits, A, B and C, shown below.

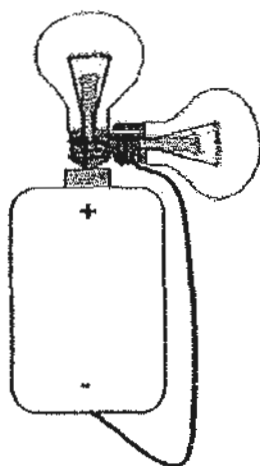

A

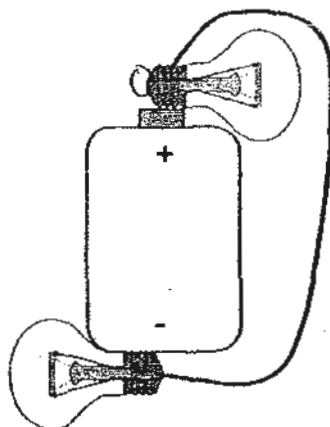

B

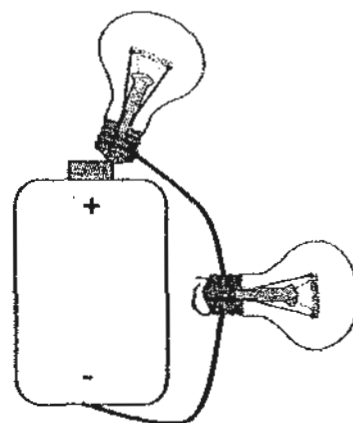

C

Which of the following will have 2 lighted bulbs?

- (1) A only
- (2) A and B only
- (3) A and C only
- (4) B and C only

17. Which one of the following does not help to conserve electricity?

- (1) Using energy-saving lamps.
- (2) Turning off the fans on a windy day.
- (3) Opening the refrigerator frequently.
- (4) Turning off the lights when leaving the room.



18. Extensive deforestation may result in changes in the composition of gases in the surrounding air.

Which one of the following correctly describes the changes that may occur in the surrounding air when large areas of forests are destroyed?

Gas in the surrounding air	
Oxygen	Carbon dioxide
(1) No change	Increase
(2) Increase	Decrease
(3) Decrease	Increase
(4) Decrease	No change

19. The drawing below shows a potted plant. A strong metal clip is placed across one of its stems. The plant is then placed in the garden and watered daily.

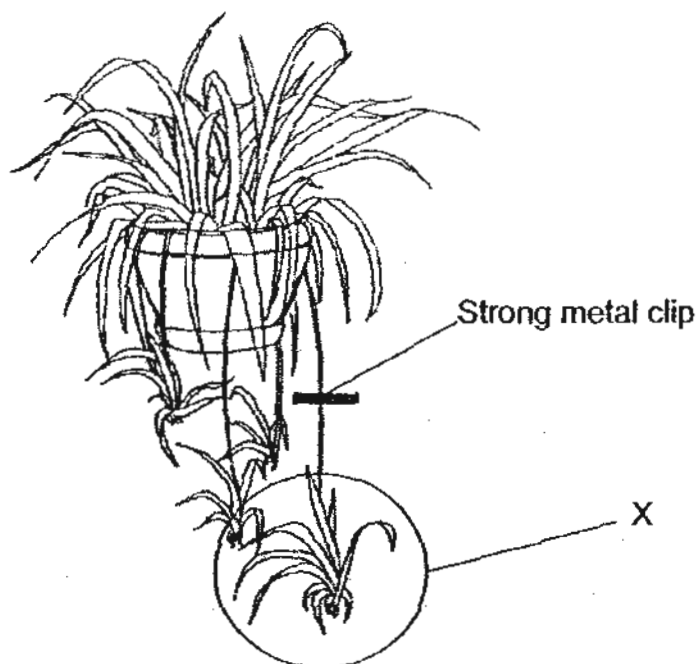

After 7 days, the leaves in X is observed to have shrivelled up. Which one of the statements below best explains this observation?

- A: Water cannot be transported to X.
B: Photosynthesis cannot take place in X.
C: Gaseous exchange cannot take place in X.

- (1) A only
(2) A and B only
(3) A and C only
(4) B and C only



20. The gills of a fish consist of feather-like gill filaments as shown below.

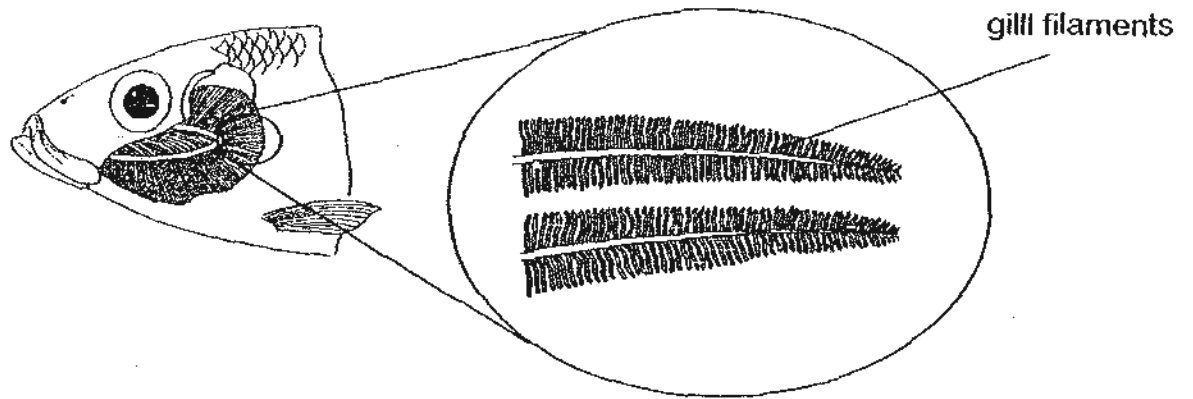

Which part of the human respiratory system performs a similar function as the gill filaments of a fish?

- (1) nose
- (2) air sacs
- (3) windpipe
- (4) diaphragm

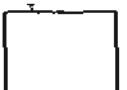

Study the graph below carefully and answer questions 21 and 22.
 Kim performed an activity for 45 minutes. The graph below shows the number of heartbeats per minute over the period of 45 minutes.

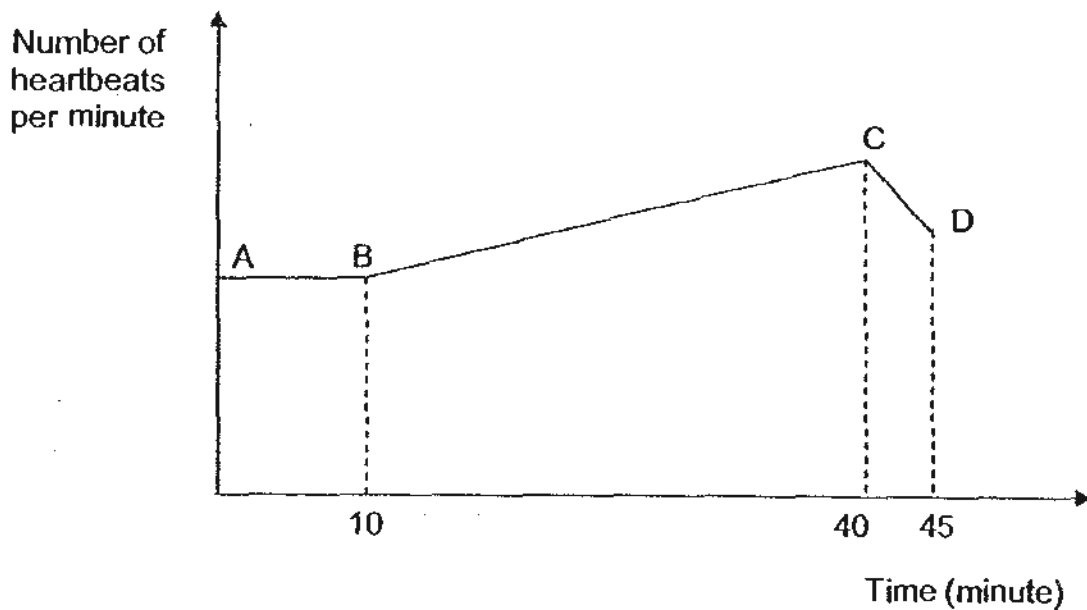

21. At which point A, B, C or D, on the graph did the amount of oxygen that was taken in by Kim's lungs ~~start to decrease~~?

- (1) A
- (2) B
- (3) C
- (4) D

22. Which of the following statement(s) below correctly describe(s) what is happening during the period indicated by the line BC on the graph?

- A: Kim's breathing rate is decreasing.
- B: Kim's body is producing more energy.
- C: Kim's body is producing less carbon dioxide.
- D: Kim's heart is pumping blood to her lungs at a faster rate.

- (1) B only
- (2) A and C only
- (3) B and D only
- (4) A, B and C only

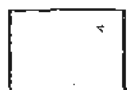

23. The chart below shows how organs in the digestive system are classified.

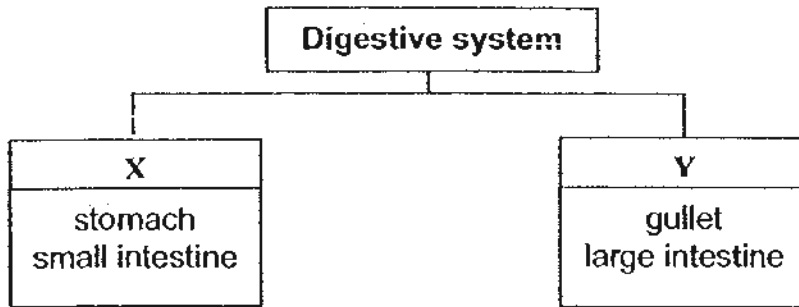

Which of the following are suitable headings to replace X and Y?

	X	Y
(1)	has muscles	does not have muscles
(2)	produces digestive juices	does not produce digestive juices
(3)	digested food is absorbed into blood stream	digested food is not absorbed into blood stream
(4)	stores digested food	transports undigested food



24. The diagram below shows Plants A and B.

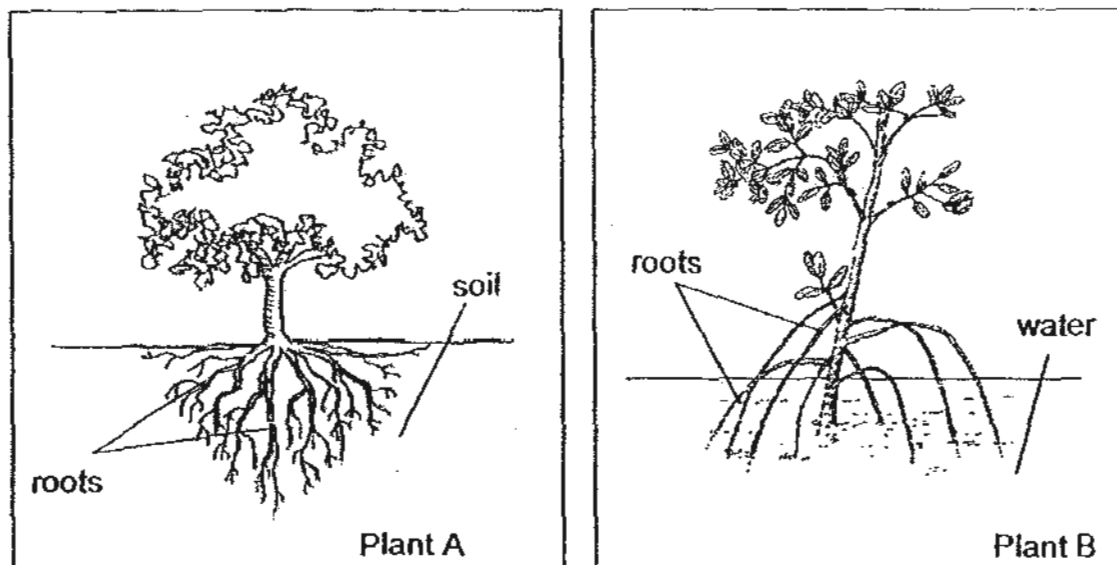

Which one of the following correctly describes the similarities between the roots of Plant A and Plant B?

- A: Both grow completely under the ground.
B: Both need oxygen.
C: Both take in water.
- (1) C only
(2) A and B only
(3) A and C only
(4) B and C only
25. As the embryo in the womb develops into a foetus (unborn baby), which of the statements about the development of the embryo is true?
- (1) The cells divide and also become larger.
(2) The cells divide and increase in numbers.
(3) The number of cells remains the same but grows larger.
(4) Smaller cells are replaced by larger cells as the foetus grows.



26. The diagram below shows Plant Y.

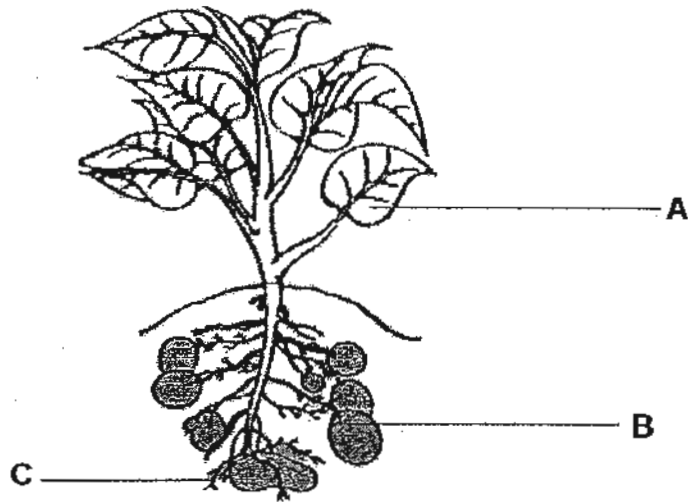

The diagram below shows one cell collected from Plant Y.

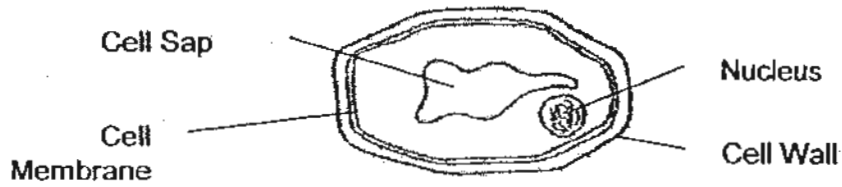

Which part of the plant (A, B or C) is this cell taken from?

- (1) A only
- (2) C only
- (3) A and B only
- (4) B and C only

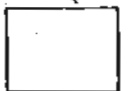

27. The cucumber plant produces both male and female flowers in the same plant.
 Charlie has 2 cucumber plants, Plant A and Plant B. He removed all male flowers from Plant A. He then removed all female flowers from Plant B. He placed both plants in his garden.

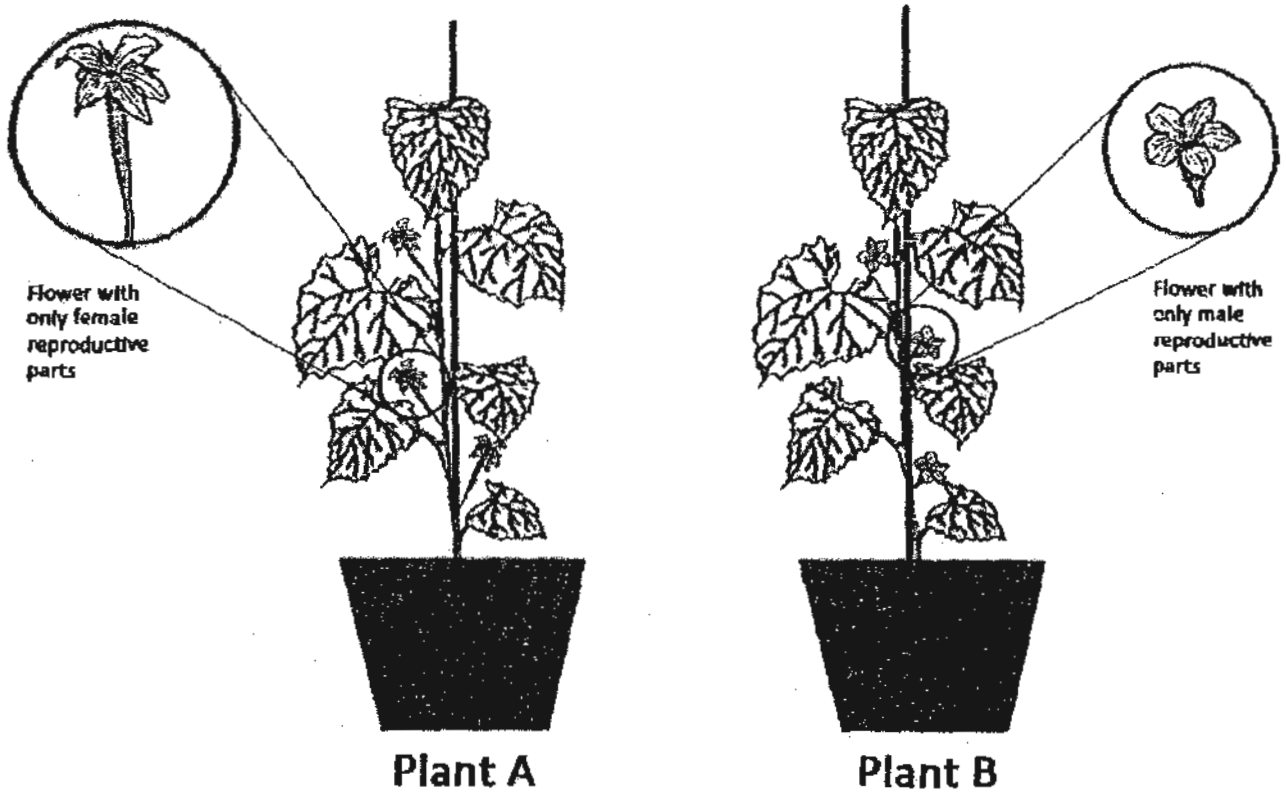

Identify the plant that is likely to produce cucumber fruits and the reason supporting your answer.

	Plant that produce cucumber fruits	Reason
(1)	Plant A	Plant A has female flowers that have bright petals.
(2)	Plant A	Plant A has female flowers that contain ovaries.
(3)	Plant B	Plant B has male flowers that contain pollen grains.
(4)	Plant B	Plant B has male flowers that contain the anthers.

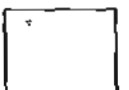

28. The diagram below shows the cross section of a cucumber fruit.

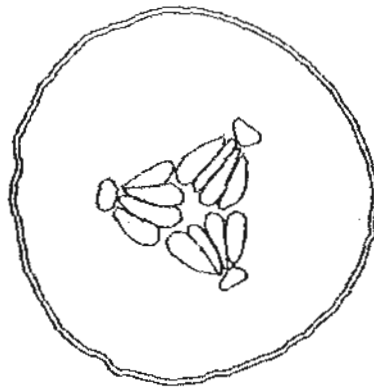

Which of the following diagram most accurately shows the cross section of a cucumber flower?

(1)



(3)

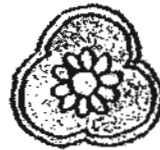

(2)



(4)

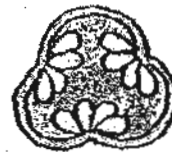

n7

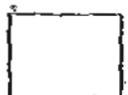

29. The following flowchart shows the characteristics of 4 different organisms, A, B, C and D.

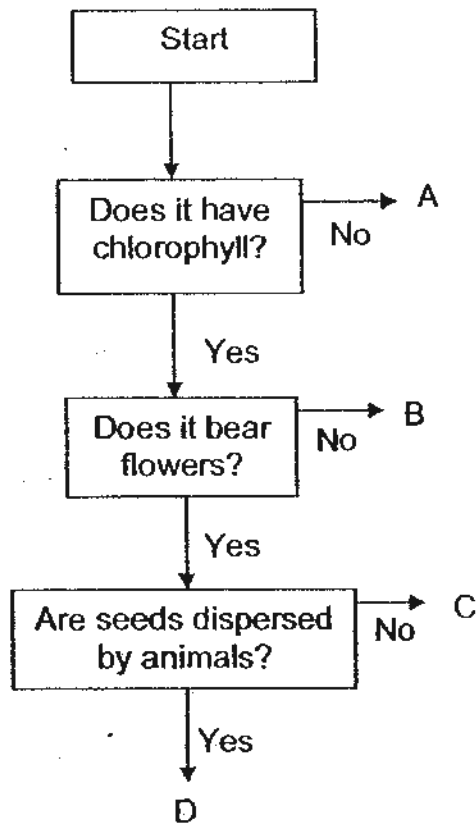

Which of the following are organisms A, B, C and D?

	A	B	C	D
(1)	Bird's Nest Fern	Bracket fungus	Balsam	Papaya
(2)	Mould	Bird's Nest Fern	Balsam	Coconut
(3)	Moss	Mould	Balsam	Bird's Nest Fern
(4)	Bracket fungus	Bird's Nest Fern	Lalliang	Tomato

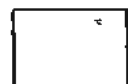

30. The diagrams below show the reproductive parts of a human and a plant.

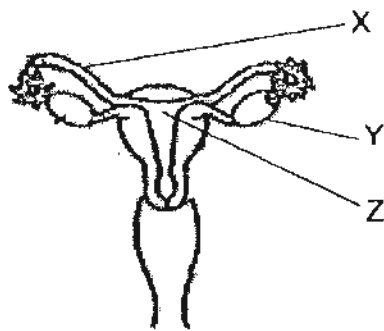

Reproductive part of a human

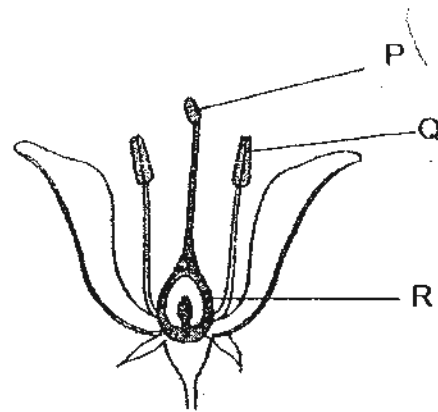

Reproductive part of a plant

Which one of the following statements about the reproductive parts of the human and the plant is ~~completely~~ true?

- (1) Parts Y and P store reproductive cells.
- (2) Fertilisation takes place at Parts X and P.
- (3) After fertilization, Part Z contains the developing baby while Part R develops into a fruit.
- (4) Parts X, Y and Z are female reproductive parts of humans, and parts P, Q and R are female reproductive parts of plants.

End of Part 1

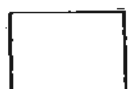



HENRY PARK PRIMARY SCHOOL
2010 SEMESTRAL EXAMINATION 2
PRIMARY 5 SCIENCE
Booklet B

Name: _____ ()

Class: Primary 5 _____

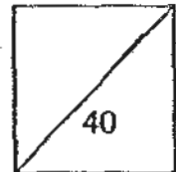

14 Questions
40 Marks

Total Time for Booklet A and B: 1 h 45 min

DO NOT OPEN THIS BOOKLET UNTIL YOU ARE TOLD TO DO SO.

READ AND FOLLOW INSTRUCTIONS CAREFULLY.

PART 2 (40 marks)

Write your answers to questions 31 to 44 in the spaces given.

31. Amy set up an experiment as shown below.

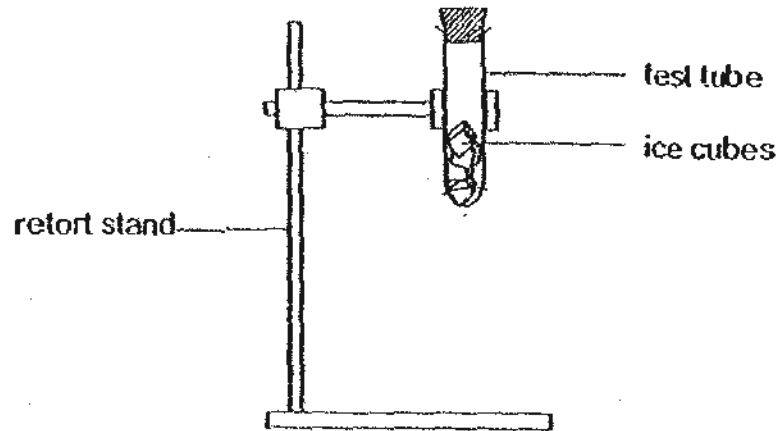

After a few minutes, Amy observed a substance forming on the outer bottom surface of the test tube.

a) Name the substance and explain clearly how it is formed. (2m)

b) Using the same set-up, Amy replaces the ice cubes with boiling water. Draw in the diagram below what Amy will observe. (1m)

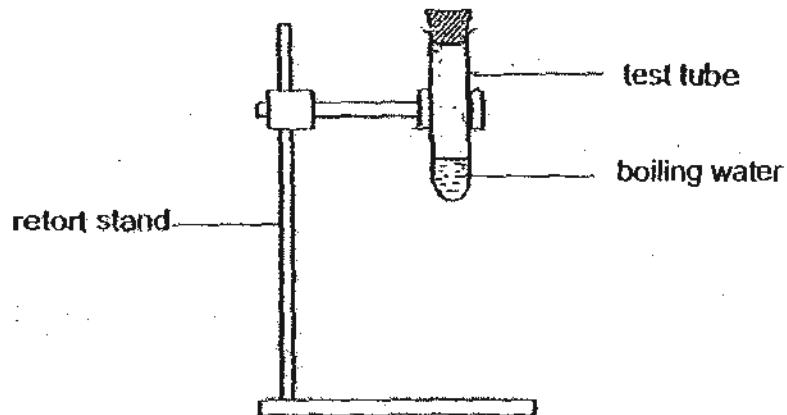

32. Ben wanted to find how fast the 2 different types of liquids, Y and Z, evaporate. He dropped 50 ml of Liquid Y using Set-up A and 50 ml of Liquid Z using Set-up B.

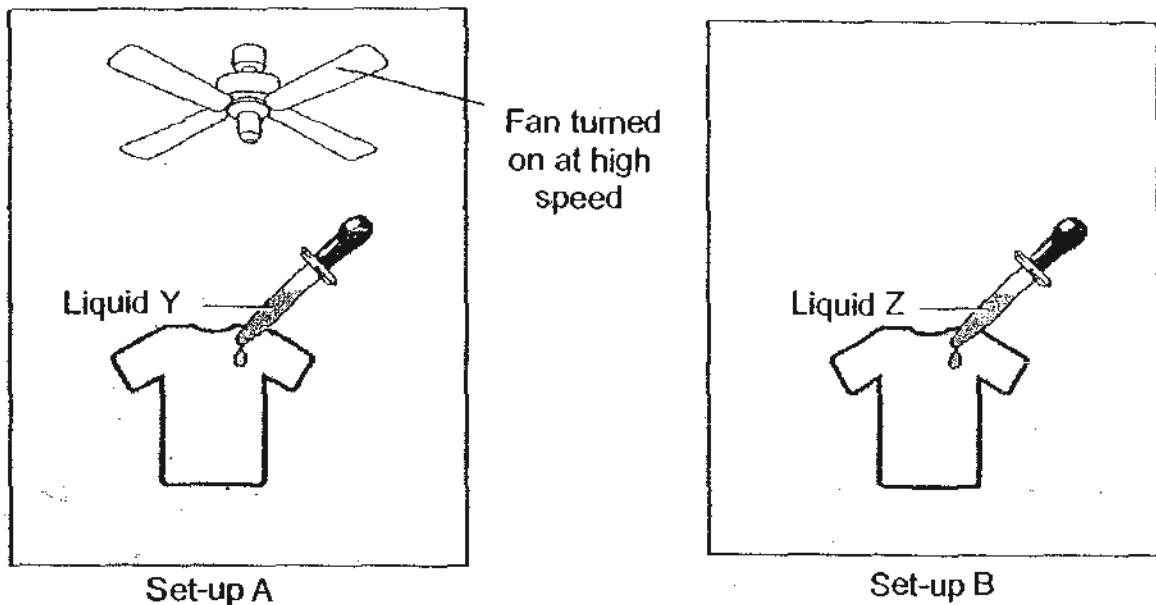

- (a) Explain clearly why his test was not a fair one.

(2m)

- (b) To arrive at a conclusion, Ben measured the time taken for the T-shirt to dry completely. Describe another way of measurement for Ben to arrive at the same conclusion.

(1m)



33. Ethan was given the following items to carry out an investigation on 2 rods, A and B. He has to find out which rod, A or B, is made of a material that conducts electricity. Only one of the rods conducts electricity.

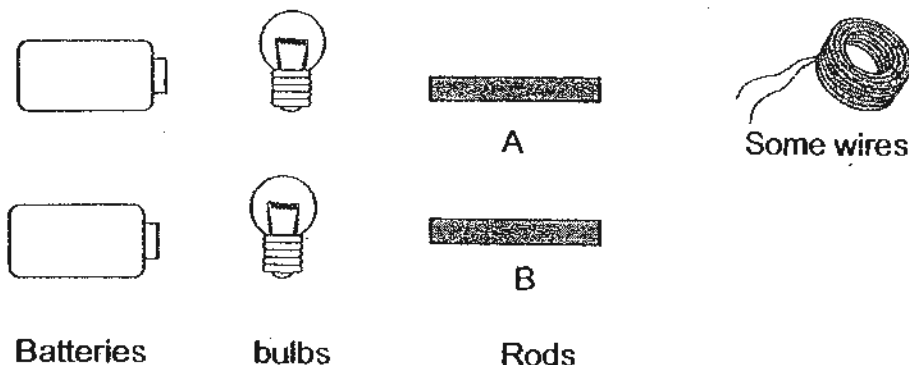

- (a) In the space provided below, draw one circuit diagram with all the given materials above to determine which rod, A or B, is an electrical conductor. Use appropriate symbols to represent the batteries and bulbs in your diagram. (2m)

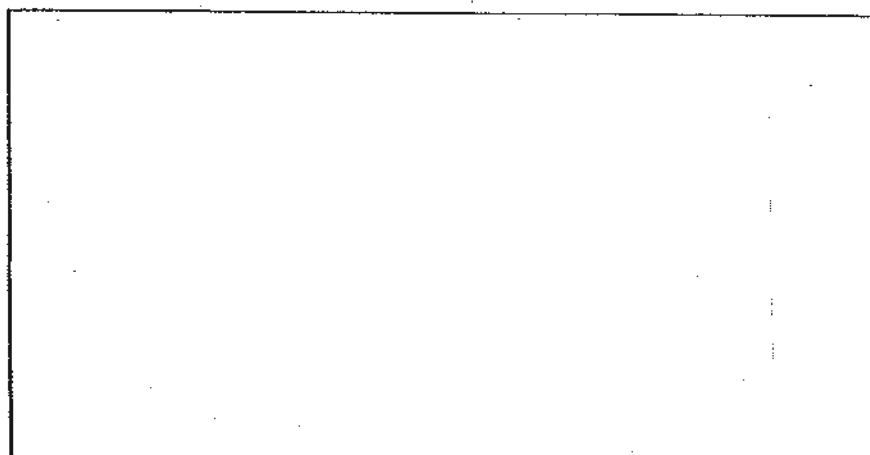

- (b) Based on the diagram drawn, explain how Ethan can conclude which rod is an electrical conductor. (1m)

34. Eliza installs a lamp over the stairway in her house as light is needed to climb the stairs shown below. She turns on the lamp using Switch A before climbing the stairs. Light is no longer needed once she reaches the top of the stairs.

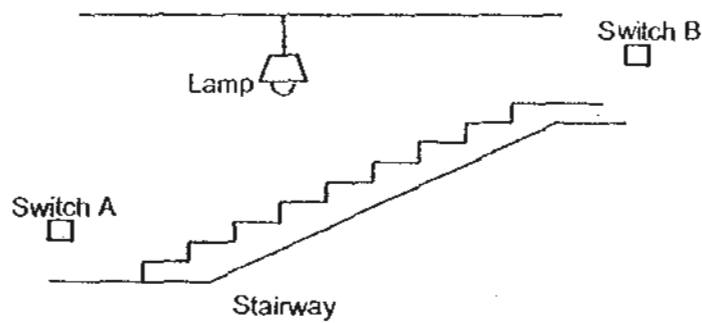

The diagram below shows the circuit before and after Eliza turns on Switch A at the bottom of the stairway. The switches A and B are connected to points 1, 2, 3 or 4 in the circuit.

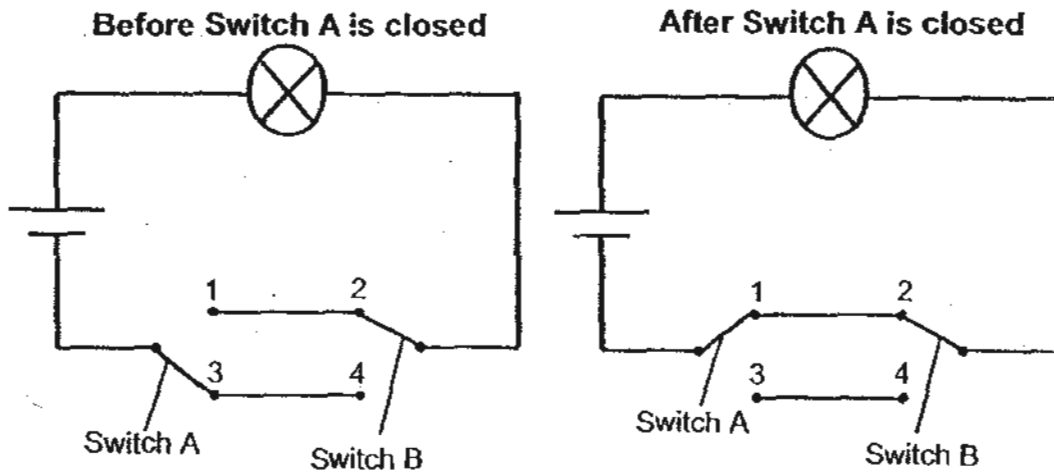

- (a) Complete the circuit diagram below to show how the circuit will appear after Eliza turns off the lamp from the top of the stairs. (1m)

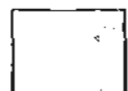
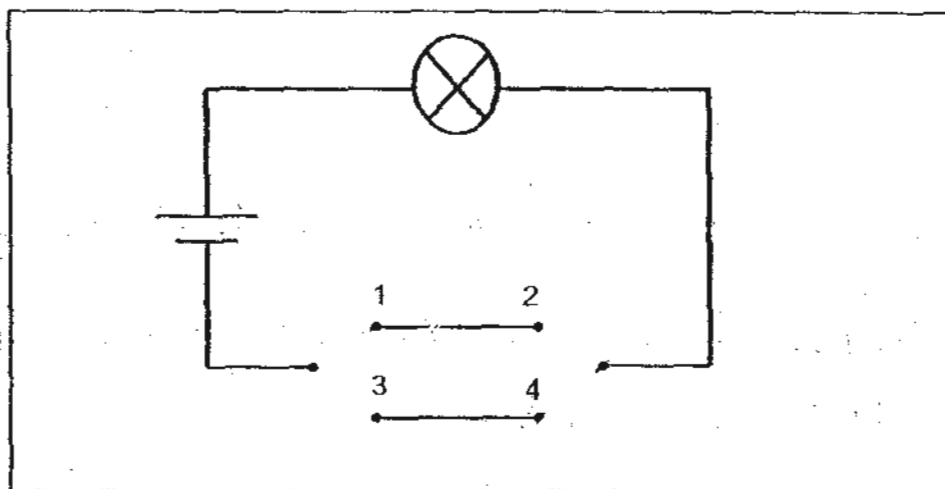

Question 34 (continued)

- (b) The circuit shown above is used to install the lamp at Eliza's stairway. State one advantage of using this circuit compared to a similar circuit that has only one switch.

(2m)

125



35. Jane set up the circuit tester as shown in the diagram below to test the electrical conductivity of the 3 materials, A, B or C.

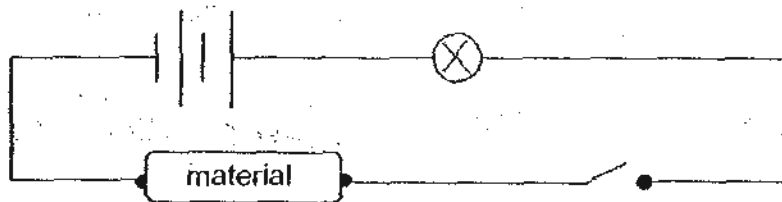

The results are shown in the table below.

Materials used in the circuit	Brightness of bulb
A	Dim
B	Bright
C	Bulb did not lit up

- (a) Based on the experiment above, compare the electrical conductivity of the 3 materials, A, B and C. (1m)

Study the diagram below.

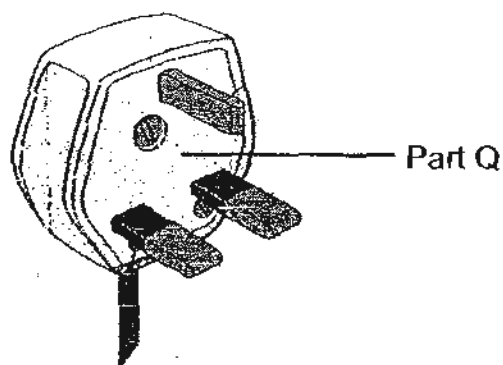

- (b) Which material (A, B or C) is most suitable for making Part Q of the plug? Give a reason for your answer. (1m)



36. Study the circuit below.

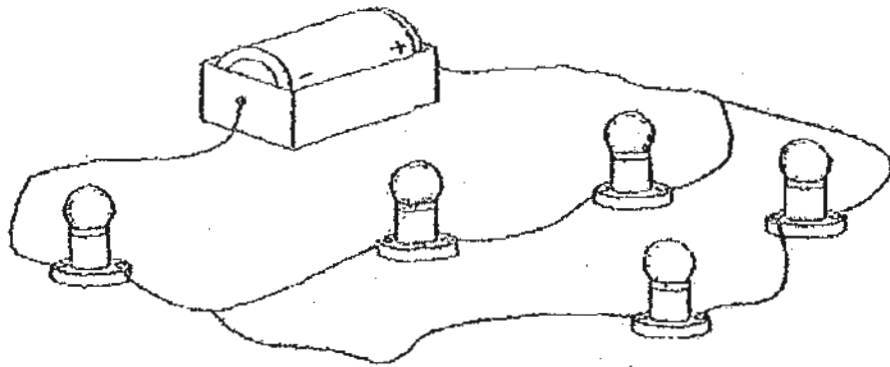

In the space provided, draw a circuit diagram of the above set up.

(2m)

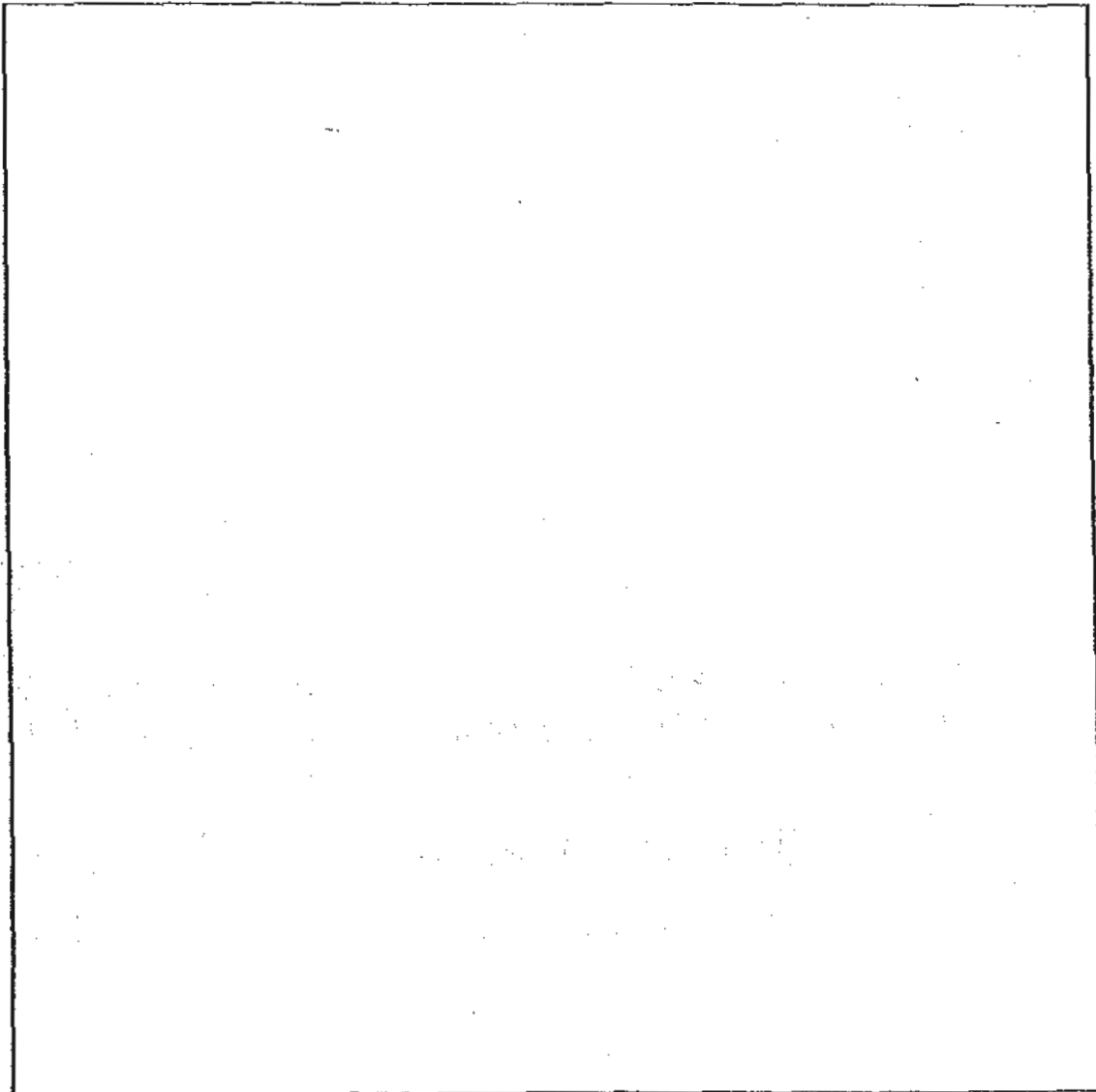

Sam set up a circuit as shown below to find out how the arrangement of bulbs affects the brightness of the bulbs in a closed circuit.

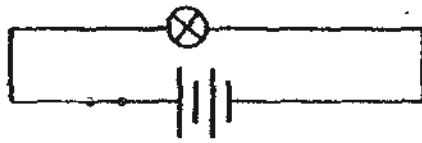

A



B

Each circuit at the start of the experiment

Steps:

1. Sam adds one bulb to each circuit.
2. Then he observes the brightness of the bulbs in each circuit.
3. He adds another bulb to each circuit.
4. Then he observes the brightness of the bulbs in each circuit.

The results are shown in the graph below.

Amt of brightness

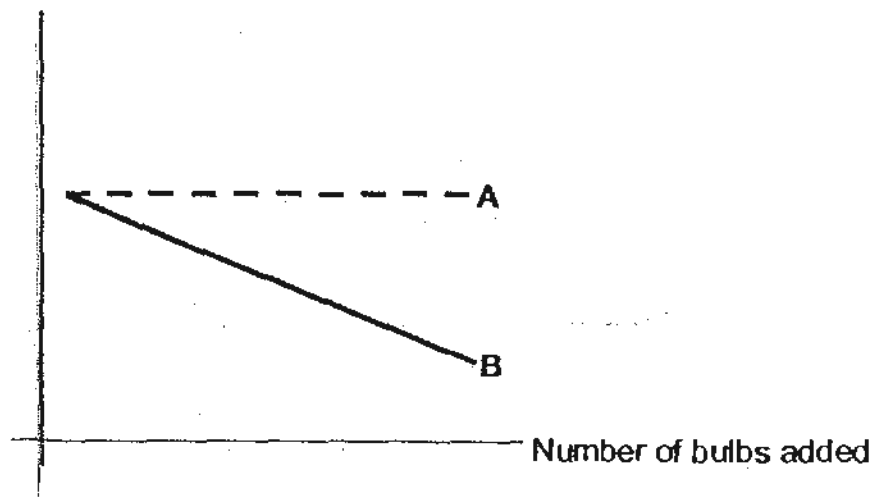

- (a) Explain the difference in the results shown in the graph.

(2m)

- (b) What will happen to bulbs in each circuit when one bulb in each circuit blows?

(1m)

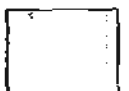

38. Zhiwei was driving his car along a road without street lamps at night. Luckily, he could still see his way using the reflective stripes on the road along the way.

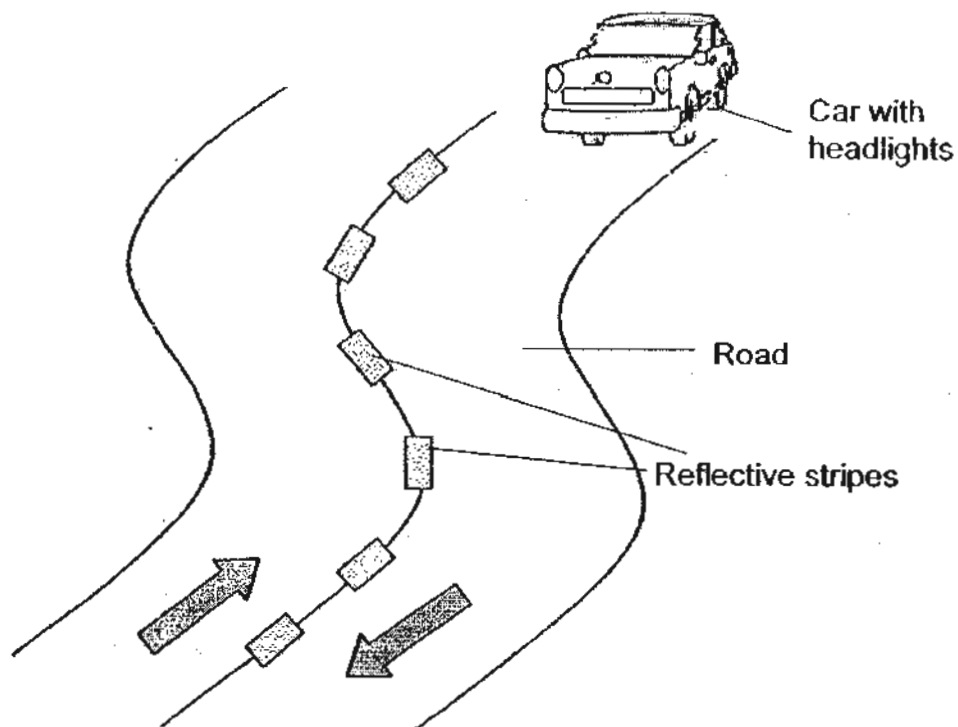

- (a) What is the main source of light for Zhiwei to see the reflective stripes on the road? (1 m)

- (b) Explain how Zhiwei is able to see the reflective stripes. (1m)

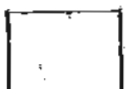

39. Michael wanted to find out if overcrowding would affect the growth of a plant. He carried out the following steps in his experiment.

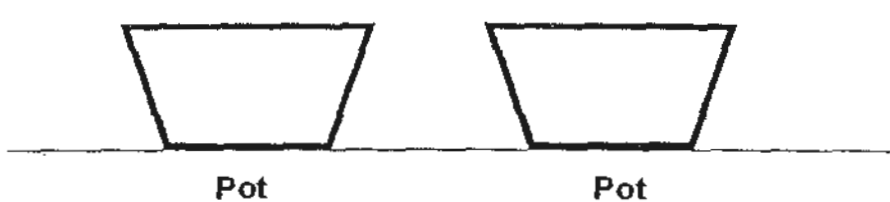
Step 1	<p>Get 2 identical pots and fill them with the same amount of soil.</p> 
Step 2	<p>Place 3 red bean seeds in Pot X and place 15 red bean seeds in Pot Y.</p>
Step 3	<p>Place both pots in a balcony where it is bright.</p>
Step 4	<p>Measure and record the height of the plants in both pots every day for 2 weeks, and calculate the average height of plants in each pot.</p>

At the end of two weeks, Michael found out that his experiment did not work. He had left out an important step after Step 3.

- (a) Based on the conditions for seeds to germinate, and about controlled variables, write down the important step that Michael had left out after step 3.

(2m)

- (b) Identify the test variable and the measured variable in the above experiment.

(1m)

(i) Test Variable: _____

(ii) Measured Variable: _____



40. Study Betty's family tree below.

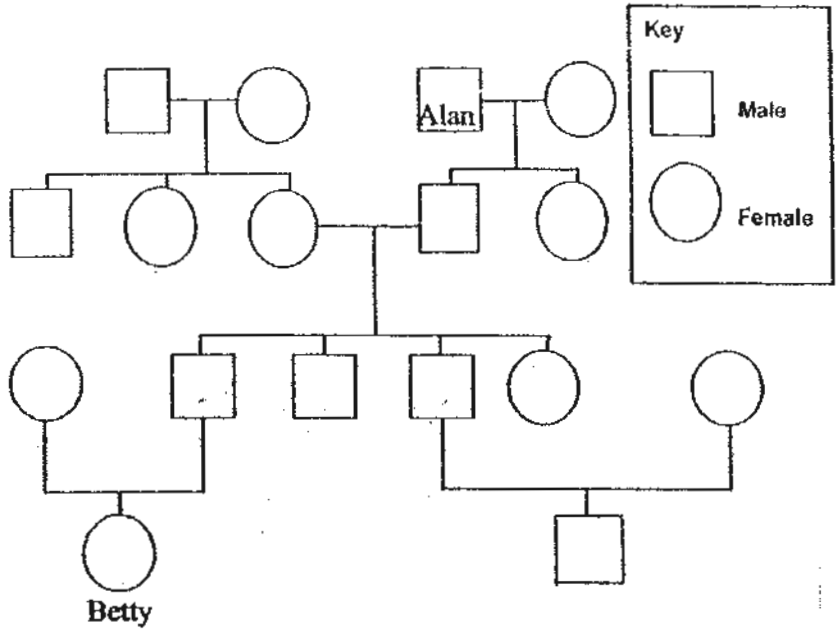

(a) Shade the box or circle in the above diagram that represents Betty's cousin. (1m)

(b) Alan has a trait 'Z'. This trait is passed down from generation to generation and it affects only males. Other than Alan, how many male(s) in this family tree have trait 'Z'? (1m)

(c) Put a tick (✓) in the correct box for each statement. (1m)

	Statement	True	False	Not possible to tell
(i)	Betty's father is the eldest child in the family.			
(ii)	4 generations are represented in the family tree.			

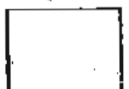

41. Dolly was studying a specimen of the unicellular Organism X, shown in the diagram below. Organism X is found in ponds and moves with the use of its tail-like structure or flagellum.

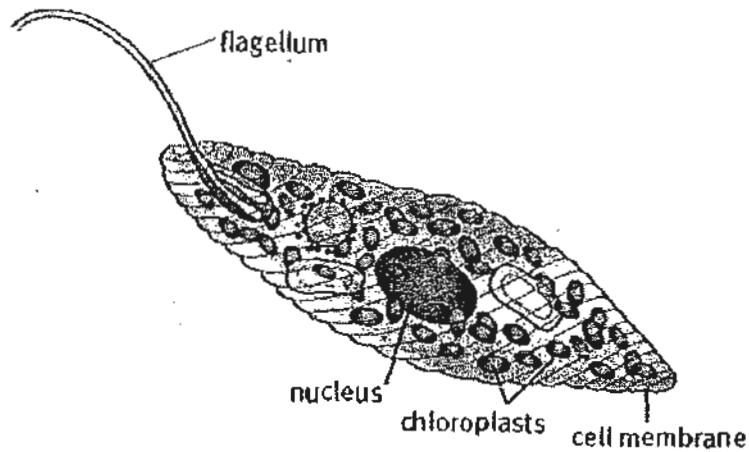

- (a) Based on the diagram, explain why Dolly would have difficulty classifying Organism X as an animal or plant cell.

(1m)

The diagram below shows Cell Y, a male reproductive cell. When introduced into the female reproductive system, it needs to move towards the egg cell to fertilize it.



- (b) Based on the information from part (a), explain how Cell Y moves.

(1m)



Question 41 (continued)

- (c) Wen Shi has not been watering her plant for a few days and observed the following.

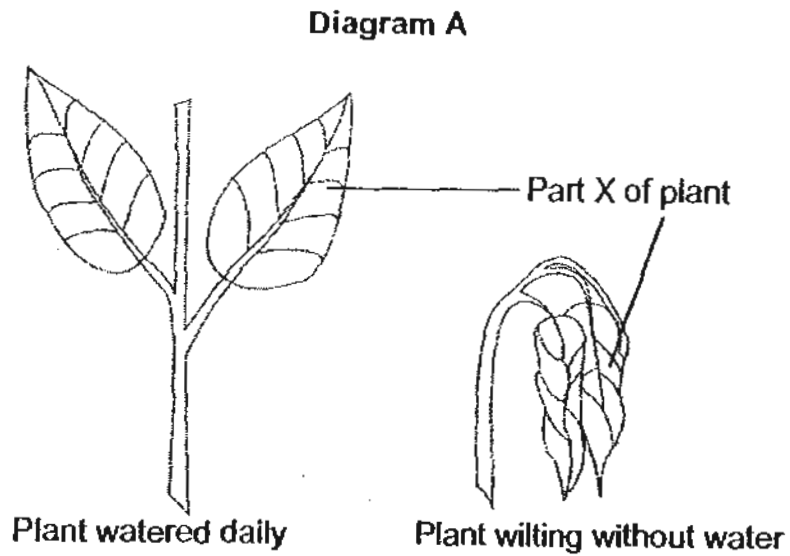

Cells, P and Q, are obtained from Part X of the plant.

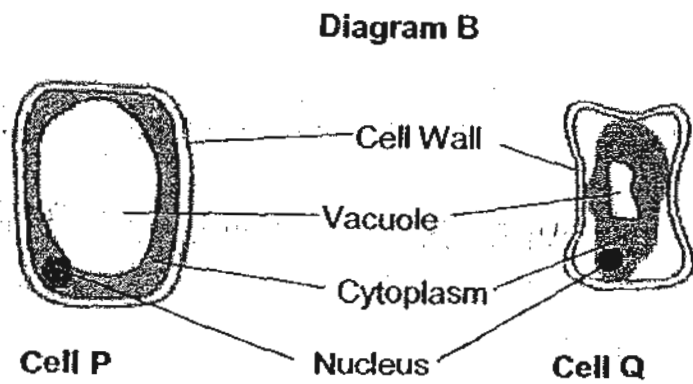

- (i) Which cell, P or Q, is obtained from the wilting plant? Give a reason for your answer. (1m)

- (ii) Which part of the cell contains the most water? Using evidence from the diagrams above, explain your answer. (1m)

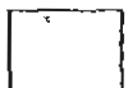

- 42 The diagram below shows what happens before and after a cell is placed in a container filled with Substances X and Y.

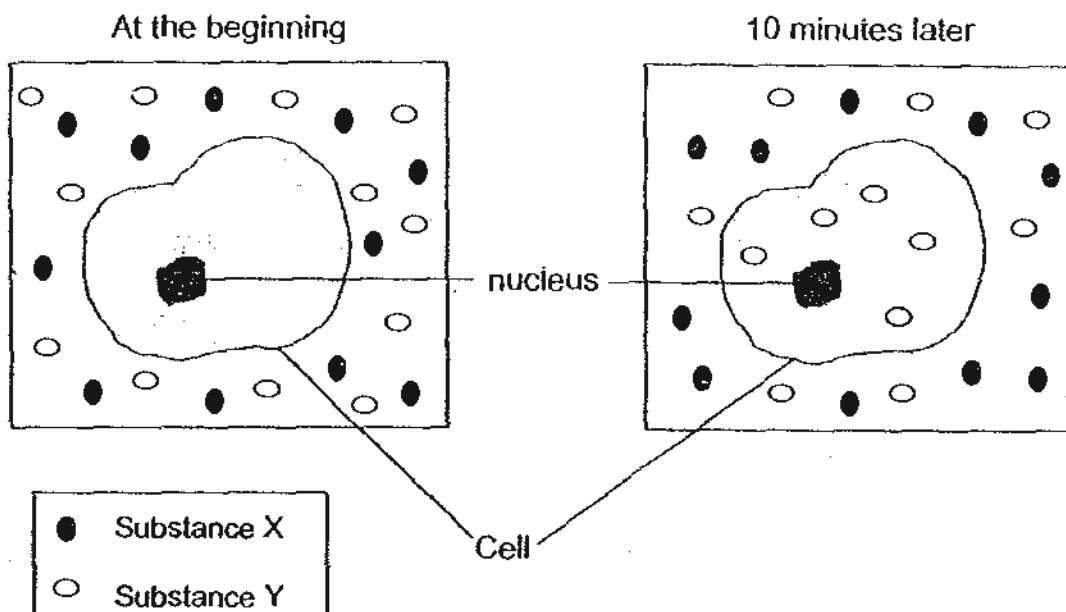

- (a) What has happened to the cell 10 minutes after it is placed with Substances X and Y?

(1m)

- (b) Which part of the cell is responsible for this change? Give a reason for your answer.

(1m)



- 43 (a) The diagram below illustrates how gases flow in the human respiratory system. The white arrow A and the black arrow B represent the direction of flow of the gases.

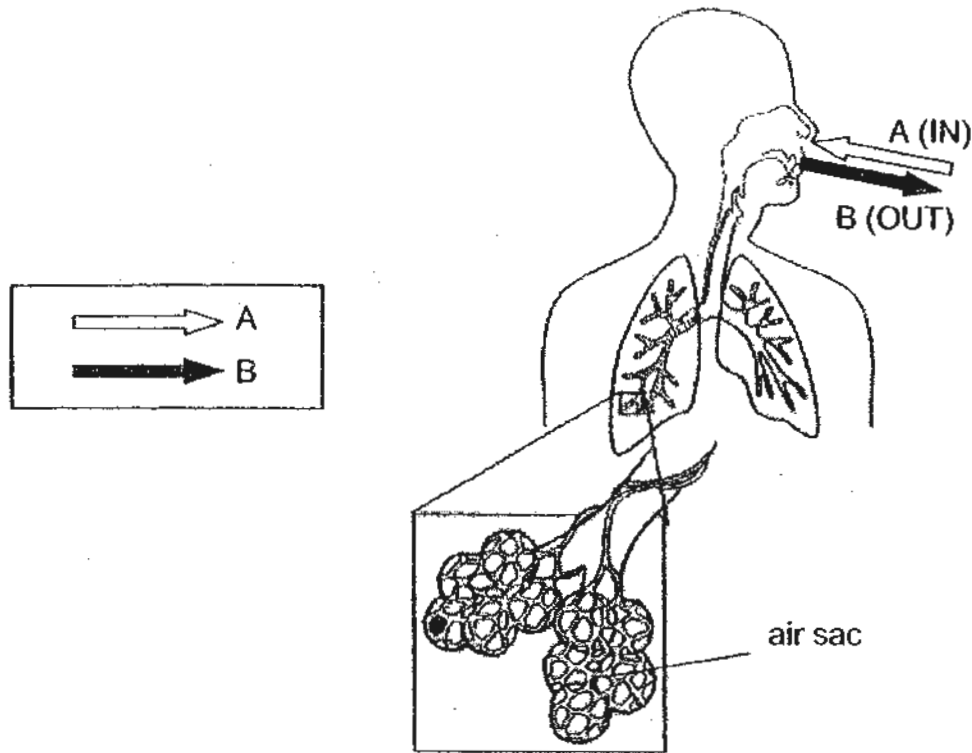

- (i) State one difference in the air that flow in the direction of A compared to B. (1m)

- (ii) The lungs of the human respiratory system are made up of many air sacs. State one similarity in the function of the air sacs in the human lungs and the function of the stomata of a plant. (1m)

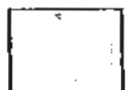

Question 43 (continued)

(b) The diagram below represents the human circulatory system. Arrows W, X, Y and Z show the direction of flow of blood in the blood vessels. P and Q represent parts of the body.

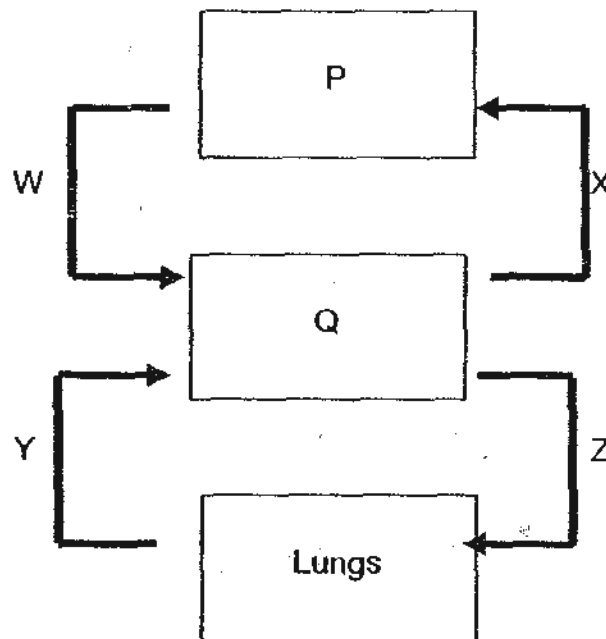

(i) Which blood vessel(s) W, X, Y or Z, contain(s) blood richer in oxygen? (1m)

(ii) Explain your answer in (i). (1m)

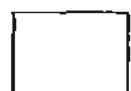

44. The set-ups below are prepared to find out the effects of pollutants (oil and soot) on plants. Three similar pots of plants P, Q and R are placed in the same location in a garden and watered daily with the same amount of water.

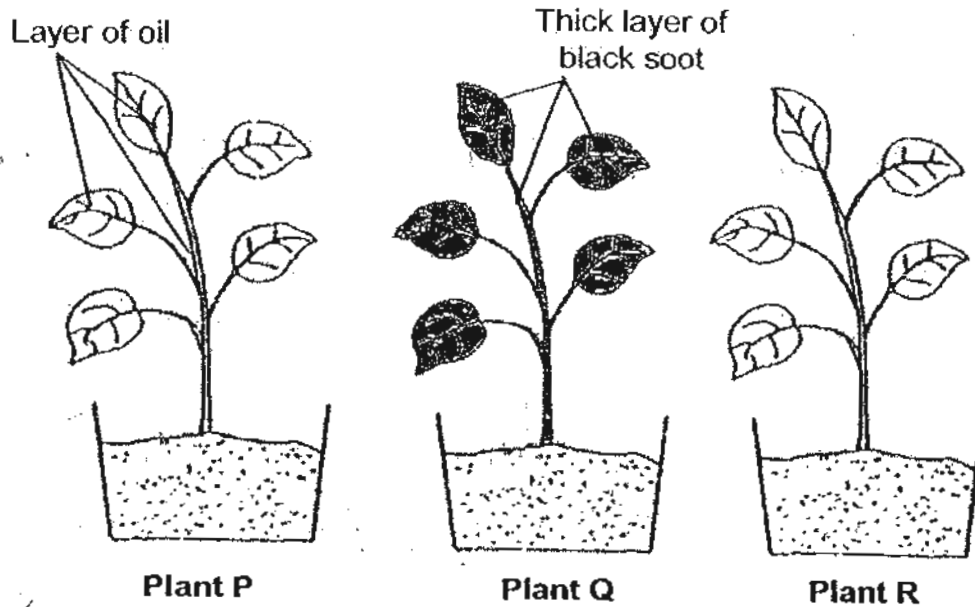

All leaves and stems were covered with oil for Plant P and soot for Plant Q. (Soot is a fine black powder which can be found in exhaust pipes or a burning candle).

The bar chart below shows the number of green leaves observed in each plant over a period of five days.

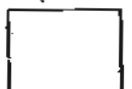
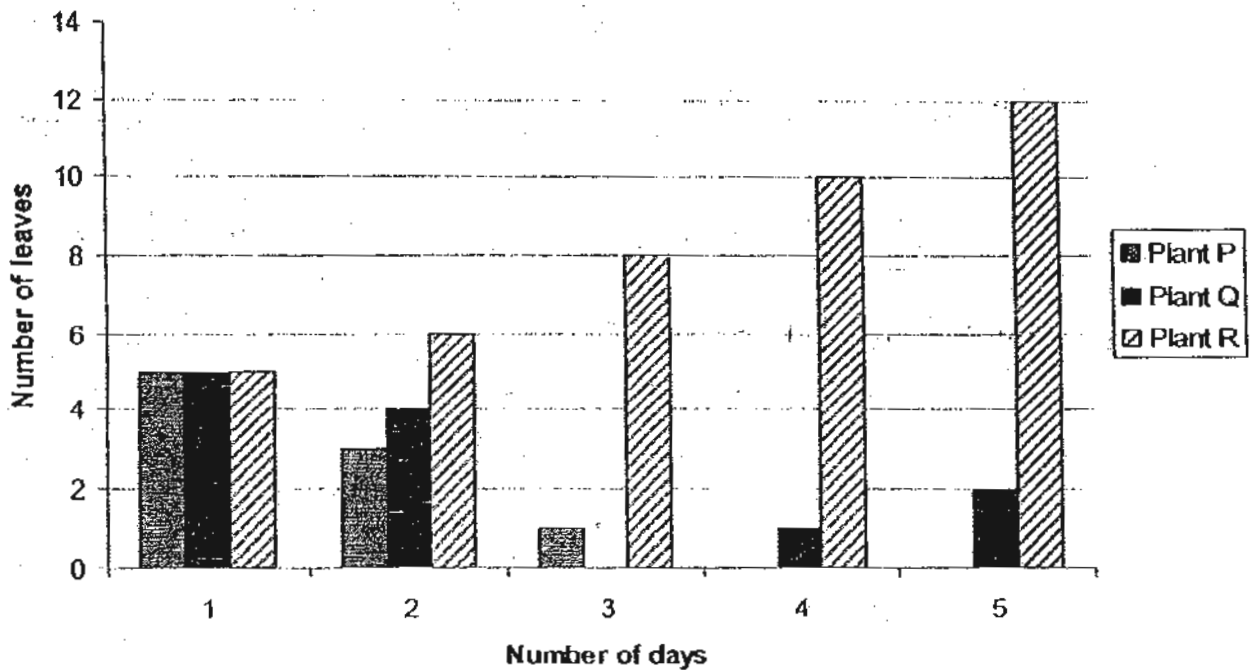

Question 44 (continued)

- a) Based on the data in the bar chart, describe the effects of oil on Plant P. (1m)

- b) Which pollutant (oil or soot) was less harmful to the plant? Use information in the question to support your answer. (1m)

- c) Explain the purpose of Plant R in this experiment. (1m)



ANSWER SHEET

EXAM PAPER 2010

SCHOOL : HENRY PARK PRIMARY

SUBJECT : PRIMARY 5 SCIENCE

TERM : SA2

Q1	Q2	Q3	Q4	Q5	Q6	Q7	Q8	Q9	Q10	Q11	Q12	Q13	Q14	Q15	Q16	Q17
4	2	4	4	1	2	4	3	2	3	1	2	4	1	3	1	3

Q18	Q19	Q20	Q21	Q22	Q23	Q24	Q25	Q26	Q27	Q28	Q29	Q30
3	2	2	3	3	2	4	2	4	2	4	4	3

31a) Water droplets. The water vapour from the surrounding air comes into contact with the cooler surface of the test tube and condensed to form water droplets.

31b)

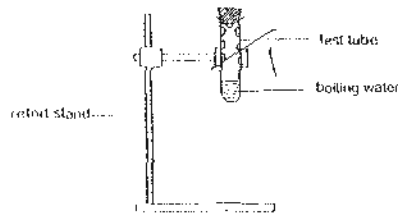

32a) Only the type of liquid should be changed. Changing the amount of wind would also cause changes in the rate of evaporation.

32b) Measure the mass of the t-shirt after a fixed period of time / at the end of the experiment.

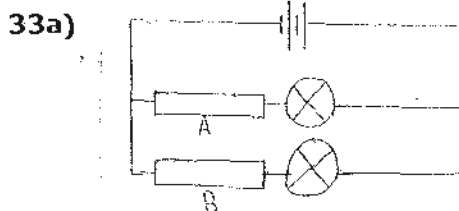

33b) Observe which bulb next to the rods lights up, the bulb which lights up shows that the rod is a conductor of electricity.

34a)

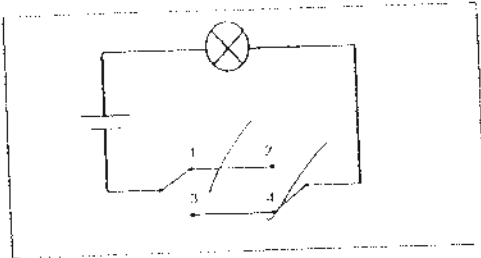

34b) You are able to control the lamp whether you want it to light up or not at different places and electricity can be conserved. Whereas, a similar circuit that has only one switch will only allow you to control the lamp whether you want it to light up or not at only one place.

35a) B conducts the most electricity while A conducts a little electricity and C does not conduct electricity.

35b) Material C. Material C is an insulator of electricity, hence, when we touch Part Q, we will not get electrocuted.

36)

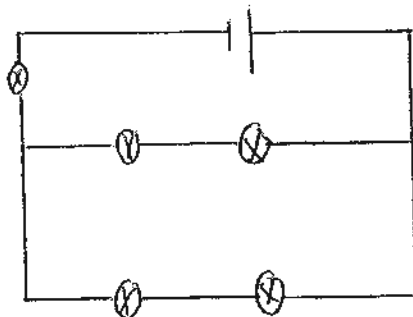

37a) Bulbs in A are arranged in parallel so when more bulbs are added, brightness is still the same. Bulbs in B are arranged in series so when more bulbs are added, brightness decreases.

37b) The rest of the bulbs in circuit A will still light up while all the bulbs in circuit B will not light up.

38a) The headlights of his car.

38b) Light from the headlights is reflected off the reflective stripes into Zhiwei's eyes.

39a) He should put it in a cupboard and water both pots daily with equal amounts of water as seeds need oxygen, water and warmth to germinate.

39bi) Number of red beans in each pot

39bii) Height/Average height of plants.

40a)

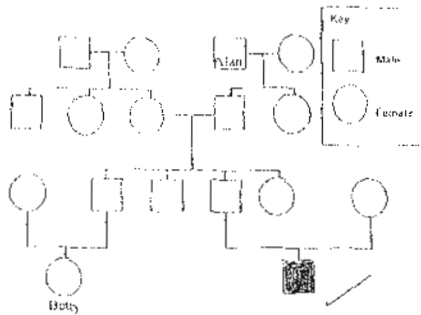

40b) 5 males in this family tree have trait 'Z'.

40c)

(c) Put a tick (✓) in the correct box for each statement.

	Statement	True	False	Not possible to tell
(i)	Betty's father is the eldest child in the family			✓
(ii)	4 generations are represented in the family tree	✓		

41a) Plant cells have cell wall, but X has no cell wall. Animal cells have no chloroplasts but X has chloroplasts.

41b) It moves using its tail-like structure or flagellum.

41ci) Cell Q. Parts of the cell/vacuole/cytoplasm/ cell wall of Cell Q is shriveled up, which meant that it is lack of water, hence, it is obtained from the wilting plant which had a lack of water.

41cii) The vacuole. In Cell P, the vacuole expands and thus, it has water. But in Cell Q, it shrinks most and shriveled up, which meant that there was not enough water.

42a) Some of the Substance Y was found in the cell but none of substance X was found in the cell.

42b) The cell membrane. The cell membrane is partially-permeable. It controls substance moving in and out of the cell. Hence, it is responsible for this change.

43ai) Air that flow in the direction of A is cooler than air that is flown in the direction of B.

43aii) Gaseous exchange is carried out in the air sacs and the stomata of a plant.

43bi) Blood vessel Y and X.

43bii) The lungs contain rich- blood in oxygen as oxygen is being inhaled and travels to the lungs. Blood in X and Y comes from the lungs where oxygen is absorbed.

44a) Plant P lost all its leaves on day 4/after day 3.

44b) Soot. Plant Q grew one new leaf on day 4.

44c) To provide the basis for comparison to prove that the change/result is due entirely to the test variables.