

Anglo-Chinese School
(Junior)



SEMESTRAL ASSESSMENT 1 (2011)
PRIMARY 4

MATHEMATICS

Booklet A

Thursday

12th May 2011

1hr 45 min

INSTRUCTIONS TO PUPILS

DO NOT TURN OVER THE PAGES UNTIL YOU ARE TOLD TO DO SO.

Follow all instructions carefully.

There are 20 questions in this booklet.

Answer ALL questions.

Name:..... ()

Class:.....

Section	Possible Marks	Marks Obtained
A	40	

Parent's Signature : _____

This question paper consists of 9 printed pages. (Inclusive of cover page)

Section A (20 × 2 marks)

For each question, four options are given. Choose the correct answer and shade the correct oval (1, 2, 3 or 4) on the Optical Answer Sheet provided.

1. In 6 472, the digit 4 is in the _____ place.

- (1) ones
- (2) tens
- (3) hundreds
- (4) thousands

2. What is the sum of the fourth and sixth multiples of 8?

- (1) 24
- (2) 32
- (3) 48
- (4) 80

3. Which one of the following statements is **incorrect**?

- (1) 4 is a common factor of 12 and 48
- (2) 2 is a common factor of 18 and 36
- (3) 3 is a common factor of 27 and 33
- (4) 6 is a common factor of 26 and 42

4. What is the missing number digit in the box?

$$\begin{array}{r} 23\boxed{4} \\ \times \quad 3 \\ \hline 7182 \end{array}$$

- (1) 6
- (2) 7
- (3) 8
- (4) 9

5. What is the quotient when 7644 is divided by 6?

- (1) 1027
- (2) 1074
- (3) 1274
- (4) 1277

6. Express $2\frac{8}{24}$ in its simplest form

- (1) $\frac{1}{3}$
- (2) $\frac{56}{24}$
- (3) $2\frac{1}{3}$
- (4) $2\frac{4}{12}$

7. Write an improper fraction for the shaded parts.

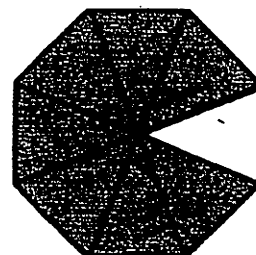
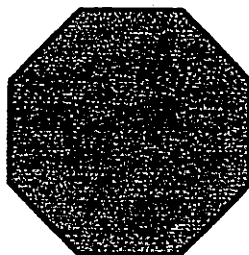
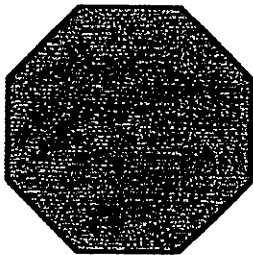

- (1) $\frac{9}{8}$
- (2) $\frac{16}{8}$
- (3) $\frac{23}{8}$
- (4) $\frac{24}{8}$

8. Find the value of $2 - \frac{3}{4} - \frac{1}{6}$.

(1) $\frac{1}{12}$

(2) $\frac{11}{12}$

(3) $1\frac{1}{12}$

(4) $1\frac{11}{12}$

9. John had 36 stickers. He gave $\frac{1}{3}$ of the stickers to his friends. How many stickers does he have left?

(1) 12

(2) 24

(3) 34

(4) 48

10. Given the following: $1 + \frac{3}{10} = 1\frac{3}{5} - \frac{\square}{10}$

What is the missing number in the box?

(1) 5

(2) 10

(3) 3

(4) 18

The following graph shows the number of tickets sold for Junior Superstar to the boys. Study the graph carefully and answer questions 11 and 12.

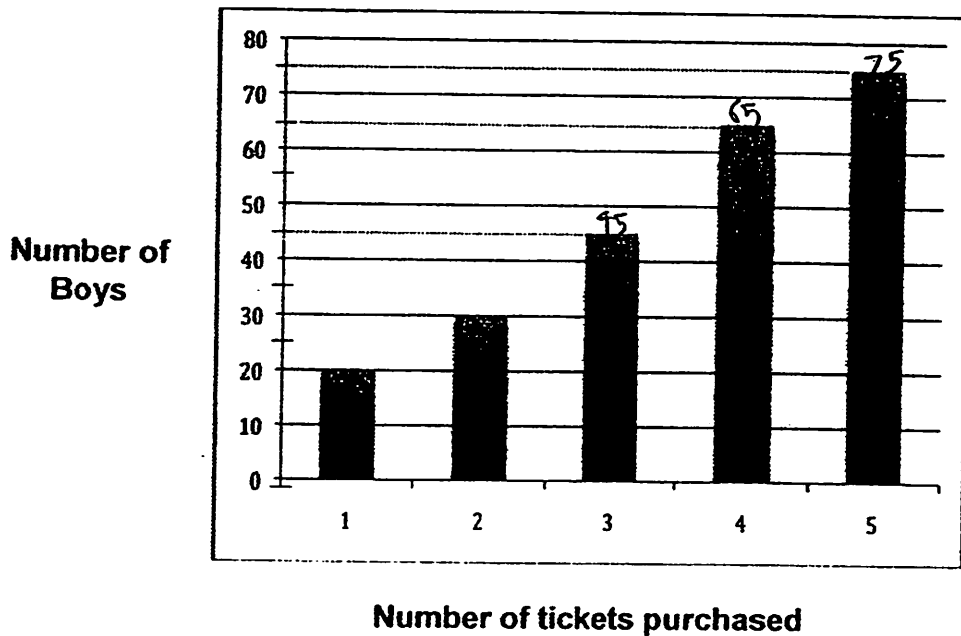

11. How many boys purchased more than 2 tickets?

- (1) 12
- (2) 30
- (3) 185
- (4) 215

12. If each ticket cost \$2.00, how much money was collected from the boys who bought only 5 tickets?

- (1) \$ 150
- (2) \$ 260
- (3) \$ 375
- (4) \$ 750

The table below shows the favourite rides taken by three classes at a theme park. Study the table below carefully and answer questions 13 and 14.

Class	Superman	Battle Star	Spider Ride	Ninja Twist
Primary 6A	2	20	9	10
Primary 6B	6	?	14	21
Primary 6C	4	23	6	8
Total	12	57	29	39

13. How many pupils in 6B chose "Battle Star" as their favourite ride?

- (1) 14
- (2) 20
- (3) 23
- (4) 43

14. Which was the 2nd most popular ride among the three classes?

- (1) Superman
- (2) Battle Star
- (3) Spider Ride
- (4) Ninja Twist

15. Study the figure below.

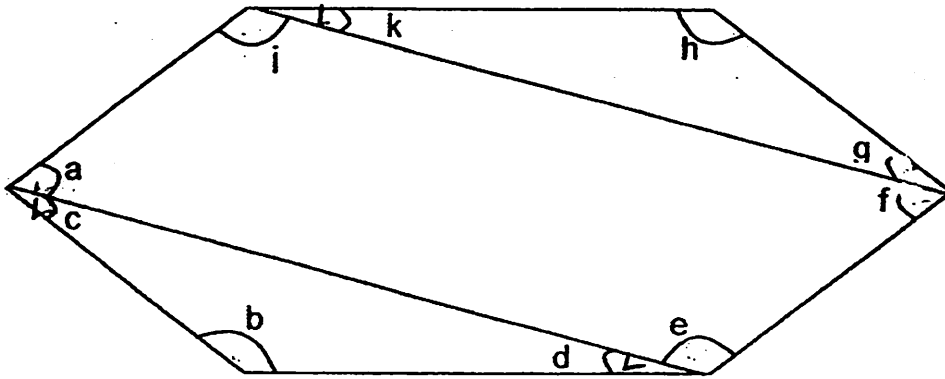

How many of the marked angles inside the figure are less than a right angle?

- (1) 6
- (2) 8
- (3) 10
- (4) 4

16. Study the figure below.

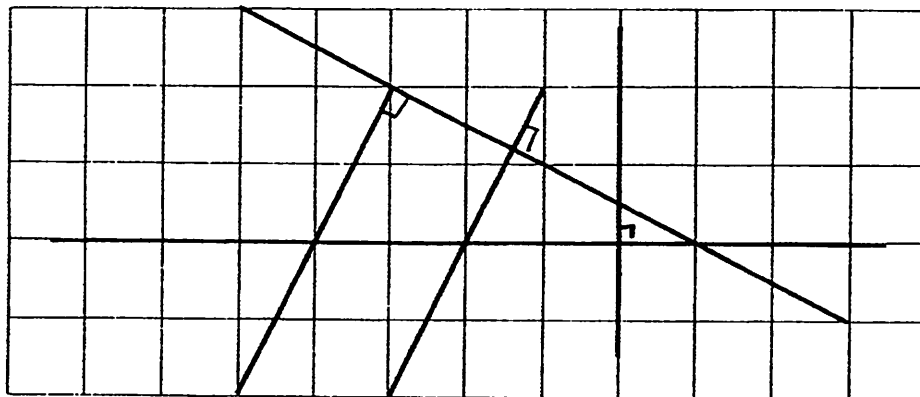

How many pairs of perpendicular lines are there?

- (1) 1
- (2) 2
- (3) 3
- (4) 4

- (1) 8 cm
- (2) 16 cm
- (3) 24 cm
- (4) 32 cm

19. The perimeter of a rectangle is 48 cm. Given that the breadth of the rectangle is half its length, find its length.

- (1) North
- (2) East
- (3) South - East
- (4) North - East

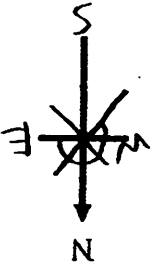

18. Janice is facing south-west, if she makes a 225° clockwise turns, she will be facing? *where will she*

- (1) 42°
- (2) 90°
- (3) 138°
- (4) 180°

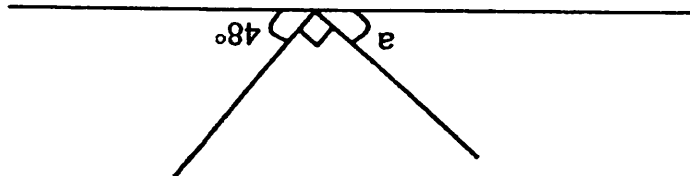

17. Find $\angle a$.

20. The figure below is made up of a rectangle and 2 identical squares.

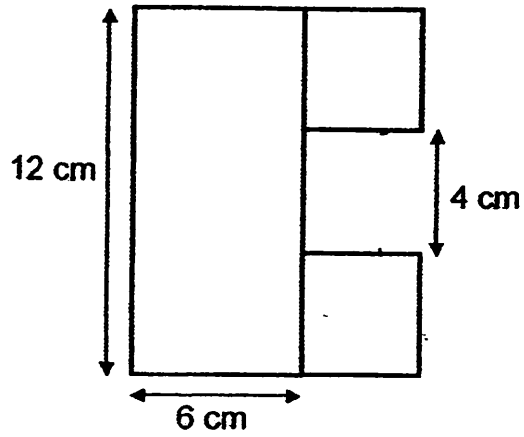

What is the perimeter of the figure ?

- (1) 36 cm
- (2) 40 cm
- (3) 44 cm
- (4) 52 cm

End of Booklet A

**Anglo-Chinese School
(Junior)**



**SEMESTRAL ASSESSMENT 2 (2011)
PRIMARY 4**

MATHEMATICS

BOOKLET B

28 October 2011, Friday Total time for Booklets A and B : 1 h 45 min

INSTRUCTIONS TO PUPILS

DO NOT TURN OVER THE PAGES UNTIL YOU ARE TOLD TO DO SO

Follow all instructions carefully.

There are 25 questions in this booklet.

Answer ALL questions.

Name:.....()

Class: 4. ()

Booklet	Possible Marks	Marks Obtained
A	40	
B1	40	
B2	20	
TOTAL	100	

Parent's Signature : _____

This question paper consists of 12 printed pages. (Inclusive of cover page)

Section B (20 × 2 marks)

For each question, write your answer in the spaces provided. Give your answer in the units stated.

21. Write 26 792 in words.

22. 32 423 , 32 763 , _____ , 33 443 , 33 783

What is the missing number in the above pattern?

23. Subtract 762 from 4020.

24. Round off the value of A to the nearest ten.

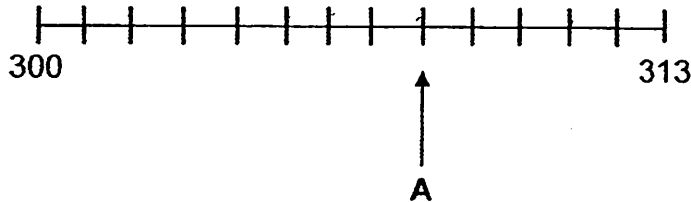

25. Study the following clues and find the number:

1. The digit 6 is in the thousands place.
2. The value of the digit 8 is 80.
3. The digit in the ones place is 1 more than the digit in the tens place.
4. The value of the digit in the hundreds place is $10 - 3$.
5. The digit in the ten thousands place is 2 less than the digit in the thousands place.

The number is _____.

26. $7\frac{3}{7} = \frac{2}{7} + \boxed{?}$

What is the missing fraction in the box?

27. Arrange the following fractions from the greatest to the smallest.

$\frac{2}{17}, \frac{2}{3}, \frac{2}{9}$

<hr/>	<hr/>	<hr/>
(greatest)		(smallest)

28. Susie bought 1 m of cloth. She used 65 cm of the cloth for a cushion cover and 25 cm of the cloth for a tie. What fraction of the cloth was left? (Give your answer in the simplest form)

29. Ahmad spends $\frac{1}{5}$ of his allowance to buy a book and saves the rest. If he saves \$8, how much is his allowance?

\$

30. Dave has $\frac{1}{2}$ as many stamps as Tom. After Tom gave 85 stamps to Dave, they had the same number of stamps. How many stamps do they have altogether?

stamps

The graph below shows the number of chickens sold by farmer Jake. Study the graph and answer questions 31 to 32.

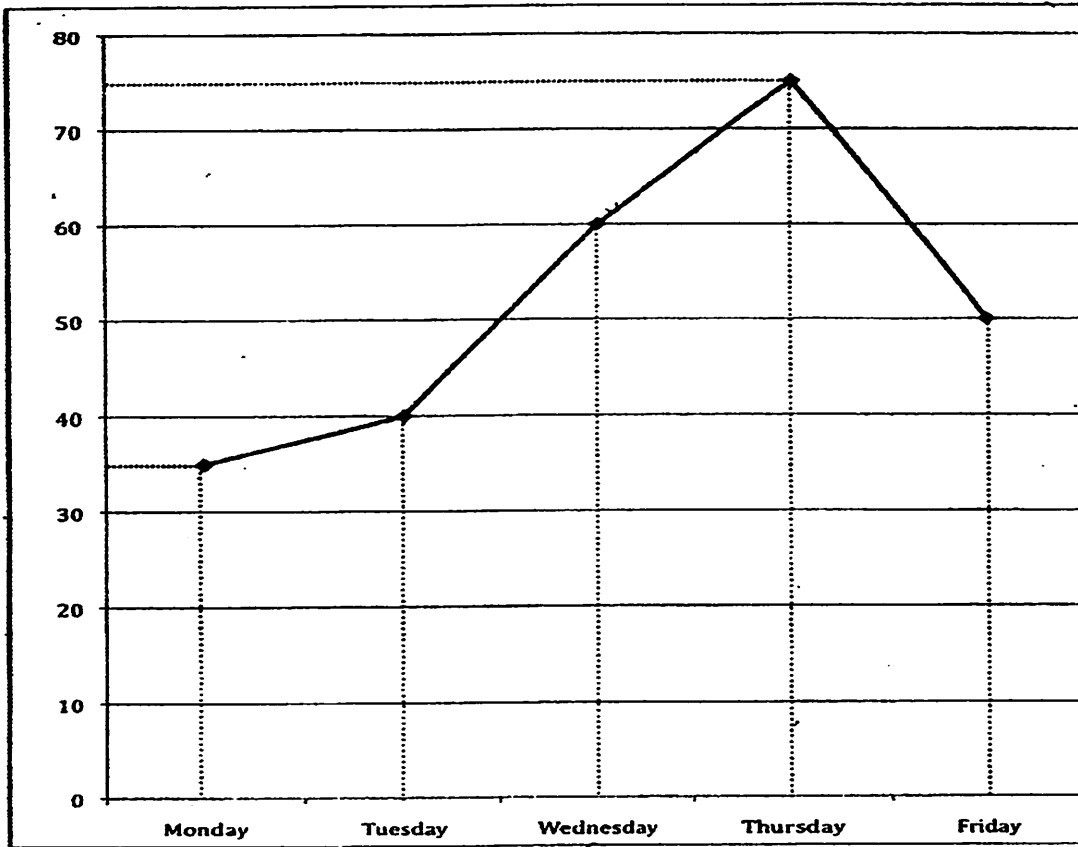

Number of chickens sold over five days

31. Which day was the greatest decrease in the sales of chickens?

32. If each chicken was sold at \$6, how much money did farmer Jake collect from the sale of his chickens on Tuesday and Wednesday?

The bar graph below shows the amount of money collected for the children's charity over a period of 6 months through the sales of coin banks. Study the graph and answer questions 33 to 34.

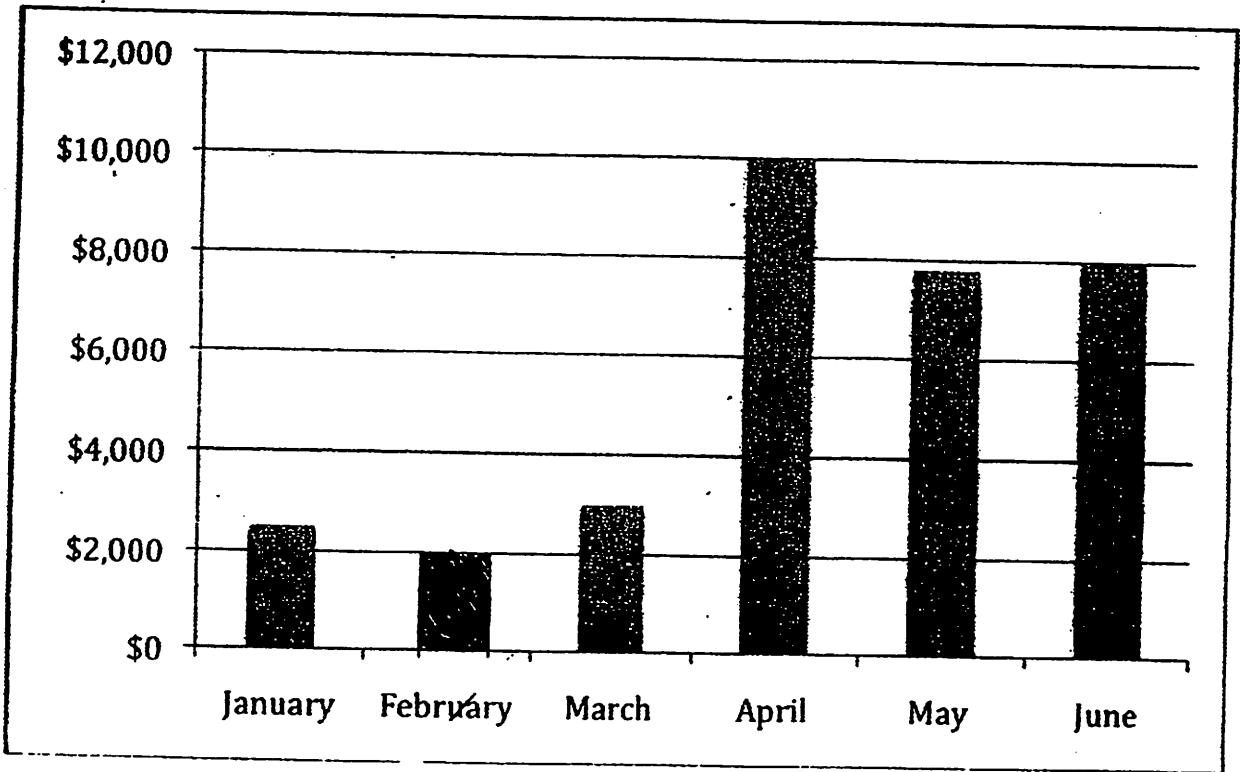

Amount of money collected through the sales of coin banks.

33. The amount of money collected for February was $\frac{1}{5}$ of the amount collected in April. Draw the bar graph in the above diagram to show the amount collected for February.

34. A coin bank was sold for \$5 each. How many coin banks were sold for the month of June?

35. ABCD is a rectangle. $\angle ABD = \angle BDC$. Find $\angle x$

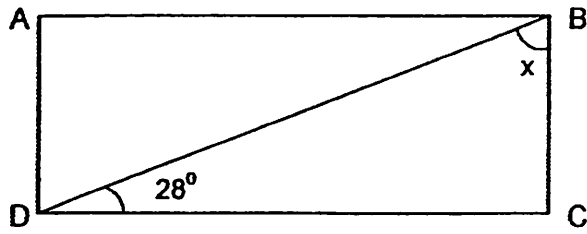

36. Identify 2 pairs of parallel lines

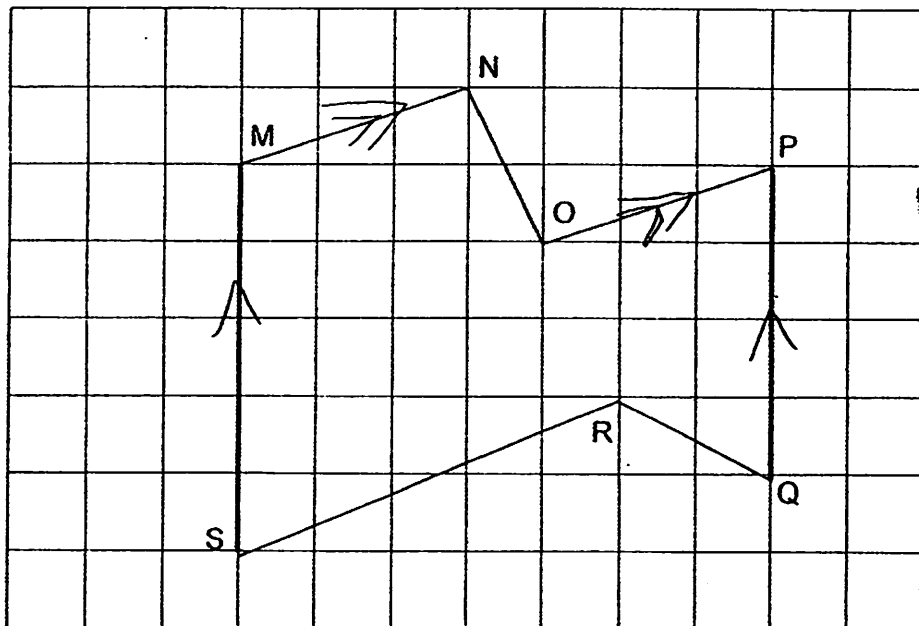

— // —

— // —

Study the diagram below and answer questions 37 to 38.

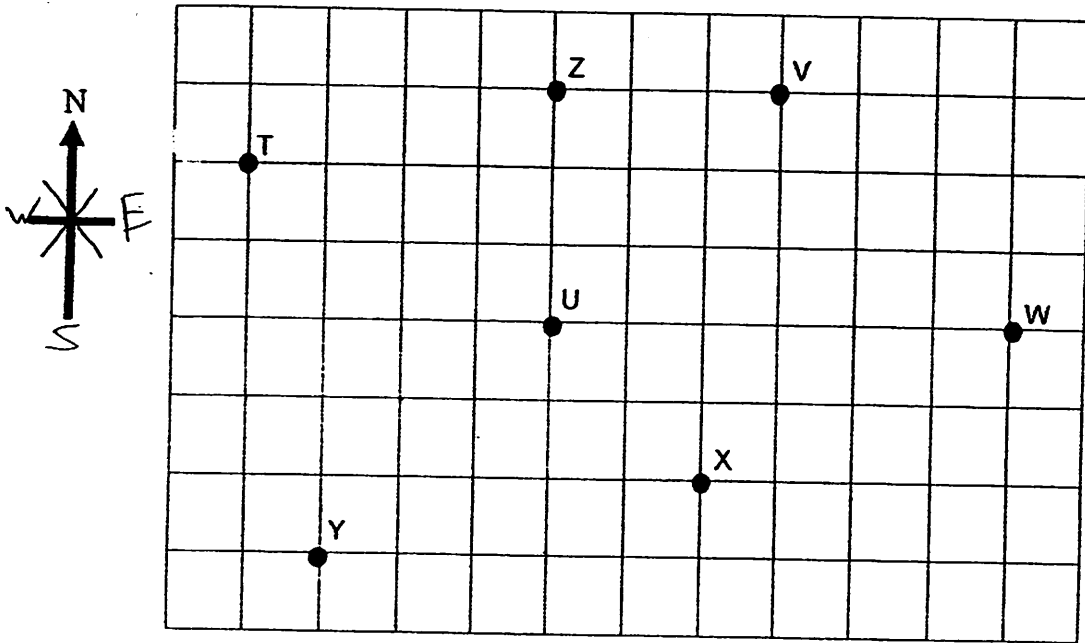

37. Point U is North-West of point _____.

38. Andrew was at point T, he took 3 steps to the South. Next he took 4 steps to the East followed by 2 steps to the South. Finally he moved 3 steps to the West. At which point would he be at the end of his journey?

39. Measure $\angle ABC$

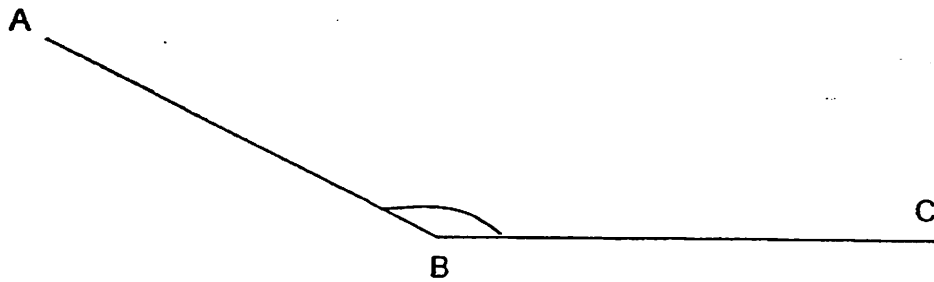

0

40. Find the perimeter of the figure.

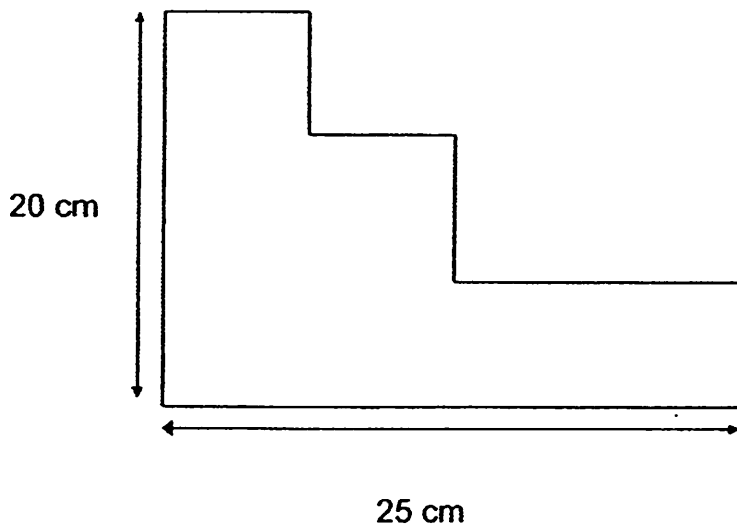

cm

Section C (5 × 4 marks)

Work out the following sums carefully. Show each step of your working clearly as marks will be given for working and relevant statements.

41. Mrs Lim baked some cookies and muffins. $\frac{3}{8}$ of her items were cookies. She baked 115 muffins. How many cookies and muffins did she bake altogether?
42. Johan spent \$33 on a shirt, a belt and a tie. Each shirt cost \$5 more than a tie and each belt cost \$8 more than a shirt. Find the cost of 6 ties.

43. Mitch had \$55 more than Chris at first. After Mitch had spent \$95, Chris had thrice as much money as Mitch left. Find the amount of money Mitch had at first.

44. Cameron and Niki had a total of 136 guppies at first. After Cameron had bought another 14 guppies and Niki had given away 40 of her guppies, both had the same number of guppies left. How many guppies did Cameron have at first?

45. Lucy saved $\frac{1}{4}$ of her monthly salary. She spends $\frac{1}{2}$ of her salary on entertainment and the rest on food.

(a) What fraction of her salary did she spend on food?

(b) If she spends \$350 more on entertainment than food, how much does she earn in a month?

ANSWER SHEET

EXAM PAPER 2011

SCHOOL : ACS
SUBJECT : PRIMARY 4 MATHEMATICS

TERM : SA1

Q1	Q2	Q3	Q4	Q5	Q6	Q7	Q8	Q9	Q10	Q11	Q12	Q13	Q14	Q15	Q16	Q17
3	4	4	4	3	3	3	3	2	3	3	4	1	4	1	3	1

Q18	Q19	Q20
2	2	4

21) Twenty-six thousand, seven hundred and ninety-two

22) 33103

23) 3258

24) 310

25) 46789

26) $7\frac{1}{7}$

27) $\frac{2}{3}$, $\frac{2}{9}$, $\frac{2}{17}$

28) $\frac{1}{10}$

29) \$10

30) 510 stamps

31) Friday

32) \$600

33) February = \$2000

34) 1600

35) 62°

36) MS//PQ
MN//OP

37) X

38) Y

39) 154°

40) 90cm

41) $115 \div 5 = 23$

$$23 \times 3 = 69$$

$$115 + 69 = 184$$

She baked 184 cookies and muffins altogether.

42) $\$5 + \$8 = \$13$

$$\$13 + \$5 = \$18$$

$$\$33 - \$18 = \$15$$

$$\$15 \div 3 = \$5$$

$$\$5 \times 6 = \$30$$

The cost of 6 ties is \$30.

43) $\$95 - \$55 = \$40$

$$\$40 \div 2 = \$20$$

$$\$20 \times 3 = \$60$$

$$\$60 + \$55 = \$115$$

Mitch had \$115 at first.

44) $40 + 14 = 54$

$$136 - 54 = 82$$

$$82 \div 2 = 41$$

Cameron had 41 guppies at first.

45) a) $\frac{1}{4} + \frac{1}{2} = \frac{1}{4} + \frac{2}{4} = \frac{3}{4}$

$$\frac{4}{4} - \frac{3}{4} = \frac{1}{4}$$

She spends $\frac{1}{4}$ of her salary on food.

$$\text{b) } \frac{1}{2} - \frac{1}{4} = \frac{2}{4} - \frac{1}{4} = \frac{1}{4}$$

$$4 \times \$350 = \$1400$$

She earns \$1400 in a month.