

METHODIST GIRLS' SCHOOL (PRIMARY)

Founded in 1887



END-OF-YEAR EXAMINATION 2011 PRIMARY 4 MATHEMATICS BOOKLET A

Total Time: 1 h 45 minutes

INSTRUCTIONS TO CANDIDATES

Do not turn over this page until you are told to do so.
Follow all instructions carefully.
Answer all questions.

Name: _____ ()

Class: Primary 4. _____

Date: 11 October 2011

PARENT'S SIGNATURE:

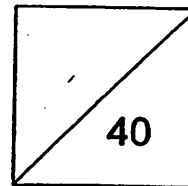

This booklet consists of 7 printed pages including this page.

Section A

Questions 1 to 20 carry 2 marks each. For each question, four options are given. One of them is the correct answer. Make your choice (1, 2, 3 or 4). Shade the correct oval (1, 2, 3 or 4) on the Optical Answer Sheet.

(40 marks)

1 The value of the digit 4 in 74 328 is _____.

- (1) 40
- (2) 400
- (3) 4 000
- (4) 40 000

2 Which of the following is a factor of both 60 and 75?

- (1) 10
- (2) 15
- (3) 20
- (4) 25

3 $17.08 = 17 + \frac{8}{\boxed{?}}$

What is the missing number in the box?

- (1) 1
- (2) 10
- (3) 100
- (4) 1 000

4 What fraction of the figure is shaded?

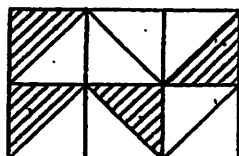

- (1) $\frac{1}{4}$
- (2) $\frac{1}{3}$
- (3) $\frac{1}{2}$
- (4) $\frac{3}{4}$

(Go on to the next page)

- 5 Which one of the following fractions is in its simplest form?
- (1) $\frac{5}{7}$
 - (2) $\frac{3}{6}$
 - (3) $\frac{6}{9}$
 - (4) $\frac{2}{10}$
- 6 Which of the following decimals is arranged from the smallest to the greatest?
- (1) 0.36, 0.63, 6.03, 6.3
 - (2) 0.36, 0.63, 6.3, 6.03
 - (3) 0.63, 0.36, 6.03, 6.3
 - (4) 0.63, 0.36, 6.3, 6.03
- 7 The area of a square is 64 m^2 . What is the perimeter of this square?
- (1) 8 m
 - (2) 16 m
 - (3) 32 m
 - (4) 128 m
- 8 Jenny had 236 stickers. She kept 110 for herself and gave the rest to her friends. Each friend received 7 stickers. How many friends did she have?
- (1) 16
 - (2) 17
 - (3) 18
 - (4) 126

Study the table carefully and answer questions 9 and 10.
The table below shows the number of children who have long hair in three Primary 4 classes.

| | No. of children with long hair | No. of children with short hair |
|-----|--------------------------------|---------------------------------|
| 4.1 | 26 | ? |
| 4.2 | 18 | 20 |
| 4.3 | 32 | 8 |

- 9 How many children have long hair in Primary Four?
- (1) 60
(2) 66
(3) 70
(4) 76
- 10 The total number of children with short hair is the same as the total number of children in Primary 4. How many children in Primary 4.1 have short hair?
- (1) 12
(2) 14
(3) 28
(4) 4
- 11 Which letter in the word below has both parallel and perpendicular lines?

L E A N

- (1) L
(2) E
(3) A
(4) N
- 12 Express 2 minutes 15 seconds in seconds.
- (1) 75 seconds
(2) 120 seconds
(3) 135 seconds
(4) 215 seconds

(Go on to the next page)

- 13 How many right angles are there inside the shape shown below?



- (1) 1
 (2) 2
 (3) 3
 (4) 4
- 14 Mrs Lim has 2 ℓ of milk. She drank 0.5 ℓ and her daughter drank 0.36 ℓ. How many litres of milk has she left? Round off your answer to the nearest tenth.
- (1) 0.9 ℓ
 (2) 1.0 ℓ
 (3) 1.1 ℓ
 (4) 1.2 ℓ
- 15 Which one of the following numbers when rounded off to 2 decimal places is 123.64?
- (1) 123.634
 (2) 123.639
 (3) 123.645
 (4) 123.649
- 16 The figure below is not drawn to scale. AB is perpendicular to AD. Find $\angle CAB$.

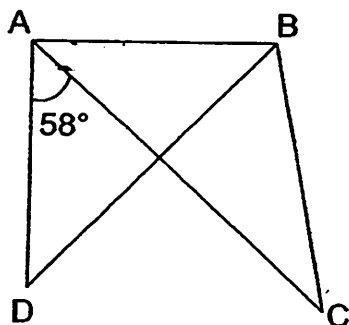

- (1) 32°
 (2) 42°
 (3) 48°
 (4) 58°

- 17 Look at the figures below. Which figure does not have any lines of symmetry?

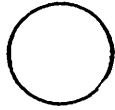

Figure A



Figure B

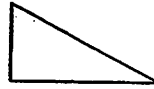

Figure C

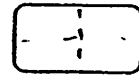
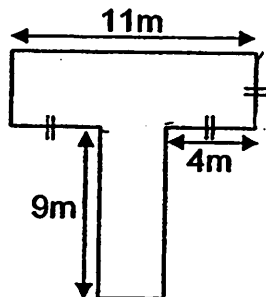

Figure D

- (1) Figure A
 (2) Figure B
 (3) Figure C
 (4) Figure D

- 18 The figure below is made up of 2 rectangles. Find the area of the figure.



- (1) 71 m^2
 (2) 72 m^2
 (3) 80 m^2
 (4) 85 m^2

- 19 Mei Mei is standing at the MRT station facing the cake shop. She turns 135° anti-clockwise. Where will she be facing?

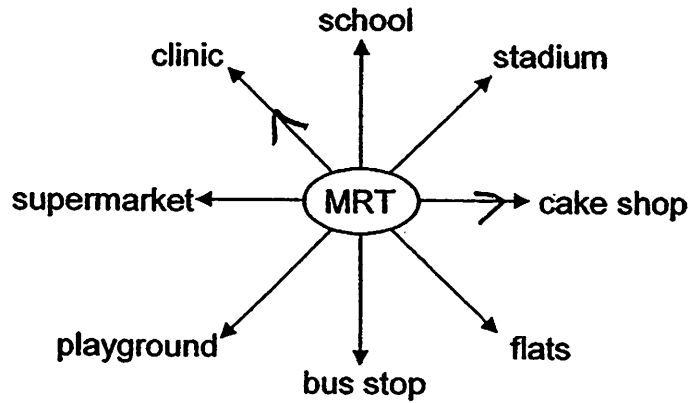

- (1) clinic
 (2) school
 (3) flats
 (4) playground
- 20 The figure below is made up of 2 squares of side 8 cm and 6 cm respectively. What is the area of the unshaded part of the figure?

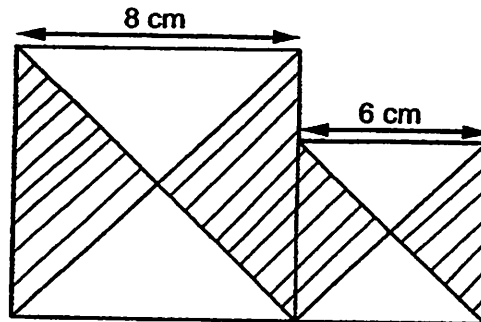

- (1) 36 cm^2
 (2) 48 cm^2
 (3) 50 cm^2
 (4) 64 cm^2

METHODIST GIRLS' SCHOOL (PRIMARY)

Founded in 1887



END-OF-YEAR EXAMINATION 2011 PRIMARY 4 MATHEMATICS BOOKLET B

Total Time: 1 h 45 minutes

INSTRUCTIONS TO CANDIDATES

Do not turn over this page until you are told to do so.

Follow all instructions carefully.

Answer all questions.

Name: _____ ()

Class: Primary 4. _____

Date: 11 October 2011

| | |
|-----------|-----|
| BOOKLET A | 40 |
| BOOKLET B | 40 |
| BOOKLET C | 20 |
| TOTAL | 100 |

This booklet consists of 7 printed pages including this page.

Section B

Questions 21 to 40 carry 2 marks each. Write your answers in the space provided.
For questions which require units, give your answers in the units stated.

(40 marks)

21 Fill in the blank with the correct number in the number pattern below.

725, 741, 757, _____ 789

Ans: _____

22 Round off 9 563 to the nearest ten.

Ans: _____

23 $4\,608 \div 8 =$ _____

Ans: _____

24 Express $4\frac{3}{5}$ as an improper fraction.

Ans: _____

(Go on to the next page)

- 25 What is the value of $\frac{5}{12} + \frac{3}{4}$
Express your answer as a mixed number.

Ans: _____

- 26 There are 210 children in Primary 4. $\frac{4}{7}$ of them take the school bus to school. How many children do not take the school bus to school?

Ans: _____

- 27 Express 0.06 as a fraction in its simplest form.

Ans: _____

- 28 Write the decimal represented by A.

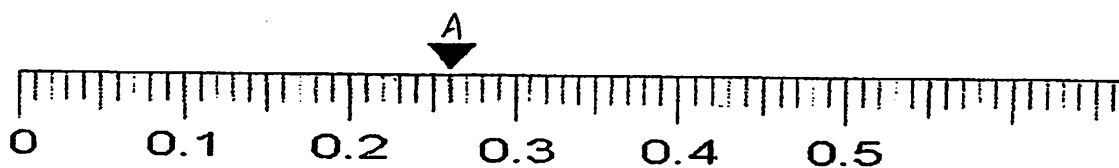

Ans: _____

(Go on to the next page)

- 29 Express the time shown on the clock below using the 24-hour clock format.



Ans: _____

- 30 Mr Lim drove from Singapore to Kuala Lumpur. After driving for 2 h 15 min, he stopped to rest for 20 minutes. He continued his journey for another 1 h 45 min and arrived at Kuala Lumpur at 14 00. At what time did he leave Singapore? Express your answer using the 24-hour clock.

Ans: _____

- 31 One of the lines in the figure is parallel to \overline{FC} . Which line is parallel to \overline{FC} ?

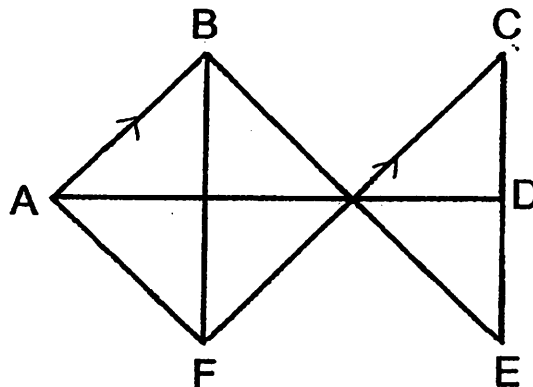

Ans: _____

(Go on to the next page)

- 32 In the figure below, which angle is smaller than a right angle?

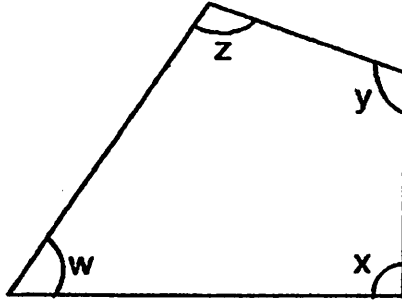

Ans: _____

- 33 How many pairs of parallel lines are there in the figure below?

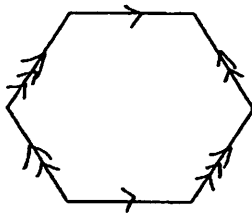

Ans: _____

- 34 Draw a line PQ parallel to AB passing through point M.

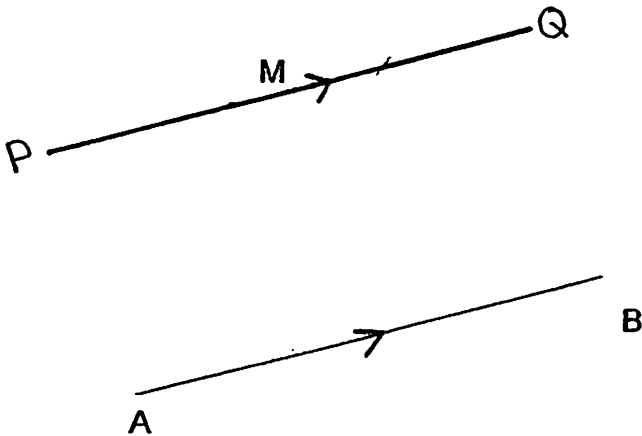

Study the graph below carefully and answer questions 35 and 36.

The line graph below shows the number of siblings the pupils in Primary 4A have.

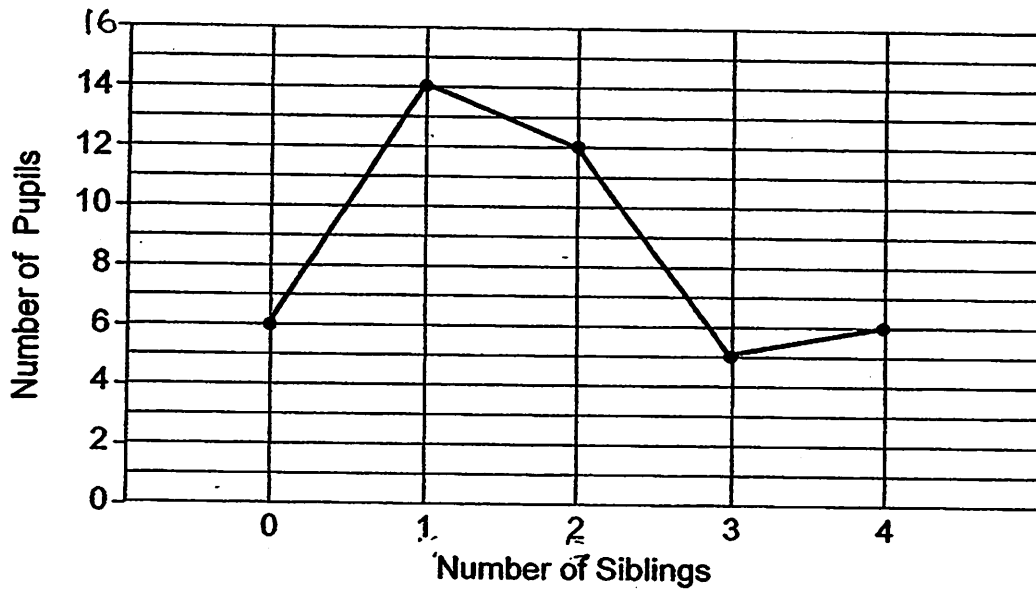

35 How many pupils are there in Primary 4A?

Ans: _____

36 How many pupils have 2 or fewer siblings?

Ans: _____

37 Find the perimeter of the figure below.
(All lines meet at right angles)

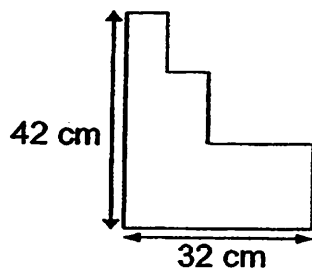

Ans: _____ cm

(Go on to the next page)

- 38 The perimeter of a rectangle is 84 cm. Its length is 3 times as long as its breadth. What is the breadth of the rectangle?

Ans: _____ cm

- 39 How many lines of symmetry are there in the figure below?

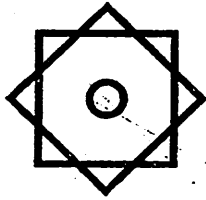

Ans: _____

- 40 The breadth of a rectangular piece of paper is 10 cm. 3 identical rectangles were cut from it, leaving 20 cm² of paper. What is the width of rectangular piece X?

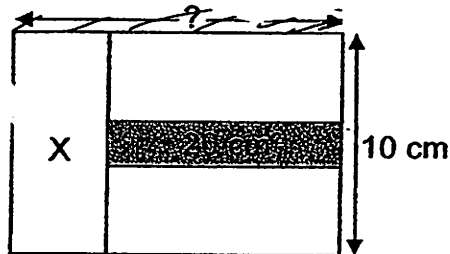

Ans: _____ cm

The following information is for your information only. It is not intended to be used as a substitute for professional advice.

W.C. 1-8-1
W.C. 1-8-1
W.C. 1-8-1

W.C. 1-8-1

W.C. 1-8-1

W.C. 1-8-1

W.C. 1-8-1

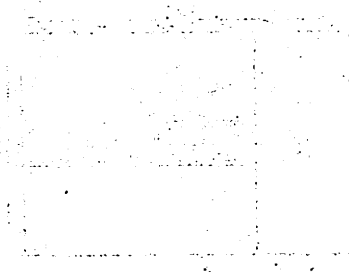

METHODIST GIRLS' SCHOOL (PRIMARY)

Founded in 1887



END-OF-YEAR EXAMINATION 2011 PRIMARY 4 MATHEMATICS BOOKLET C

Total Time: 1 h 45 minutes

INSTRUCTIONS TO CANDIDATES

Do not turn over this page until you are told to do so.

Follow all instructions carefully.

Answer all questions.

Name: _____ ()

Class: Primary 4. _____

Date: 11 October 2011

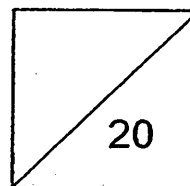

This booklet consists of 4 printed pages including this page.

Section C

Questions 41 to 45 carry 4 marks each. Show your working clearly in the space provided for each question and write your answers in the space provided. The number of marks available is shown in brackets [] at the end of each question or part-question. (20 marks)

- 41 The total capacity of 3 pails and 4 bottles is 26 l. The capacity of each pail is 3 times as much as the bottle. What is the capacity of each pail?

Ans: _____ [4m]

- 42 A sum of money was shared among 3 children, Ann, Ben and Cindy. Ann received $\frac{1}{4}$ of the money. Ben received $\frac{1}{3}$ of the remainder. The rest went to Cindy. If Cindy received \$27, how much was the sum of money?

Ans: _____ [4m]

(Go on to the next page)

- 43 Samy and Raji were given the same amount of pocket money each week. Samy spent \$17 while Raji spent \$5. Raji then had 4 times as much money as Samy. How much money was each boy given at first?

Ans: _____ [4m]

- 44 The total cost of 2 similar water bottles and 4 similar lunch boxes is \$14.50. A water bottle and a lunch box cost \$6.50. What is the cost of 4 lunch boxes?

Ans: _____ [4m]

(Go on to the next page)

- 45 The figure shown below is a square piece of art paper. A design is created using shaded squares. The area of each shaded square in the design is 25 cm^2 .

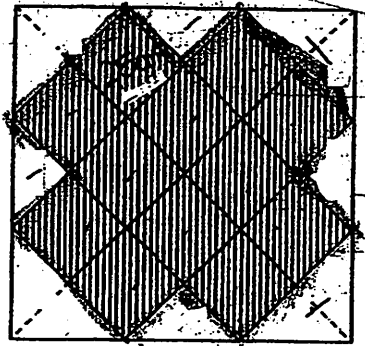

- (a) What is the area of the art paper?
(b) What is the perimeter of the design?

Ans: (a) _____ [2m]

(b) _____ [2m]

End of Paper

ANSWER SHEET

EXAM PAPER 2011

SCHOOL : MGS
SUBJECT : PRIMARY 4 MATHEAMATICS

TERM : SA2

| | | | | | | | | | | | | | | | | |
|----|----|----|----|----|----|----|----|----|-----|-----|-----|-----|-----|-----|-----|-----|
| Q1 | Q2 | Q3 | Q4 | Q5 | Q6 | Q7 | Q8 | Q9 | Q10 | Q11 | Q12 | Q13 | Q14 | Q15 | Q16 | Q17 |
| 3 | 2 | 3 | 2 | 1 | 1 | 3 | 3 | 4 | 1 | 1 | 3 | 2 | 3 | 2 | 1 | 3 |

| | | |
|-----|-----|-----|
| Q18 | Q19 | Q20 |
| 1 | 1 | 3 |

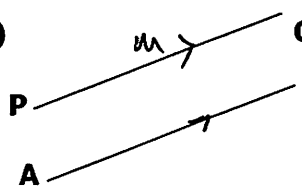
- | | | | | |
|--------------|--------------|----------|--|----------------------------------|
| 21)773 | 22)9560 | 23)576 | 24)23/5 | 25)1 ¹ / ₆ |
| 26)90 | 27)3/50 | 28)0.26 | 29)1530 | 30)0940 |
| 31)AB | 32)∠W | 33)3 | 34) | |
| 35)43 pupils | 36)32 pupils | 37)148cm |  | |
| 38)10.5cm | 39)8 | 40)4cm | | |

41)26L = 26000ml
 $26000\text{ml} \div 13 = 2000\text{ml}$
 $2000\text{ml} \times 3 = 6000\text{ml}$
 = 6L
 The capacity of each pail is 6L.

42)2u → \$27.00
 $1u \rightarrow \$27.00 \div 2u = \13.50
 $4u \rightarrow \$13.50 \times 4u = \54.00
 The sum of money was \$54

43)\$17 - \$5 = \$12
 $3u \rightarrow \$12$
 $1u \rightarrow \$12 \div 3u = \4
 $\$4 + \$17 = \$21$
 Each boy was given \$21 at first.

44)\$6.50 x 2 = \$13.00
 $\$14.50 - \$13.00 = \$1.50$
 $\$1.50 \div 2 = \0.75
 $\$0.75 \times 4 = \3.00
 The cost of 4 lunch boxes is \$3

45)a) $12 + 6 = 18$
 $18 \times 25\text{cm}^2 = 450\text{cm}^2$
 The area of the art paper is 450cm²
 b) $5\text{cm} \times 5\text{cm} = 25\text{cm}^2$
 $16 \text{ sides} \times 5\text{cm} = 80\text{cm}$
 The perimeter of the design is 80cm.